

وزارة التعليم العالي والبحث العلمي

الجامعة العراقية

كلية العلوم الإسلامية

# تصميم أداة متنقلة لمتابعة نظام إرواء باستخدام تقنية zigBee

بحث مقدم من قبل

المدرس (محمد عبدالجبار عبدالوهاب)

٢٠١٥ م

بغداد

١٤٣٦ هـ

**The Ministry of Higher  
Education and Scientific  
Research**

**Iraqia University**

**Faculty of Islamic Sciences**

# **Design Portable Device for Irrigation System using ZigBee**

**Research presented by**

**Mohammed Abdul Jabar Abdul Wahab**

**1436**

**2015**

## **Design Portable Device for Irrigation System using ZigBee**

**Mohammed Abdul Jabar Abdul Wahab**

### **Abstract**

The smart irrigation systems considered as one of the most new significant technologies in this century to control the watering system and help the plants to grow. This research is focused on the design of an irrigation system based on one of the wireless sensor network (WSN) technologies which is ZigBee technology. The proposed design has an autonomous soil moisture monitoring system with wireless sensor network and ZigBee interfacing for transmitting data from slave to master side. In addition to that, the purpose of monitoring system suggested in this work is to measure and display the ratio of water soil in real-time.

Soil moisture sensors have been used in this proposed design for measuring changes in soil volumetric water and changes ration of water found in the soil was evaluated under outdoor environment conditions for two averages of watered soil (40% and 70%). The real-time data of watered soil has been collected for two different value of watering (40 and 70%) and data collected vary based on location of the sensor in soil and how much soil dried in that point. It is found that the water ratio (70%) is better than (40%) from the experimental results.

**Keywords:** WSN, moisture sensor, Microcontroller, ZigBee

### **1. Introduction**

There are various irrigation techniques and these techniques use drippier and sprinkler to provide the entire field uniformly with water, so that each plant has the quantity of water it needs, neither too much nor too little. Smart irrigation systems using various

wireless sensor network techniques in these recent days[1]. One of the most interested fields in smart irrigation system, is used for schedule irrigation for drip/Trickle watering system and other applications varies in data transfer types and in type of control with analysis data. Applications in surface irrigation where water is applied and distributed over the soil surface by gravity. Water consumers in agriculture water, which make it very important for the irrigation management to pay attention on the water distribution optimization of irrigation district[2]. The implementation of Wireless sensor networks (WSN) with irrigation system reduce and simplify the wiring and harness, allow monitoring the data, hazardous, unwired or remote areas and locations. The WSN represented in arrays of electronic devices with sensing capabilities that are interconnected using a radio network. There are a lot of designs, ranging from micro-devices with embedded sensors to complete self-powered acquisition devices that support a large variety of external sensors[1].

## **2. Wireless Sensor Networks**

While many sensors connect to controllers and processing stations directly (e.g., using local area networks) lead to increasing number of sensors communicate to collected data wirelessly to a centralized processing station.

This is important for many network applications require hundreds or thousands of sensor nodes, often deployed in remote and inaccessible areas. Therefore, a wireless sensor has not only a sensing component, but also on-board processing, communication, and storage capabilities. With these enhancements, a sensor node is often not only responsible for data collection, but also for network analysis, correlation, and fusion of its own sensor data and data from other sensor nodes. When many sensors cooperatively monitor large physical environments, they form a wireless sensor network (WSN). Sensor nodes communicate not only with each other but also with a base station (BS) using their wireless radios, allowing them to disseminate their sensor data for remote processing, visualization, analysis, and storage systems. For example, Figure (1) shows two sensor fields monitoring two different geographic regions and connecting to the Internet using their base stations. The capabilities of sensor nodes in a WSN can vary widely, that is, simple sensor nodes may monitor a single physical phenomenon, while

more complex devices may combine many different sensing techniques (e.g., acoustic, optical, magnetic)[4].

They can also differ in their communication capabilities, for example, using ultrasound, infrared, or radio frequency technologies with varying data rates and latencies [5]. While simple sensors may only collect and communicate information about the observed environment, more powerful devices (i.e., devices with large processing, energy, and storage capacities) may also perform extensive processing and aggregation functions. Such devices often assume additional responsibilities in a WSN, for example, they may form communication backbones that can be used by other resource-constrained sensor devices to reach the base station.

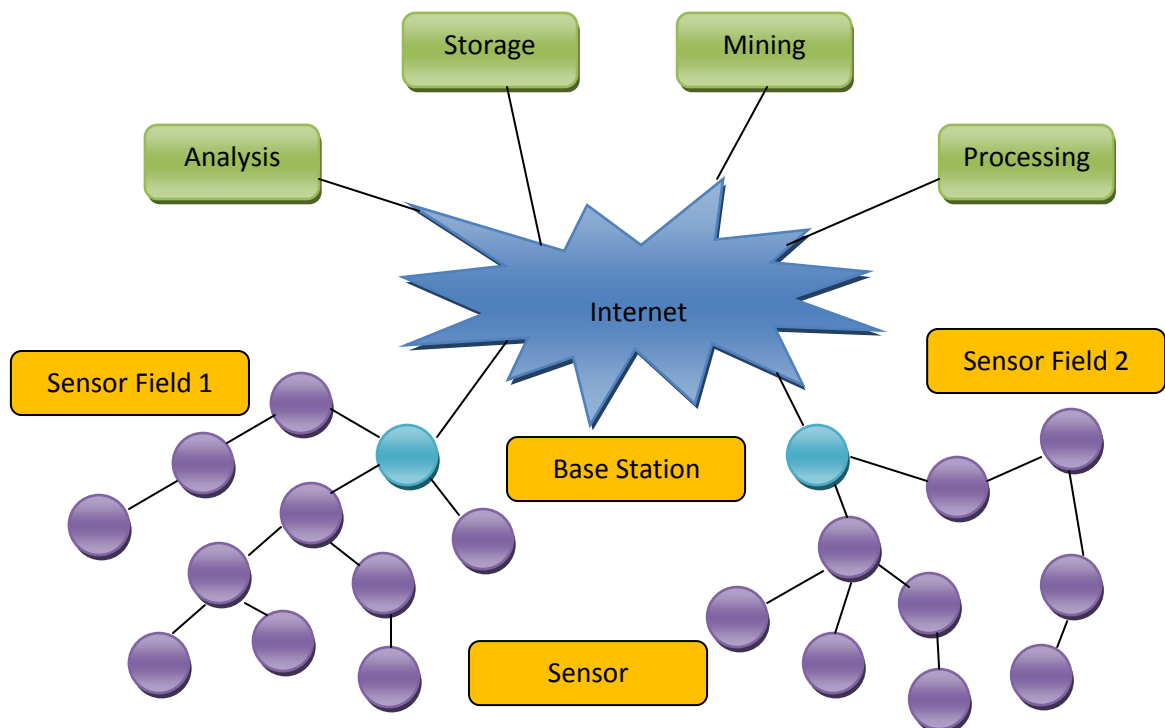

Fig. (1) Wireless Sensor Network

Finally, some devices may have access to additional supporting technologies, for example, Global Positioning System (GPS) receivers, allowing them to accurately determine their position. However, such systems often consume too much energy to be feasible for low-cost and low-power sensor nodes[3].

### 3. Previous Work

In 2009, Zulhani Rasin et al. using Zigbee technology to monitoring irrigation [6]. They have tried to keep water suited level. Results established the suitability of Zigbee Alliance for monitoring big area.

Jyothipriya A.N. and T.P. Saravanabava suggested a drip irrigation control system using GSM based ZigBee [7]. Results display that the system preserved water.

In 2011, Aqeel ur-Rehman et al. deliberated a evaluation on WSN usage in several agricultural applications such as: irrigation, fertilization, pest control, and horticulture [8]. It showed reasons behind using WSN in agriculture. Only general concepts and brief description were introduced.

### 4. Proposed Work

The scope of work of this project consists of hardware and software. The essential idea is to supply user-controller on the hardware receiver board from the transmitter board that contains sensors that will send current condition of the plant to the receiver. The transmitter board consists of soil humidity sensors connected to client board which is contents a Zigbee module to transmit data. The main processor that controls the transmitter system is PIC18F45k22. The receiver board consists same controller used in client side, and the main operation of this board is getting data from transmitter side and send in the same time to PC for monitoring via serial port. The receiver side contains a database for saving the data collected by each sensor with time. The phases of proposed work has shown in figure (2) below.

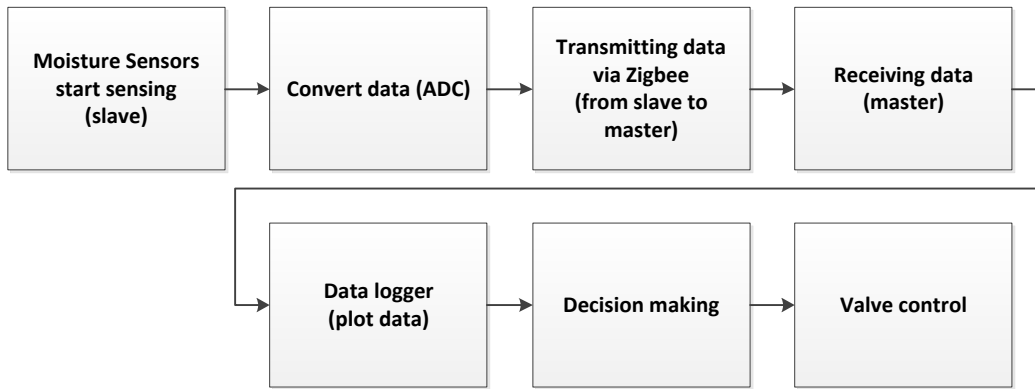

Fig. (2) Conceptual Diagram of Proposed Design

Figure (3) express a common view of this proposed work.

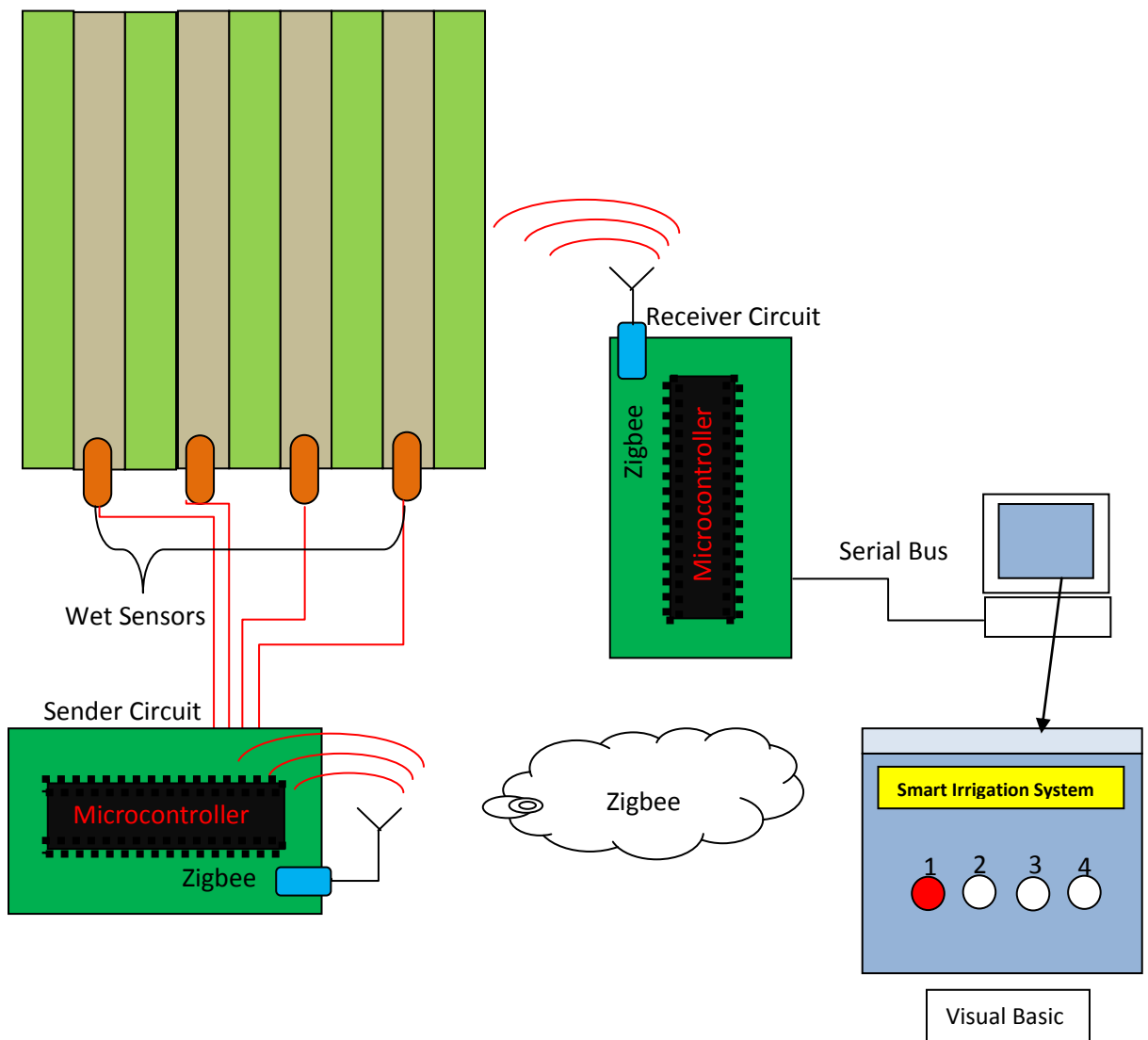

Fig. (3) Block Diagram Representations Procedure of Proposed Work

The main concept of proposed work is to focus on monitoring data of soil and take discussion to control the solenoid for watering, also, using Zigbee technology for transceiver data from slave to master. Figure (4) shows procedure of proposed work.

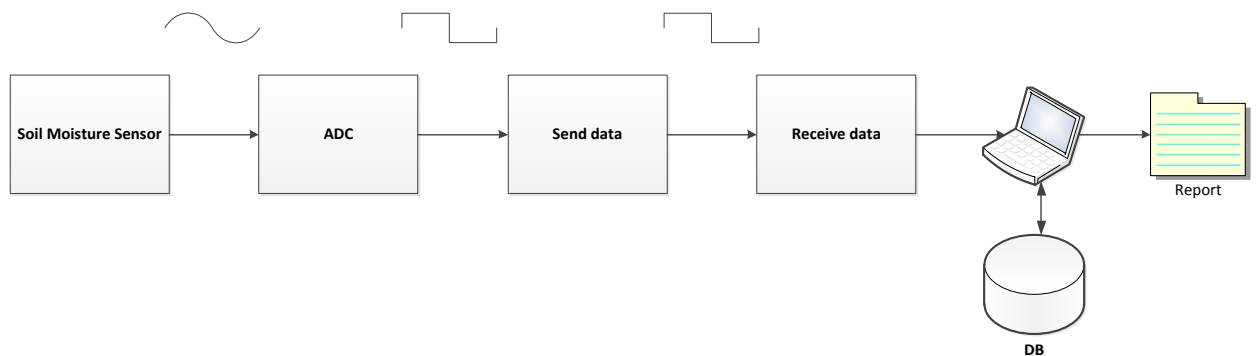

Fig. (4) Block Diagram Representations Procedure of Proposed Work

A high performance microcontroller PIC18F45K22 has been chosen to be the core and main processor for our proposed. PIC18F45K22 microcontroller from Microchip has many qualifications that served our proposed system. The main features of the system are the Flash Memory size, RAM size, CPU speed, and Digital communication peripherals as the system has used UART interface with ZigBee module and SPI interface with Ethernet controller module plus Ethernet protocol stack has been loaded on the MCU.

The ZigBee Chip CC2530 integrated into DRF1605 board has been chosen to provide the ZigBee protocol communication between the Base Station and End Nodes. DRF1605 ZigBee module provide serial UART interface for direct send/receive data communication with microcontrollers. This module to be used for both client and server side transwers, it has been configured as a Coordinator with a specific PAN ID using the software application provided with the module.



- **Practical Operations**

- 1- Zigbee connection:**

- scanning: search and detect for devices in range. Any Zigbee device has a MAC address.
- Pairing: Each Zigbee device gets coupled with the local Zigbee device. This needs to be done during entering a code of both sides.
- Connection: The connection used to establish connection between pair of Zigbee devices and exchange data.

- 2- Soil Sensor:**

There has been used four moisture soil sensors to sense how the soil is watered. The type of sensing data is analogue and it needs to be converted to a digital form.

- 3- ADC:**

There are differential analogue voltage inputs, 0-5V input voltage range, no zero adjustment, adjusted to convert smaller analogue voltage span to 8 bit resolution. If the input signal is 5v then the maximum equivalent will be 255 in digital.

- 4- Slave Processing:**

A microcontroller in a slave circuit gets the data of each sensor, and does loop for reading data from all four sensors sequentially, and sends them via Zigbee to the master circuit.

- 5- Master Processing:**

The circuit of master consists of a microcontroller and it is interfaced to the PC via serial port used to transfer the data that are received from the slave to be displayed and saved in databases found in PC.

- 6- Monitoring System:**

The designed system is working at run-time when circuits (slave, master, and connection established) are powered on. The designed monitor has been used to display events of sensing data, and save the data in databases to compare and plot them.

The database (MDB) has been used to collect the data, also to retrieve these data for plotting purpose. Instead of that, the calibration has been taken in consideration for the reading data, where the minimum reading is (0) no water in soil, and the maximum (100) means the soil filled with water. We've calibrate the sensor by reading sensor via ADC which can read 1024 levels between 0V and 5V, and so the value returned by the analog read function ( $5V/1024=0,0049V$ ), so, (1 step = 4.9mV).

## 5. Hardware Schematic Design and Description

The main electronics parts used in proposed work are microcontroller and Zigbee model. The microcontroller model is 18F45k22 which include SPI bus which suitable for connect Zigbee model with. The Zigbee model (MRF24J40MA) is 2.4GHz RF transceiver

The first circuit design is slave which has moisture sensors used to sensing the water ratio in soil in real time, and then transmit the data to master circuit. The schematic circuit design of slave is shown in figure (5) below.

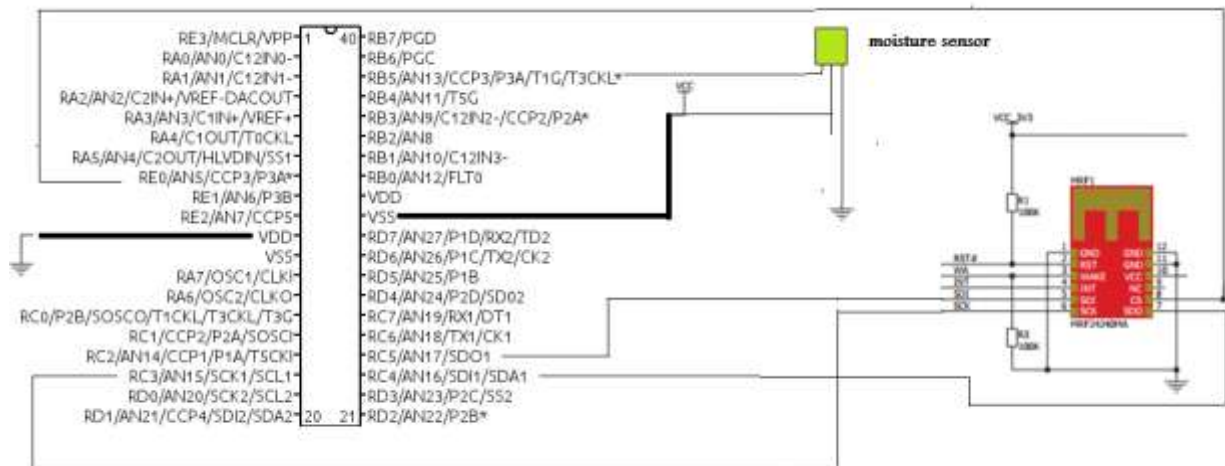

Figure (5) schematic circuit design of slave side

To determining the operation in real design, we've design demonstration of greenhouse for slave side operation as shown in figure (6).

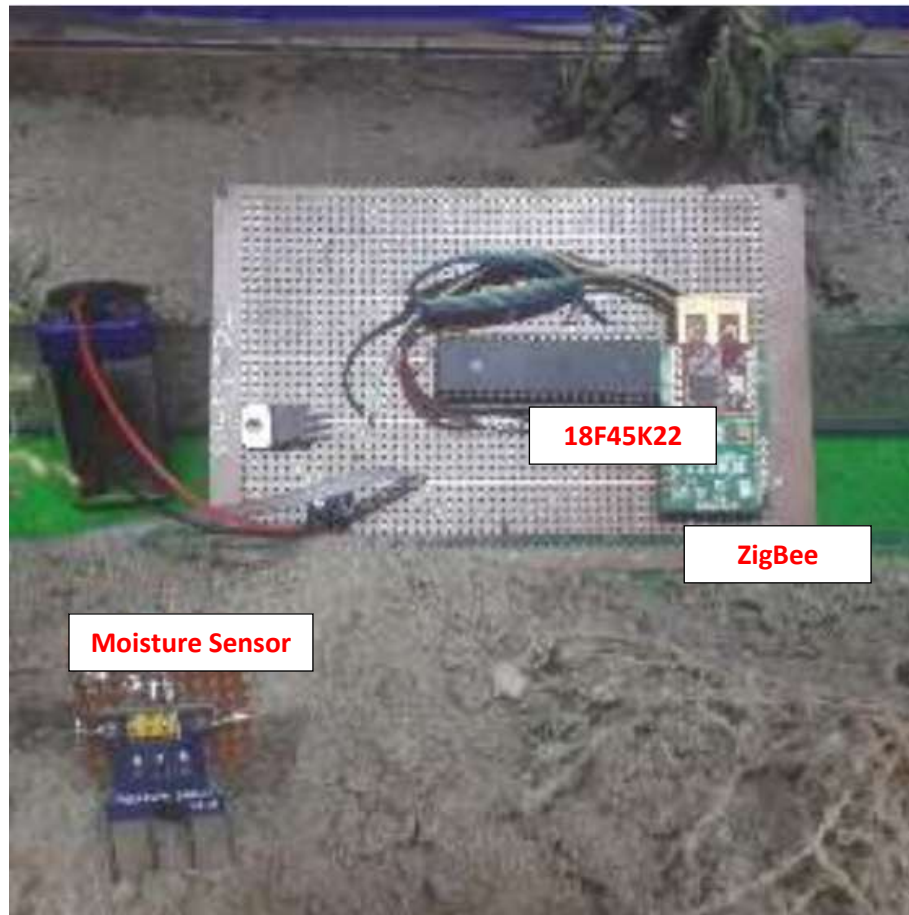

Figure (6) model design of greenhouse with electronic circuit

The second circuit design is master which connected to PC via serial port using MAX232 TTL to serial converter. Also, this circuit has two main parts as in slave, microcontroller and Zigbee, the Zigbee model (MRF24J40MA) for compatibility with Zigbee model in slave side to transceiver data as shown in figure (7).

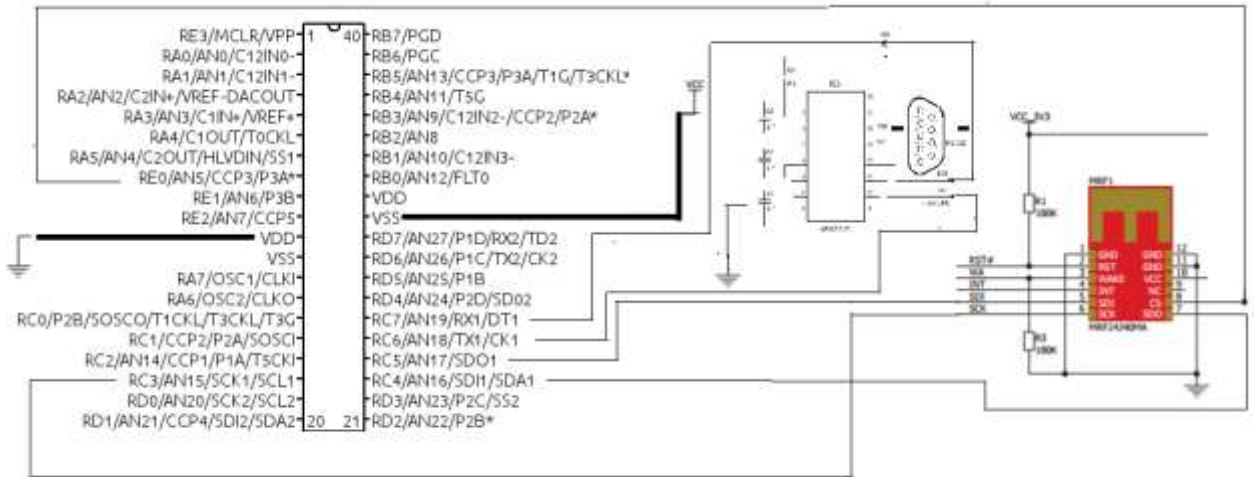

Figure (7) schematic circuit design of Master side

The interface circuit design to monitor system is shown in figure (8) below.

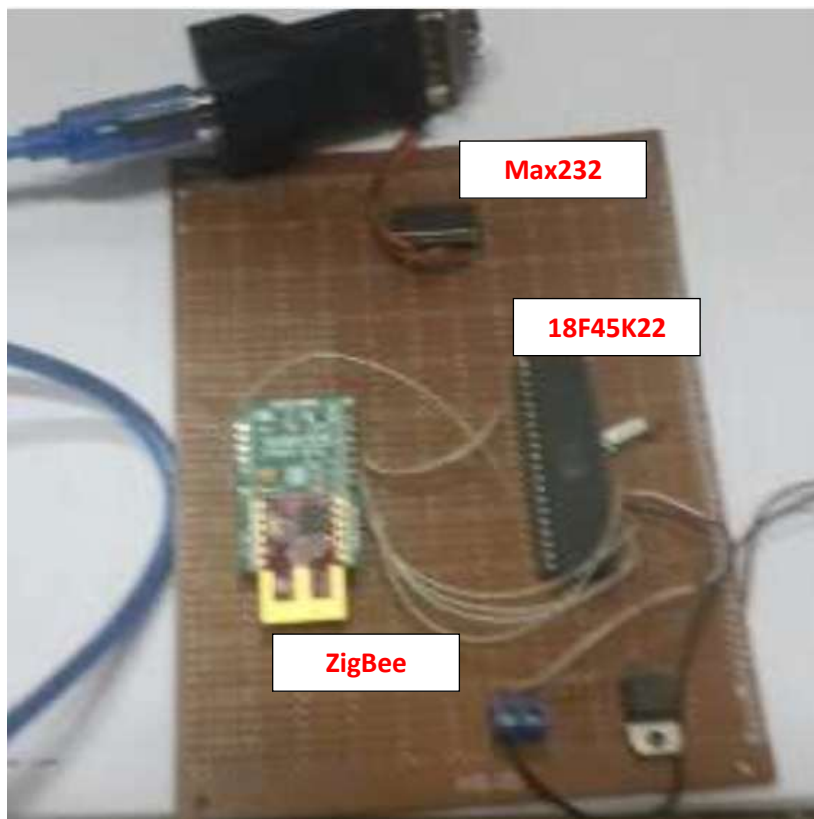

Figure (8) interface circuit design in Master Side

The software has been designed using Visual Basic 2012 as monitoring system to collected the data of each sensor and save these data to database

(Microsoft Office Access), in same time, the monitoring system display the changes of data with time as shown in figure (9) below.

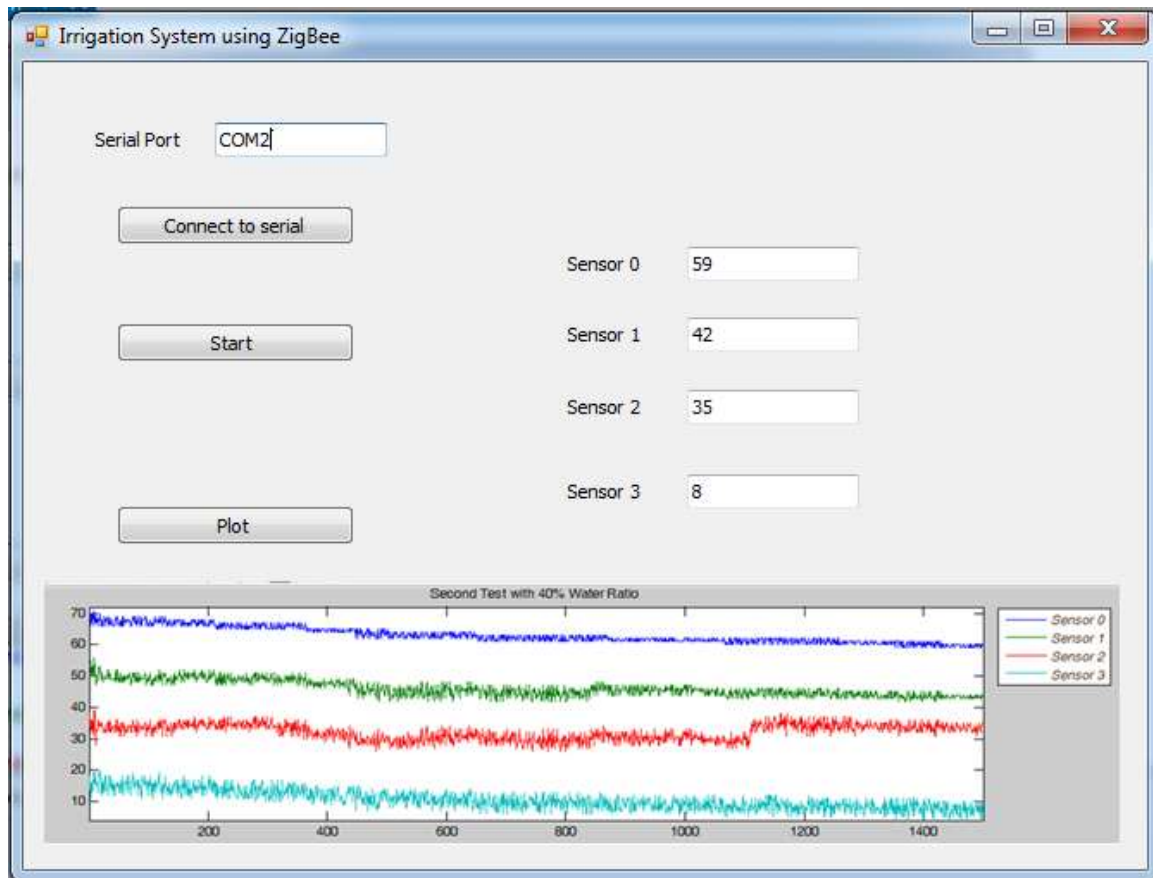

Figure (9) Monitoring System in Master Side

## 6. Results and discussion

The data of sensor in slave side (controller and sensors) will be sent data of sensing in-time to the master side (monitoring system) via ZigBee (node and coordinator), the master side has monitor to collect and display the data and interfaced via serial. An experimental result has taken during designing and testing of proposed design. There are taking different cases to test the status of the soil based on different ratios applying water, in addition to this, each sensor (four sensors) has tested different levels in each case of water ratio during (1500min) at 40-45c° room temperature in sunny day. There are two ratios has taken during the test (40 and 70% watered).

The monitoring system design was used a programming language (Visual Basic 2012) interfaced with master circuit via serial port, also, a database has been designed

using Microsoft Office Access (mdb), and this database contains a table (data) with three fields (sensor name, data collected, and time for each data). The visual basic application connected to this database to update and retrieve the data during application processing. These data will be plotted for each soil sensor and the whole data which took during two days. There is setting time among sensors during reading data and its set to 200 ms. There are two cases has taken in consideration during update the data, one with water ratio (40%) and other with water ratio (70%) and will be discussed in details below. for water ratio (40%), each moisture soil sensor is placed in different level horizontally in soil contained in a pot where the distance between these sensors is equally divided and the sensors(sensor no. 0,1,2,3) are placed from the bottom to the top respectively to test the ratio of soil drying during the time. Figure (9) shows each sensor data during (1500min) for water ratio (40%).

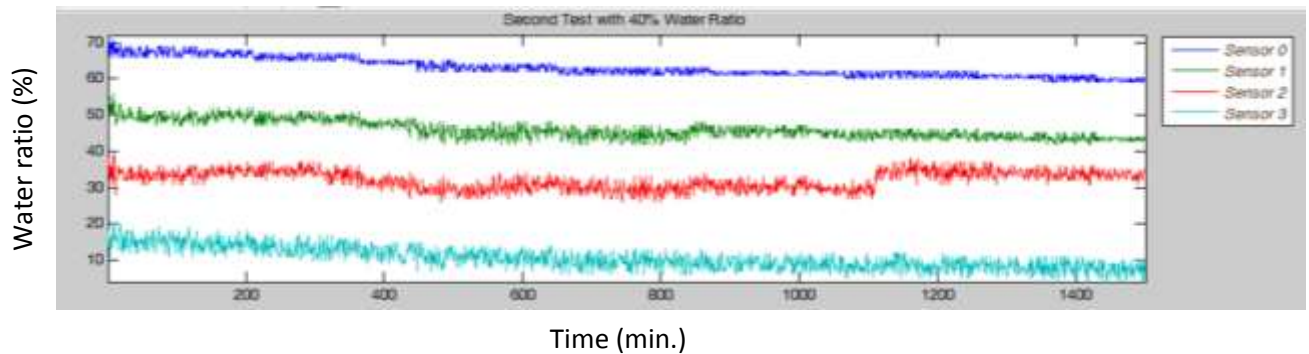

Fig. (9) Data plot for four sensors, soil dry with water (40%)

it is obvious from the graph that the sensor(0) has the maximum reading value and has the minimum dryness rate because it placed at the bottom of the pot where is saturated with water while sensor(3) has the minimum reading value and has the ability to dry earlier because it is placed at the top of the pot and near to the external surface

The soil sensor estimates the soil water and closely tracked the changes of the soil water over time. Over time, soil without continuously irrigated will become dry, and in this condition water will reduce within the soil and the measurement will give less value with time.

On the other hand, if the soil saturated with water, the measurements will give high values, and if watered will increase the value of soil moisture.

The sensors have been inserted in soil in different level horizontally to determine how soil moisture varies.

As notes from the above figure (9),the curve for each sensor data is nonlinearity, figures (10) show a linear estimator for nonlinear data of each sensor (0-3).linear estimator is used to create linear model and this model used to describe the relationship between a dependent variable (response)as a function of independent variables (predictors).

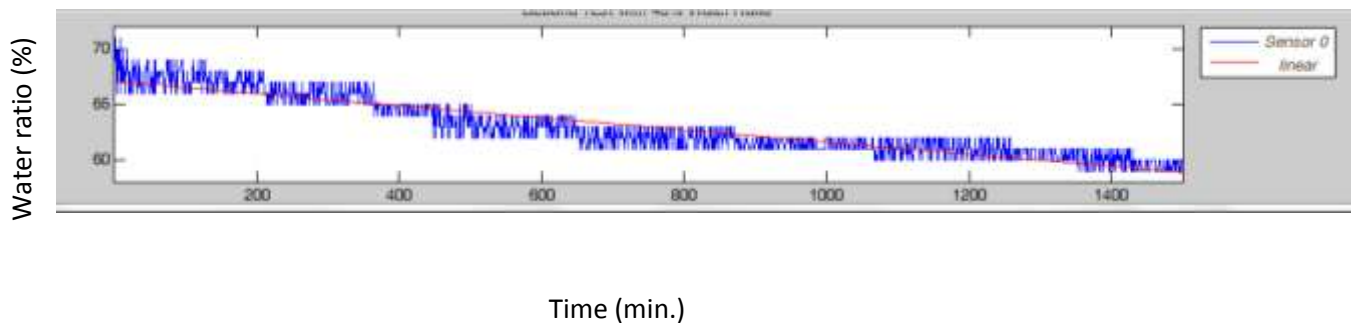

Fig. (10) plot sensor (0) with a linear estimator

A linear estimator has used for the actual values of the collected data as an approximate value of an unknown parameter of the sensing data.

For the same data, we've found STD (standard deviation). The result is the square root of an unbiased estimator of the variance of the reading from data sensor is drawn, as long as each data sensor consists of independent, identically distributed samples. The standard deviation calculates the spread of sensor readings .Figure (11) show STD of each data.

Water ratio (%)

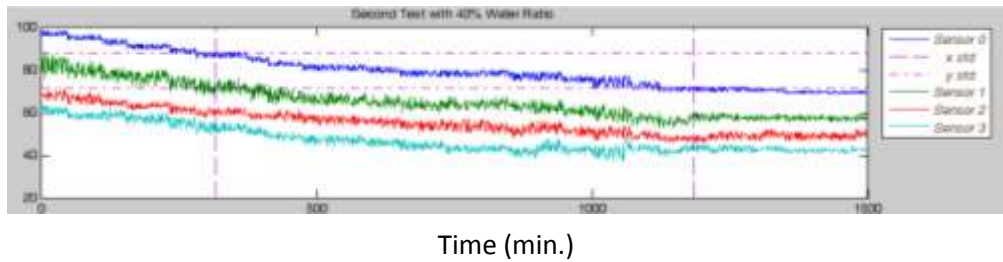

Fig. (11) STD along on data series of sensor (0)

In water ratio (70%), each moisture soil sensor has put in different level horizontally in soil to test the ratio of soil drying during the time. Figure (12) shows each sensor data during

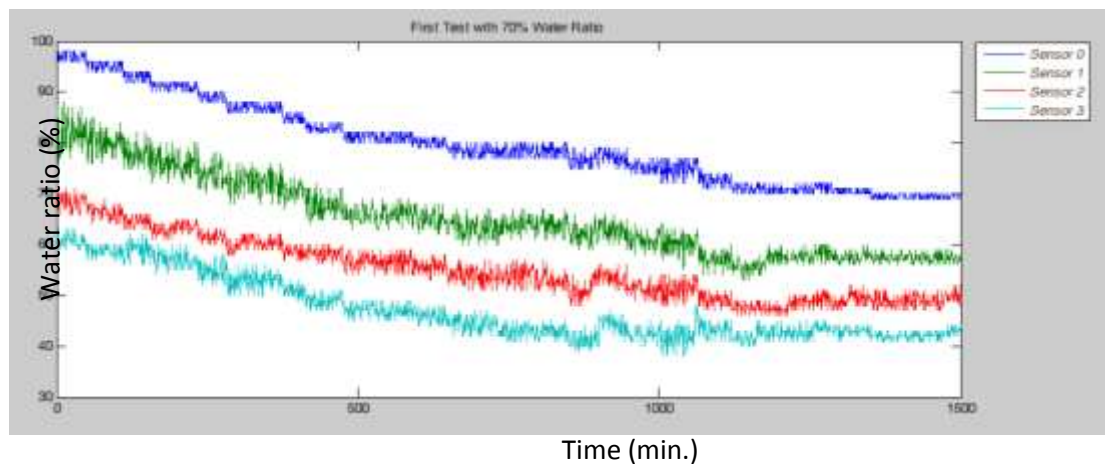

Fig.(12) Data plot for four sensors, soil dry with water (70%)

from the graph above, it is found that the all four sensors have high readings values and these values have slow dryness rate over the specified time because the high water ratio.

The notes from above figure, the curve each data is nonlinearity, figures (13) show a linear estimator for nonlinear data of each sensor (0-3).



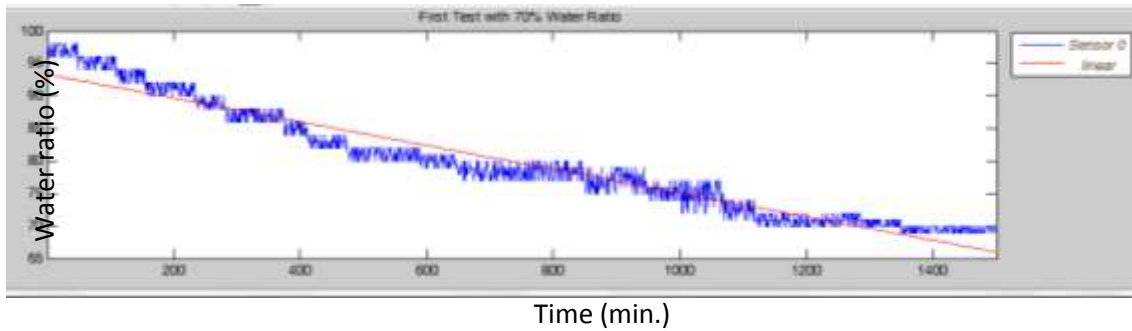

Fig. (13) plot sensor (0) with a linear estimator

For same data, we've found an STD (standard deviation). The result is the square root of an unbiased estimator of the variance of the readings from data sensor is drawn, as long as each data sensor consists of independent, identically distributed samples. Figures (14) show STD of each datum.

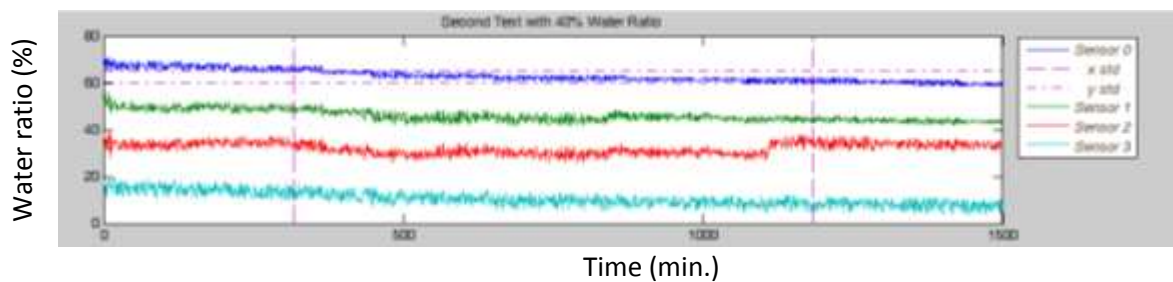

Fig. (14) STD along on data series of sensor (0)

## 6. Conclusion

The design and the implementation of soil moisture monitoring system using Zigbee as medium communication have been presented in this paper. The proposed design focused on wireless sensor nodes which represented in Zigbee modeler can greatly improve the reliability of installing the probes soil moisture sensor, the accuracy to measure water content in soil, and the efficiency of soil moisture monitoring . The monitoring in server side has abilities to present the data logs of each sensor; also, the data of soil moistures has been deliberate in a timely manner to changes in the soil properties.

## References

- 1- A.G. Smajstrla, F.S. Zazueta; "Lawn Sprinkler Selection and Layout for Uniform Water Application"; University of Florida (IFAS); 2005.
- 2- Yangzhou, China ; Jilin Cheng ; Xiaohong Jiang; "Study and application on optimization scheme of water distribution in gravity irrigation district of large-scale plain"; IEEE; 2010.
- 3- Jalil Jabari Lotf, Seyed Hossein Hosseini Nazhad Ghazani; "Overview on Wireless Sensor Networks"; Journal of Basic and Applied Scientific Research; J. Basic. Appl. Sci. Res., 1(12)2811 -2816, 2011.
- 4- Waltenequs Dargie and Christian Poellabauer, "Fundamentals of Wireless Sensor Networks: Theory and Practice", Wiley Series on Wireless Communications and Mobile computing, 2010.
- 5- Ahmed Zubair, "Design of Autonomous Low Power Sensor for Soil Moisture Measurement", thesis, Linköping University, 2013.
- 6- Z. Rasin, H. Hamzah and M. S. M. Aras of High Power Zigbee Based Wireless Sensor Network in Water Irrigation Control Monitoring System 2009 IEEE Symposium on Industrial Electronics and Applications (ISIEA 2009), PP. 548- 551, 2009.
- 7- A.N. Jyothipriya and T.P. Saravanabava, Controlled Solenoid Valve System for Drip Irrigation Research Journal, PP.1-9, 2013.
- 8- A. ur-Rehman, A. Z. Abbasi, N. Islam and Z. A. Shaikh wireless sensors and networks' applications in agriculture Standards & Interfaces, Vol.36, No.2, PP.263270, 2014.
- 9- Microchip, "PIC18 (L) F2X/4XK22 Data sheet", Microchip.