

Effect of Die's Shape, Sheet Thickness and Type of Alloy on the Springback Phenomenon

Bushra Rasheed Mohameed

Institute of Technology, Foundation of Technical Education / Baghdad

Ethar Mohamed Mhdi Mubarak

Institute of Technology, Foundation of Technical Education / Baghdad

Nawal H. Alsalihi

Institute of Technology, Foundation of Technical Education / Baghdad

Email: uot_magaz@yahoo.com

Received on: 13/10/2011 & Accepted on: 2/2/2012

ABSTRACT

In this paper the effect of the springback on the bending operation of different materials and alloys have been studied. Dies were designed and constructed in different shape (U-die , V-die) for several sheet's thickness. Two types of alloys were used; Aluminum Alloy 7020 T6 and Brass Alloy. These alloys have different sheet thickness (2, 4, 6 and 8) mm. Aluminum alloys are heated to 270 °C and 330°C with cooling in the furnace for 90 min. while the brass alloys heated to 300, 320, 340 and 420 °C with cooling for 2 hours in furnace. Bending was done by using the press of 80 ton. The springback is calculated by published equation. It can be concluded that, the springback phenomenon caused to enlarge the external dimensions when releasing the load and thick material have less springback due to the enlarge of the plastic deformation. It's found that the die's shapes have great effect on the springback, and when the temperature of the specimen is increased, caused decreased in the springback.

Keywords: Springback, forming process, aluminum alloy 7020, brass alloy, die design, bending die

تأثير شكل القالب ، سمك الصفیحة ونوع السبائك على ظاهرة الرجوعية

الخلاصة

في هذه الدراسة تمت دراسة تأثير الرجوعية (springback) على عملية الحني لمعادن مختلفة وهي : وسبيكة ألومنيوم Aluminum Alloy 7020 T6 وسبيكة البراص Brass Alloy .

وهذه السبائك ذات سمك مختلف (8mm, 6mm, 4mm, 2mm) اذ تم تصميم وتصنيع قالبين وهما : قالب حني على شكل مقطع V وقالب حني على شكل مقطع U .تم معاملته سبائك الالمنيوم معاملة حرارية بدرجة 270 و 330 درجة مئوية وتبريدها داخل الفرن لمدة 90 دقيقة . اما سبائك البراص فقد تم تسخينها الى 300 ، 320 ، 340 ، و 420 درجة مئوية وتم تبريدها بالفرن لمدة ساعتين . وقد بينت النتائج ان ظاهرة الرجوعية تسبب زيادة في الابعاد الخارجية بعد رفع الحمل وان المعادن السميكة لها رجوعية اقل بسبب التشوه اللدن . وايضا بينت

النتائج ان لشكل القالب وللمعاملة الحرارية تاثير كبير على مقدار الرجوعية في السبائك ، حيث ان كلما زادت درجة الحرارة قلت الرجوعية

INTRODUCTION

Springback can be defined as an elastically-driven change of shape of a deformed product which takes place during removal of external loads. It is a complex physical phenomenon which is mainly governed by the stress state obtained at the end of a deformation. Depending on the product geometry and deformation regime, there are several types of springback in sheet metal forming: bending, membrane, twisting and combined bending and membrane[1].

In this study bending springback can be observed after bending a material in plane strain [2]. Accurate modeling of springback in sheet metal forming requires that this phenomenon is well understood. Simple experimental procedures can be used to study the springback with various parameters, for example sheet thickness and die's shape [3]. Recent experimental investigations have shown that the springback phenomenon in sheet metals also involves small scale plasticity effects and is thus not fully elastic [4, 5]. Several methods are available for the prediction of springback. Analytical solutions that describe the change of product geometry after simple forming operations were developed, [6-8]. Springback analysis of complex industrial products is usually performed using the finite element (FE) method.

In recent years, various experimental techniques have been developed to study and characterizing the springback in sheet metals. The most popular and commonly used procedures are cylindrical bending[9], U-bending [10,11], V-bending [12–13] (Figure1) and flanging [3, 14]. These methods are attractive because the level of springback is large and can easily be measured. Sensitivity of springback to basic parameters, such as the tool radius to sheet thickness (R/t) ratio, mechanical properties of sheet material and contact parameters is usually studied. The major drawback of these experiments is that they cannot imitate realistic process conditions during sheet metal forming.

THEORETICAL CONSIDERATION

Because all materials have a finite modulus of elasticity, plastic deformation is followed by elastic recovery upon removal of the load; after the bending pressure on metal is released the bend angle decreases and the radius of curvature increases, because the elastic stresses in the metal are also released. The amount of metal movement, springback, depends primarily upon the ratio of the angles $\frac{\alpha_i}{\alpha_f}$ as in Figure 2,[15].

Springback factor [16] is expressed as $K = \frac{\alpha_i}{\alpha_f} = \frac{R_i+t/2}{R_f+t/2}$, a graphical method of determining the contour of form blocks to compensate for springback has been developed (Figure 3). The part is divided into a few lengths, L' , L'' , etc., each possessing an approximately common radius R' , R'' , R''' . These radii are determined graphically, and the ratios R/t (t = metal thickness) are found.

EXPERIMENTAL CONSIDERATION

Chemical Composition

The chemical composition of the received alloys compared with standard condition of 7020 AL- alloys are shown in Table 1.

The chemical composition analysis was carried out by using Arun Technology Metal Scan DeskTop Metals Analysis (2500 series – England 2004). This analysis was done in the Institute of Specialized Engineering.

Design and Manufacturing V-Die

V-die is designed under standard specification, Its consists of two parts, normally punch and die both are made from CK45.

1. No permit the partial punch and die hole forming, only the thickness of the metal in most cases.
2. Amount of dies lot (hole forming Die) have been taken from the table(3). [16]
3. Curvature of the top edge of the die is equal to the thickness of the metal at a minimum.
4. Head curvature and curvature of the end of the Punch-hole configuration according to die be required and most likely be $R_p \geq T$ arched head punch. $R_d = R_p + 1.25T$ curvature of the end of the hole forming die.

Four Punches and Dies are designed and manufactured to bend plate with thickness 2,4,6,8 mm

1- Die design

Figure (4), shows the V-die

2- Punch design

Figure (5), shows the punch

3- Assembly V-Die

The assembly V-die for thickness 2,4,6,8 mm as shown in Figure 6.

Design and Manufacturing U-Die

Figure 7, shows the important parts of the die-section -U-. The most important elements that must be considered when designing the forming die section U :

- (1) The difference between a slot-hole formation and presentation of die punch is the $2 \times$ (thickness of the sheet + allowable standard).
- (2) The need for apiece in the die-hole formation are moving strongly pressing the opposite amount of not less than 30% of work force composition required and called pressure pad or pad plate and has the benefit of reducing resilience and strength added to the configuration. Figure 8, shows the difference between the two dies once has pressure pad and the other does not contain them.

Four punches, dies, and ejectors are designed and manufactured to bend sheet with thickness 2,4,6 and 8 mm .

1- Punch design

Figure (9), shows the design of punching process, Table(4), explains the dimensions of the punch for U-Die

2- Die design

Figure (10), shows the dimension of the die .Table 5, explains the dimensions of the U-Die

3- Ejector design

Figure (11), shows the dimension of the ejector .Table 6, explains the dimensions of the U-Die

4- Assembly U-Die

Figure (12), shows the assembly of U-Die, Figure (13) shows the schematic diagram of the U-Die.

Press type

Press of 80 ton was used as shown in Figure (14)(Lab. of Technical College - Baghdad) .

Apparatus Assembly

After designing the U-die,V-die, they combined with the press as in Figure 15.

Standard Bending Specimens

Table (7) , demonstrates the standard dimensions of the V- bending specimen , and Table (8) , demonstrates the standard dimensions of the U- bending specimen.

Results and Discussion

Springback is very important factor to influence quality of sheet metal forming. Accurate prediction and controlling of springback is essential for the design of tools for sheet metal forming , many parameters affect on this phenomenon (die's shape, sheet thickness and type of alloy). The important parameter in this work is type of bending die that effect on springback and also two types of alloys are used in this study, Aluminum 7020 T-6 and Brass, the specimens are heated to temperature 270°C and 330 °C and cooling in furnace with 90 min. while in brass specimens to 300, 340, 380 and 420 °C then cooling slowly in furnace with 2 hours. Results are shown in Figures (16) to (18) which are explain the variation of the heat treatment on the springback with U and V dies and with different specimens thickness. Figure(16) shows the variation of the springback using V-Die and aluminum specimen with different heat treatment (270°C and 330 °C and cooling in furnace for 90 min.). Figure (17) shows the variation of the springback using V-Die and brass specimen with different heat treatment (300 , 340 , 380 and 420 °C and cooling slowly in furnace for 2 hours). Figure (18) shows the variation of the springback using U-Die and Aluminum specimen with different heat treatment (with 270°C and 330 °C and cooling in furnace with 90 min.). From these figures it can be seen that the heat treatment and the thickness of specimen and the type of metal , had an effect on the springback of the sheet.

CONCLUSIONS

- 1- The springback phenomenon causing an enlargement of the external dimensions when lifting the load.
- 2- The thick material have less springback due to an enlargement of the plastic deformation.
- 3- The die shape has a greater impact on springback , lower springback results with U- die shape and higher springback results with V-die.
- 4- It was found that when increasing the heat treatment of the specimen, causing of decreasing in the springback .

REFERENCES

- [1] Wang. C. "An industrial outlook for springback predictability, measurement reliability and compensation technology". In D.Y. Yang, S.I. Oh, H. Huh, and Y.H. Kim, editors, Proceedings of the 5th International Conference and Workshop on Numerical Simulation of 3D Sheet Forming Processes ,NUMISHEET 2002, pages 597–604, Jeju Island, Korea, 2002.
- [2] Atzema, E.H. H. Kappert, A.W.A. Konter, S.E. Meijers, and T. Meinders. "Sensitivity analysis component 2: Scaled down car roof". Netherlands Institute for Metals Research, 2005.
- [3] Livatyali, H. and T. Altan. "Prediction and elimination of springback in straight flanging using computer aided design methods": Part 1. Experimental investigations. Journal of Materials Processing Technology, 117(1-2):262–268, 2001.
- [4] Cleveland , R.M. and A.K. Ghosh. "Inelastic effects on springback in metals". International Journal of Plasticity, 18(5-6):769–785, 2002.
- [5] Teodosiu, C. "Some basic aspect of the constitutive modelling in sheet metal forming". In D. Banabic, editor, Proceedings of the 8th ESAFORM conference on material forming, volume 1, pages 239–243, Cluj-Napoca, Romania, 2005.
- [6] Leu, D.K. "A simplified approach for evaluating bendability and springback in plastic bending of anisotropic sheet metals". Journal of Materials Processing Technology, 66(1-3):9–17, 1997.
- [7] Pourboghra, F. and E. Chu. "Springback in plane strain stretch/draw sheet forming". International Journal of Mechanical Sciences, 37(3):327, 1995.
- [8] Xue, P. T.X. Yu, and E. Chu. "Theoretical prediction of the springback of metal sheets after a double-curvature forming operation". Journal of Materials Processing Technology, 89-90:65–71, 1999.
- [9] Yang, D.-Y. S.I. Oh, H. Huh, and Y.H. Kim, editors. Proceedings of the 5th international conference and workshop "on numerical simulation of 3D sheet metal forming processes", NUMISHEET 2002, Jeju Island, Korea, 2002.
- [10] Chou, I.N. and C. Hung. "Finite element analysis and optimization on springback reduction". International Journal of Machine Tools & Manufacture, 39(3):517–536, 1999.
- [11] Han, S.S. and K.C. Park. "An investigation of the factors influencing springback by empirical and simulative techniques". In Proceedings of the 4th

International Conference and Workshop on Numerical Simulation of 3D Sheet Forming Processes, NUMISHEET 1999, pages 53–58, Besancon, France, 1999.

[12] Tekiner, Z. “An experimental study on the examination of springback of sheet metals with several thicknesses and properties in bending dies”. *Journal of Materials Processing Technology*, 145(1):109–117, 2004.

[13] Zhang, L.C. G. Lu, and S.C. Leong. “V-shaped sheet forming by deformable punches”. *Journal of Materials Processing Technology*, 63(1-3):134–139, 1997.

[14] Livatyali, H. H.C.Wu, and T. Altan. “Prediction and elimination of springback in straight flanging using computer-aided design methods”: Part 2: Fem predictions and tool design. *Journal of Materials Processing Technology*, 120(1-3):348–354, 2002.

[15] Cao, J. “Consistent and minimal springback using a stepped binder forcetrajectory and neural network control”. *Journal of Engineering Materials andTechnology*, Transactions of the ASME, 122:113 – 118, 2000.

[16] Die Design Handbook

[17] Mat web, the on line materials Database, “Aluminum 7020 , 7000 series Aluminum Alloy , Aluminum Association, 2007.

[18] Pijlman, H. “Sheet material characterisation by multi-axial experiments”. PhD thesis, University of Twente, 2001.

[19] Carden, W.D. L.M. Geng, D.K. Matlock, and R.H. Wagoner. “Measurement of springback”. *International Journal of Mechanical Sciences*, 44(1):79–101, 2002.

Table (1) the Chemical Composition of 7020 Alloy

Elements	Standard value [17]	Measured value
Si	< = 0.35	0.121
Fe	< = 0.40	0.290
Cu	< = 0.20	0.200
Mn	0.05 - 0.5	0.0764
Mg	1 -1.5	1.25
Cr	0.10 – 0.35	0.228
Zn	4 – 5	4.56
Ti	0.08	0.0319
Al	BALANCE	BALANCE

Table (2) Chemical compositions of copper bars

Zn%	Pb%	Sn%	P%	Mn%	Fe%	Ni%	Si%	Al%	S%
0.01	0.02	0.01	0.007	0.002	0.005	0.02	0.006	0.014	0.003
Ag%	Co%	Cu%							
0.005	0.01	99.5							

Table (3) shows the width's die relative to the thickness of the sheet [18,19]

Thickness	Die Width = W
$T \leq 0.05$ mm	$W = 20 * T$ (mm)
$0.5 \leq T \leq 1$ mm	$W = 16 * T$ (mm)
$1 < T \leq 3$ mm	$W = 12 * T$ (mm)
$3 < T \leq 5$ mm	$W = 10 * T$ (mm)
$T > 5$ mm	$W = 8 * T$ (mm)

Table (4) Dimensions of the punch

NAM E PART	WORK SHOP	Dimensio ns (mm)	WORK SHOP	Dimensio ns (mm)	
PUNCH 1	CUTTIN G	105X65X25	MILLIN G	100X60X20	2
PUNCH 2	CUTTIN G	105X65X37	MILLIN G	100X60X32	4
PUNCH 3	CUTTIN G	105X65X41	MILLIN G	100X60X36	6, 8

Table (5) Dimensions of the die

PART NAME	WORCK SHOP	DIAMENSIO N	WORCH SHOP	DIAMENSIO N
DIE 1	CUTTIN G	85X65X53	MILLIN G	80X60X48
DIE 2	CUTTIN G	85X65X45	MILLIN G	80X60X40
DIE 3	CUTTIN G	85X65X41	MILLIN G	80X60X36

Table (6) Dimensions of the Ejector

part name	work shop	Dimension	work shop	dimension	t
ejector	cutting	65X30X28	MILLING	60X25X23	2
ejector	cutting	65X30X44	MILLING	60X25X39	4
ejector	cutting	65X30X52	MILLING	60X25X47	6, 8

Table (7) V- Die specimen

Thickness (mm)	Width (mm)	Length (mm)
2	50	150
4	50	150
6	50	150
8	50	150

Table (8) U- Die specimen

Thickness (mm)	Width (mm)	Length (mm)
2	50	150
4	50	150
6	50	150
8	50	150

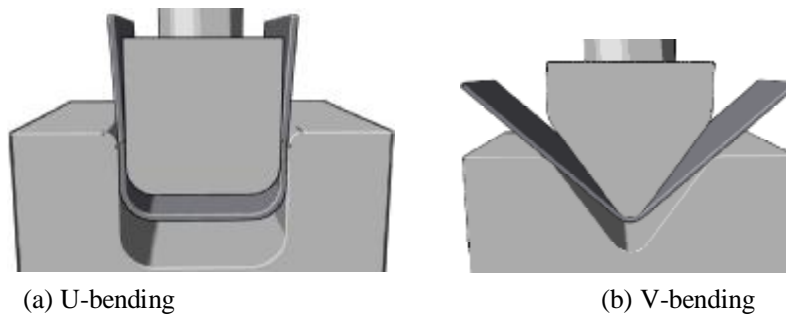

Figure (1) V-die and U-die processes

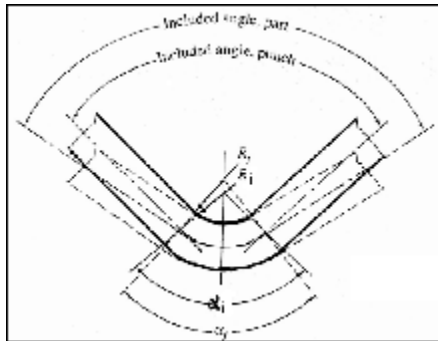

Figure (2) explain the springback Phenomena

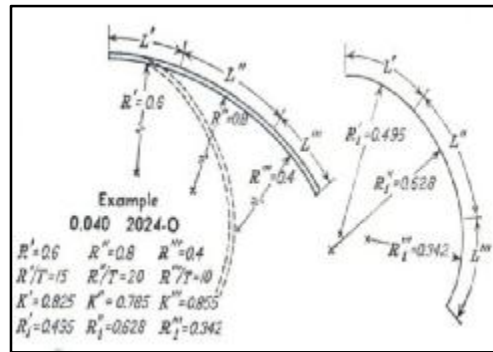
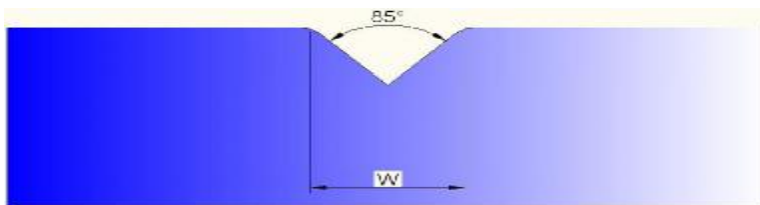

Figure (3) Graphical method determining form- block contours



- a -



- b -

Figure (4) V-die (a) drawing (b) photos for several sheet's thickness

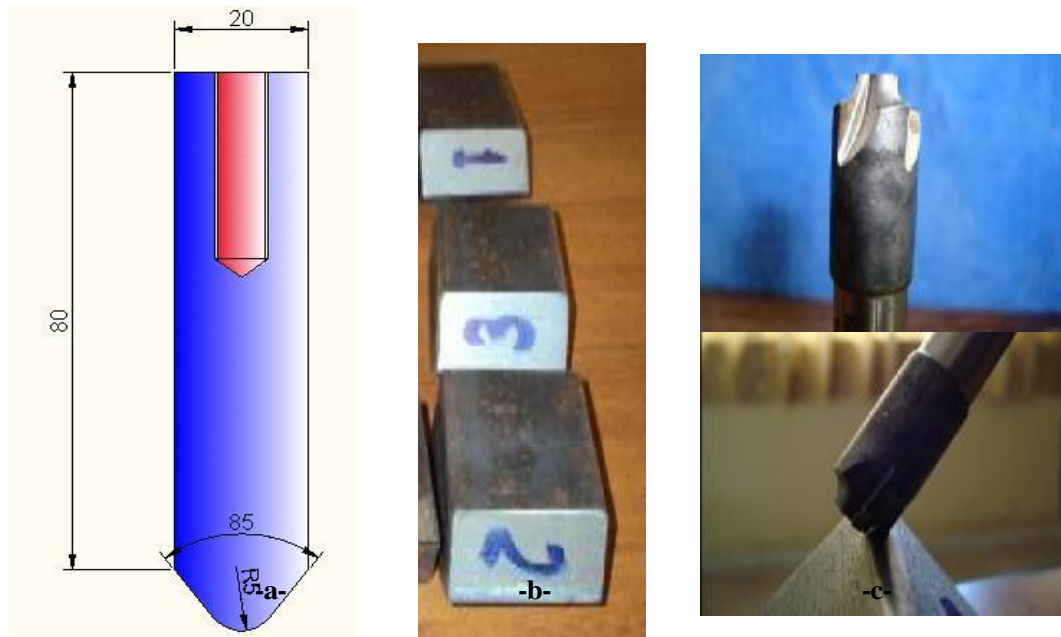

Figure (5) Punching of V-die (a) drawing (b) photos for several sheet's thickness (c) tool was used to get the tip of radius = 5mm

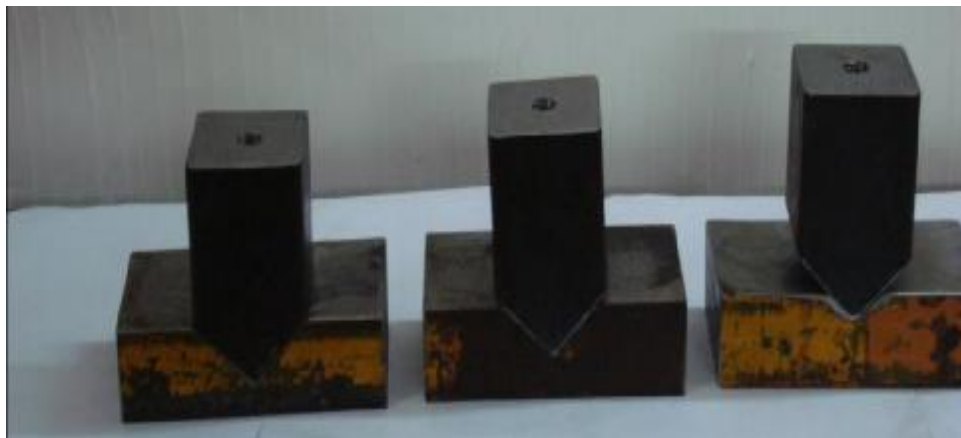

Figure (6) the assembly of V-die for thickness 2,4,6,8 mm

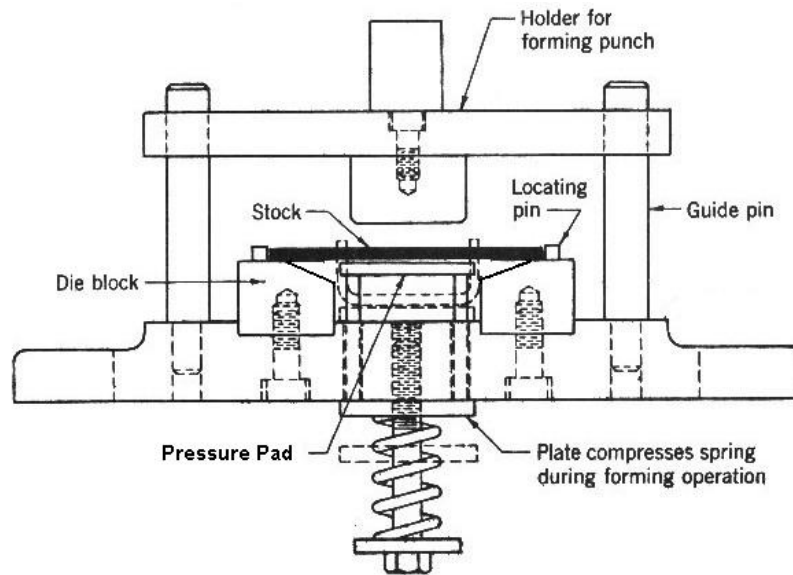

Figure (7) U-Die

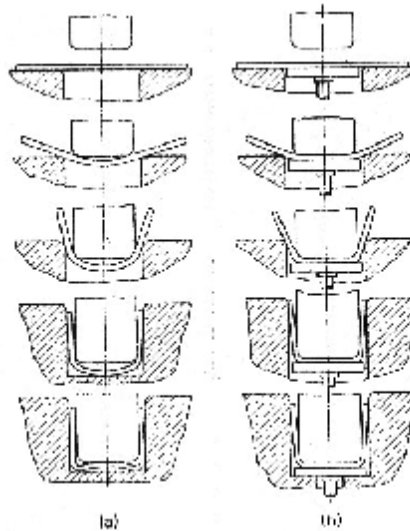
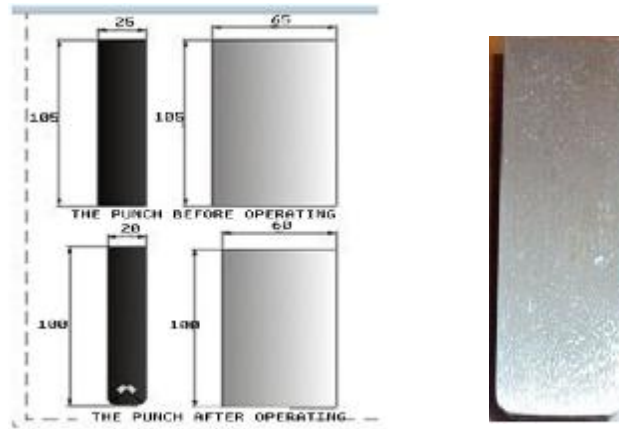

Figure (8) the stages of bending for die (a) U without section Pad Plate (b) U contains a section Pad Plate.



-a-

-b-

Figure (9) Punching of U-die processes (a) drawings (b) photo

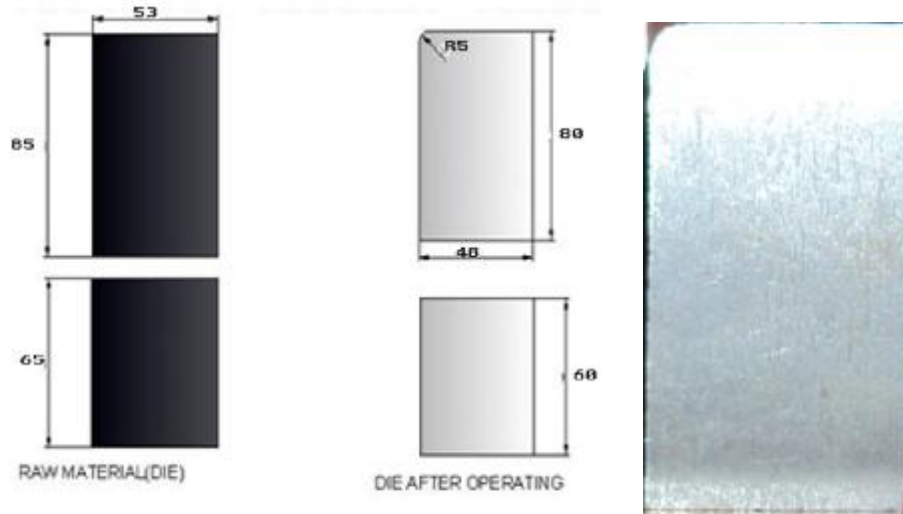

-a-

-b-

Figure (10) Die's dimension (a) drawing (b) photo

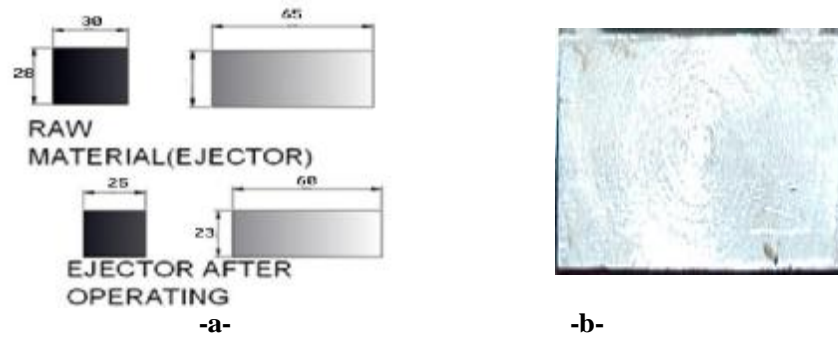

Figure (11) Ejector (a) drawing (b) photo

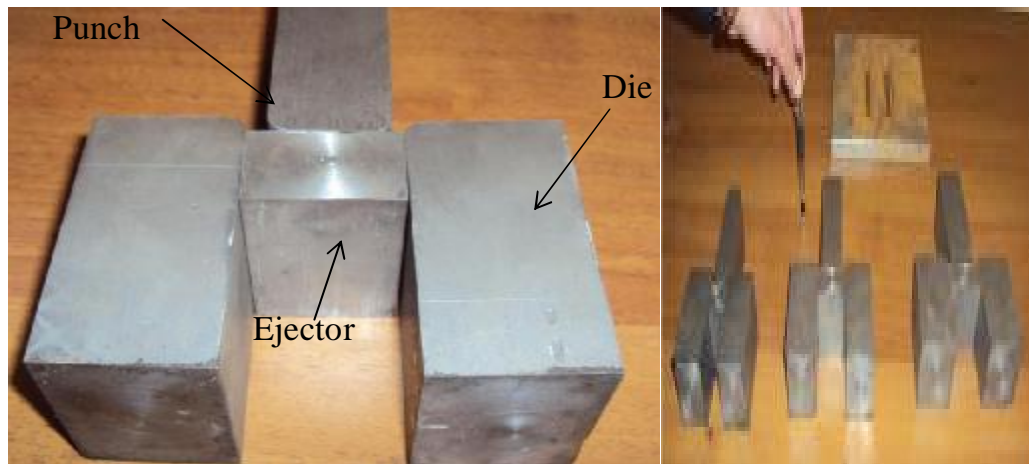
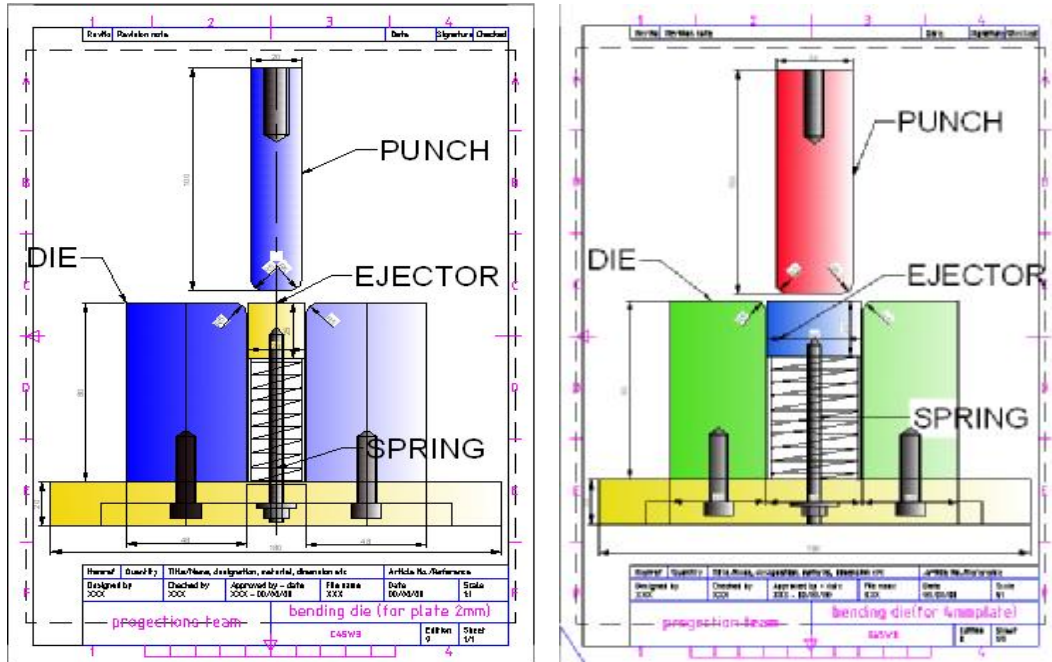
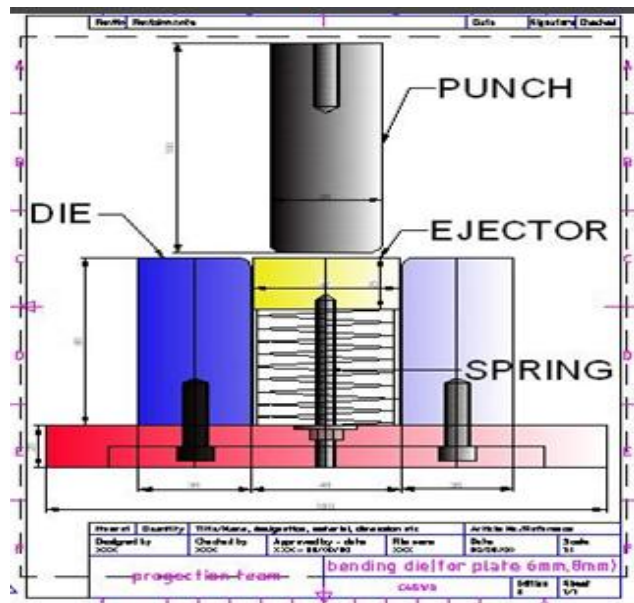

Figure (12) the assembly of U-Die



(a) For Thickness = 2 mm

(b) For Thickness = 4 mm



(c) For Thickness = 6 and 8 mm

Figure (13) the schematic diagram of the U-Die



Figure (14) Press process



Figure (15) Assembly of V-die

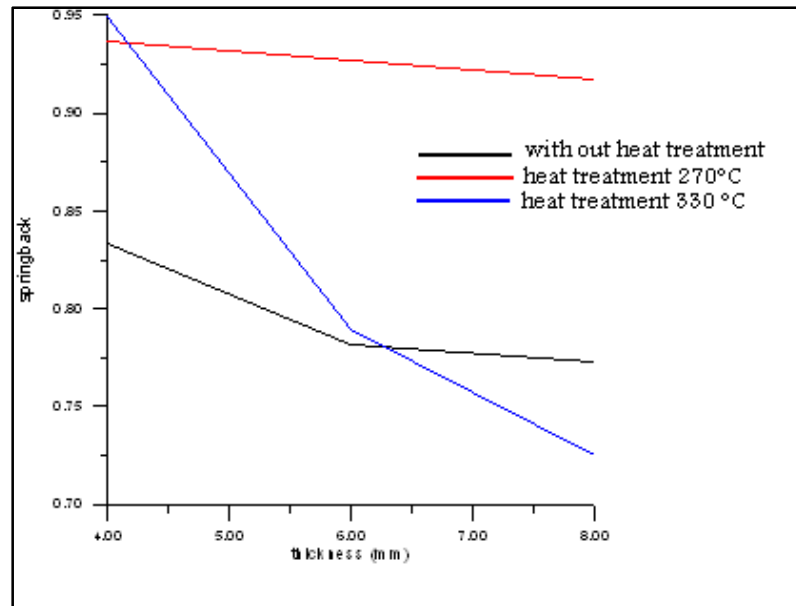

Figure (16) shows the variation of the springback using V-Die and Aluminum specimen with different heat treatment (with 270°C and 330 °C and cooling in furnace with 90 min.)

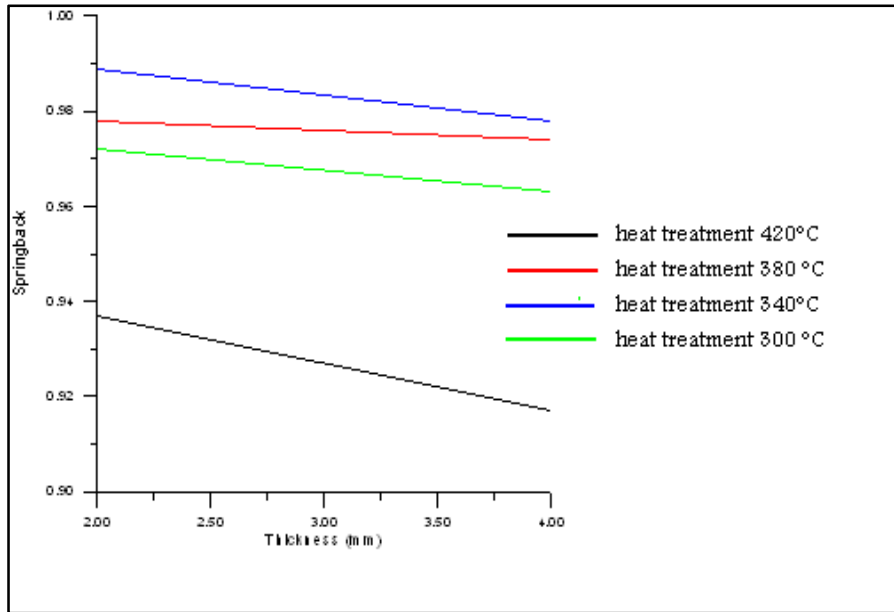

Figure (17) shows the variation of the springback using V-Die and Brass specimen with different heat treatment (300 , 340 , 380 and 420 °C and cooling in furnace with 2 hours).

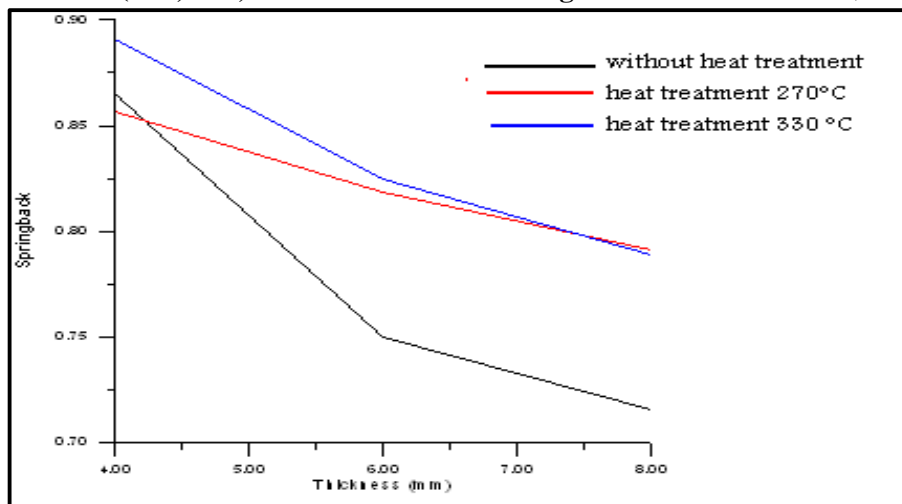

Figure (18) shows the variation of the springback using U-Die and Aluminum specimen with different heat treatment (with 270°C and 330 °C and cooling in furnace with 90 min.)