

## Sub-Cooling Auxiliary System for Performance Enhancement of Main Refrigeration System

**Dr. Ahmed J. Hamad**

Engineering Technical College, foundation of technical education/Baghdad

Email: ahmed.elhamad@yahoo.com

**Dr. Fawziea M. Hussien**

Engineering Technical College, foundation of technical education/Baghdad

Email: Fawizea\_material@yahoo.com

**Mustafa W. Hamadalla**

Engineering Technical College, foundation of technical education/Baghdad

Email: mustafawadd\_82@yahoo.com

Received on:24/3/2014 & Accepted on:9/7/2015

### Abstract

In present work, a sub-cooling auxiliary system is integrated with vapour compression refrigeration system to predict the performance characteristics and energy saving of the system. An experimental investigation was performed to determine the performance parameters at various operating conditions using two types of refrigerants, R-134a and zeotropic mixed refrigerant R-404A. Investigating the results has showed that, the enhancement in performance of the refrigeration system with sub-cooling circuit compared with that for system without sub-cooling for R-134a was about 5% increase in RE, 14% optimization in COP and 2.8% energy saving for different thermal loads applied on the evaporator. While for R-404A, the increase in RE was 4%, the optimization in COP was about 13% and 3.7% energy saving. There is a significant improvement in the performance of the system with R-404A compared with that for R-134a at the same operating conditions.

**Keywords:** Sub-cooling, Energy saving, R-134a, R-404A, Refrigeration

استخدام منظومة تبريد مفرط ثانويه لتحسين اداء منظومات التبريد الرئيسية

### الخلاصة:

تتضمن الدراسة الحالية استخدام منظومة تبريد انضغاطية ملحقة بها منظومة تبريد مفرط ثانويه لدراسة خصائص الاداء ومقدار التوفير بالطاقة للمنظومة. تم اجراء استقصاء تجريبي لحساب برامترات الاداء في ظروف تشغيل مختلفة باستخدام نوعين من وسائط التبريد, R-134a ووسيط مختلط زيوتروبي R-404A عندما تشغل المنظومة بدون ومع دورة تبريد مفرط ثانويه. تحليل النتائج قد أوضح بان مقدار زيادة الاداء للمنظومة مع دورة التبريد الثانويه كان بزيادة 5% في سعة التبريد

و 14% زيادة في معامل الاداء ومقدار التوفير بالطاقة 2.8% لوسيط التبريد R-134a عند احمال حرارية مختلفه, بينما للوسيط R-404A كانت حدود 4% و 13% و 3.7% على التوالي. لوحظ وجود تحسن ملموس في اداء المنظومة عندما تعمل بوسيط التبريد R-404A مقارنة بالوسيط R-134a عند ظروف تشغيل متشابهة.

### Nomenclature:

$C_p$	Specific heat at constant pressure (kJ/kg.°C)
$h$	Specific enthalpy (kJ/kg)
$\dot{m}$	Refrigerant mass flow rate (kg/ s)
$P$	Pressure (kPa)
$\dot{Q}$	Rate of heat transfer (kW)
$T$	Temperature (°C)
$W$	Work of compressor (kW)
$\varepsilon$	Heat exchanger effectiveness

### Subscripts

a	air
c	condenser
ev	evaporator
in	entering
m	main cycle
r	refrigerant
s	sub-cooling
w	water

### Abbreviations

COP	Coefficient of performance
MSC	Mechanical sub-cooling circuit
RE	Refrigeration effect (kJ/kg)
VCR	Vapour compression refrigeration

## INTRODUCTION

The large amount of the electrical energy generated in the world, is consumed by vapor-compression refrigeration and air-conditioning systems used in large buildings, supermarkets, cold storage, etc. In a super market, refrigeration systems consume a large amount of energy in maintaining chilled and frozen food, meanwhile, heating, ventilating, and air-conditioning system is used to assure thermal comfort for occupants and suitable climatic conditions for refrigerated cases [1]. The large temperature differences between the condenser and the evaporator imply greater compressor-power consumption and less refrigeration effect per unit of refrigerant. This may cause the compressor of the refrigeration or an air-conditioning system to operate for prolonged periods under extreme weather conditions in order to meet the desired refrigeration and cooling demand, which may be harmful to the system, and require a large amount of the generated electrical power.[2],[3]

Energy consumed by refrigeration systems used in large building and supermarkets can be saved by using one or more methods of performance enhancement for refrigeration systems such as using, sub-cooling , heat exchangers, mixed refrigerants, etc.. An integrated mechanical sub-cooling loop has been incorporated to vapor compression refrigeration system with different refrigerants in current work to improve the system performance and reduce the electrical energy consumption. Performance of the vapor compression refrigeration system can be improved and the energy can be saved by

improving the efficiency of system individual components, compressors, condensers, fans, etc... Advances in component technology, such as the electronic controllable expansion valves and variable speed control of compressors and fans, makes it possible to implement more advanced control schemes that achieve a better performance and furthermore a better energy efficiency [4]. Performance enhancement methods for VCR system, such as using sub-cooling cycle is used as well to improve the performance and reduce the overall power consumption of the refrigeration systems.

Many research works have considered the method of using sub-cooling cycles to improve the refrigeration system efficiency, Bilal and Zubair [2], [3] investigated the efficiency of the vapor compression refrigeration system with integrated and dedicated mechanical sub-cooling cycles using a set of refrigerants, and they found that, the second law efficiency of the cycle increased by an average of 21%, and the COP and refrigeration effect of the system was improved. Ming-Jer [5] investigated the enhancement of thermal performance for an air conditioning system utilizing a cold storage unit as a subcooler. Two operation modes, subcooled mode with energy storage and non-subcooled mode without energy storage were tested, the results showed that, the cooling capacity and COP for subcooled mode are greater in range 14% - 16% comparing with non-subcooled mode. Torrella [6] presented an experimental evaluation for two-stage vapor compression facility with direct liquid injection and two-stage with sub-cooler using the refrigerant R404A. The analysis of the results showed that, The configuration yielding the best results was the two-stage compression cycle with sub-cooler, since the cooling capacity and COP values for this configuration were the highest from an energy point of view. Laeun [7] investigated the effects of the sub-cooling heat exchanger (SCHX) on the performance of the multi-split variable refrigerant flow (VRF) system with long pipe in a field test during the cooling season. It was found that VRF system with SCHX improved the cooling performance factor (CPF) about 8.5% under similar outdoor temperature profiles, as compared to the baseline without SCHX. Khan [8] developed thermodynamic models of the dedicated mechanical sub-cooling systems to simulate the actual performance of the system, particularly with respect to the sub-cooler saturation temperature in addition to the heat exchanger areas. It is demonstrated that the performance of the overall cycle is improved over the corresponding simple cycle and this improvement is found to be related to the refrigerant saturation temperature of the sub-cooler.

In the present study, it is focused on using of integrated sub-cooling auxiliary system as one of the methods used for performance enhancement of VCR system. A set of experimental tests are conducted on test rig developed in the present work to investigate the performance parameters of the VCR system with and without sub-cooling using pure refrigerant R-134a and zeotropic refrigerant R-404A.

### **Cycle Description and Analysis**

The performance of a simple vapor compression refrigeration system can be significantly improved by further cooling the liquid refrigerant, leaving the condenser coil. This sub cooling of the liquid refrigerant can be accomplished by adding a mechanical sub-cooling loop in a conventional vapor compression cycle. The sub cooling system can be either a dedicated mechanical-sub cooling system or an integrated mechanical-sub cooling system [9]. In a dedicated mechanical-sub cooling system there are two condensers, one for the main cycle and one for the sub cooler cycle, whereas for an integrated mechanical-sub cooling system there is only one condenser serving both the main cycle and the sub cooler cycle as shown in figures(1) and (2) [10],[11].

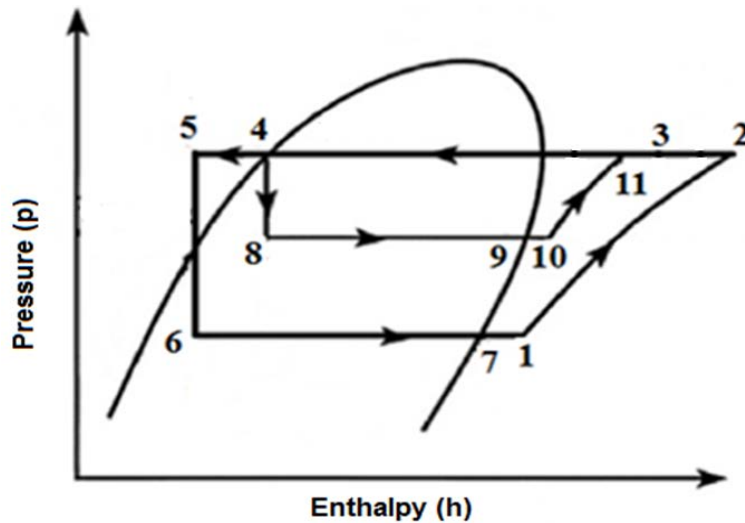
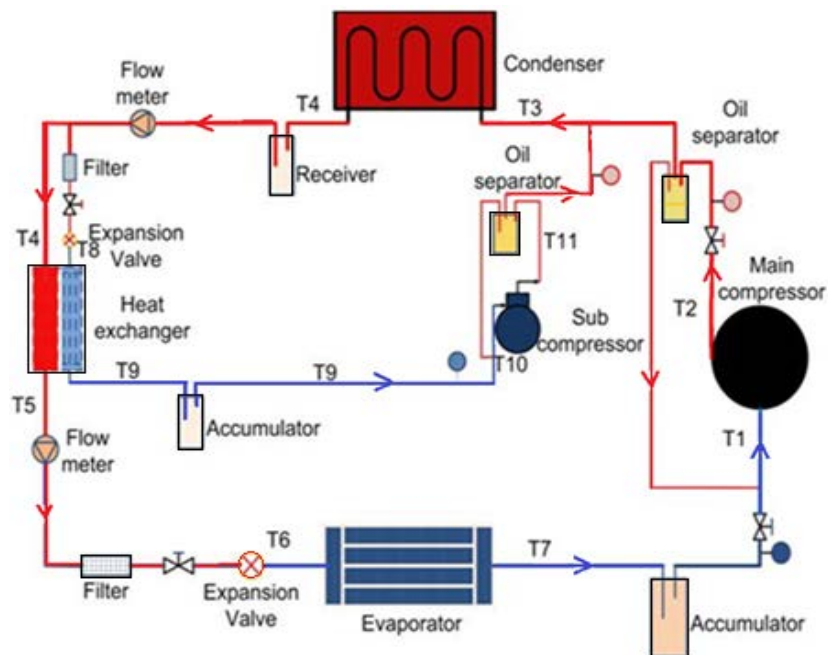

Figure (1) Pressure and Enthalpy diagram of refrigeration cycle with sub-cooling



Figure(2) Vapor compression refrigeration system with mechanical sub-cooling cycle.

Sub cooling of the refrigerant at the exit of the condenser in a vapor compression refrigeration system allows the refrigerant to enter the main cycle evaporator with a lower quality and thus allows the refrigerant to absorb more heat in the evaporator, thereby improving the coefficient of performance (COP) of the system. The work input to the main cycle compressor can be determined by: [2][12]

$$W_m = \dot{m}_m (h_2 - h_1) \quad \dots (1)$$

The work input to the sub-cooling circuit compressor can be expressed by:

$$W_s = \dot{m}_s (h_{11} - h_{10}) \quad \dots (2)$$

The heat transfer rate at the condenser can be calculated using the following equation:

$$\dot{Q}_c = \dot{m} (h_3 - h_4) \quad \dots (3)$$

Where:  $\dot{m} = \dot{m}_m + \dot{m}_s$  ... (4)

The heat transfer rate in the evaporator can be calculated by:

$$\dot{Q}_{ev} = \dot{m}_m (h_7 - h_6) \quad \dots (5)$$

At sub-cooler heat exchanger, the rate of heat transfer between the refrigerant flowing through the sub-cooling circuit and the refrigerant coming from the condenser can be expressed as [2]:

$$\dot{Q}_s = \varepsilon \dot{Q}_{max} = \dot{m}_m C_{p_r} \varepsilon (T_4 - T_8) \quad \dots (6)$$

Where

:  $C_{p_r}$  represents the specific heat of the refrigerant that was calculated as the average of the values at state 4 and state 5.

Considering the energy balance on the sub-cooler heat exchanger, the following equation can be written:

$$\dot{m}_m (h_4 - h_5) = \dot{m}_s (h_9 - h_8) \quad \dots (7)$$

The COP of the refrigeration system can be expressed as:

$$COP = \frac{\dot{Q}_{ev}}{w_m + w_s} \quad \dots (8)$$

The refrigeration effect RE of the system can be determined by:

$$RE = (h_7 - h_6) \quad \dots (9)$$

The thermal loads of air and water placed in the freezing compartment of the refrigeration system are named as, base line load, load I and load II which are listed in Table (1) and calculated as follow:

The thermal load  $Q_w$  in (kJ) of the water placed in the freezing compartment of the refrigeration system was calculated by:

$$Q_w = m_w C_{p_w} (\Delta T_w) \quad \dots (10)$$

Where:

$m_w$  = mass of water placed in the freezing compartment.

$\Delta T_w$  = the difference in temperatures of water at the beginning and end of the system operation period.

Base line load represents the thermal load of the evaporator when the freezing compartment is empty (contains only air) and can be expressed as:

$$Q_a = m_a C_{p_a} (\Delta T_a) \quad \dots (11)$$

Where:

$m_a$  = mass of air occupied in the freezing compartment.

$\Delta T_a$  = the difference in temperatures of air at the beginning and end of the system operation period.

Loads I and II represent the total thermal load (Q) of the air and different quantities of water placed in the freezing compartment of the system which are expressed by:

$$Q = Q_a + Q_w \quad \dots (12)$$

**Table (1) Thermal loads applied in the freezing compartment.**

	Thermal load in the freezing compartment	Q (kJ)
<b>Base line load</b>	Air (at 50 °C )	165
<b>Load I</b>	Air (at 35 °C) and water (49 kg at 35 °C)	8949
<b>Load II</b>	Air (at 50 °C) and water (49 kg at 50 °C)	12279

**Experimental Method**

Vapor compression refrigeration system of 3 ton capacity with integrated mechanical sub-cooling auxiliary system is built in current work with the possibility of conducting a set of experiments to investigate the performance of the system and electrical energy consumption in two cases, first case without sub-cooling cycle and the second with sub-cooling cycle integrated in the system. The experimental test rig consists of, one scroll compressor of model (ZR36K1-PFJ-501) with power 2700W for main refrigeration system, one reciprocating compressor model (E1120CZA AC) with power 264W for sub-cooling auxiliary system, one air cooled condenser, one evaporator, one sub-cooler heat exchanger (shell and tube), two thermostatic expansion valves, flowmeters, freezing compartment with dimension of (1.6m\*0.9m\*1.9m), oil separators, accumulators, pressure gauges and other accessories of the refrigeration system as shown in figure(3). The test refrigeration system is at first air evacuated and checked for leakage and then charged with a single refrigerant R-134a, the sub-cooling cycle is turned off and the main cycle is turned on in the test system, the system is then operated without thermal load in the freezing chamber for 15 min. to ensure proper operation. The readings are taken every 5 min. at different measuring points for test system including, many sets of, temperature readings, suction and discharge pressures, refrigerant mass flow rate and electrical power consumed during test period. Three values of thermal loads are applied in the freezing chamber and the readings of measuring points at test system are taken. Both sub-cooling cycle and main cycle are turned on in the test system, and the above steps are repeated. The test refrigeration system is then charged with the refrigerant R-404A and the same steps for R-134a are repeated.

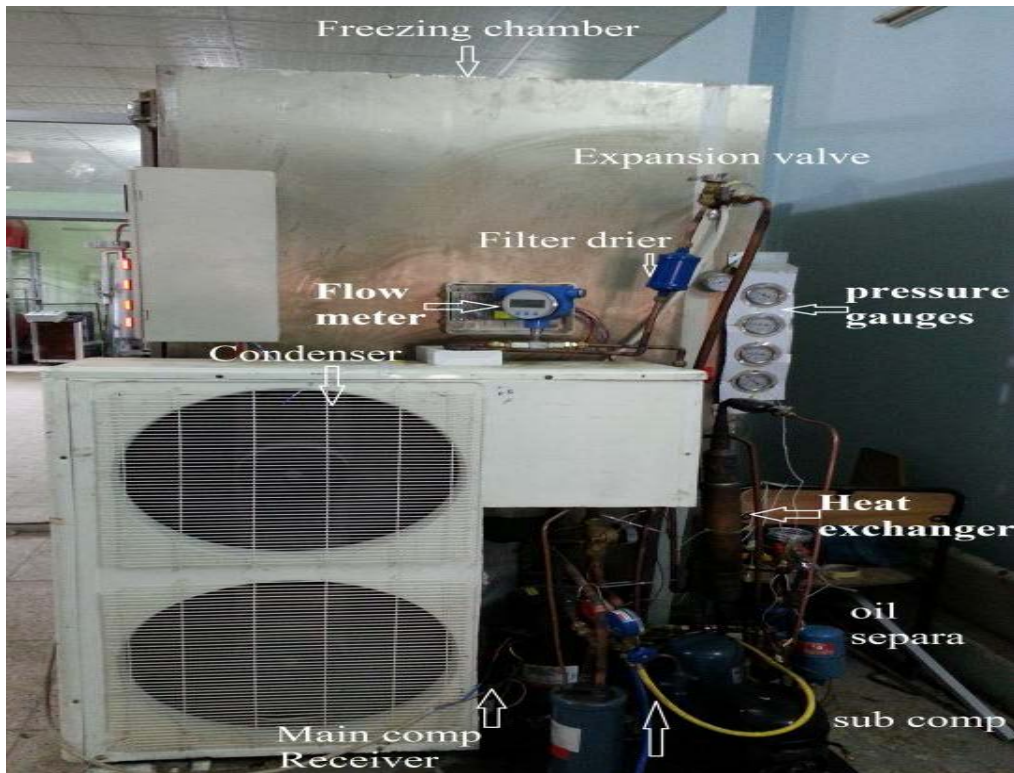

Figure (3) Experimental test rig.

### Results and Discussion

The performance parameters of the refrigeration system with and without sub-cooling cycle are investigated in this section for refrigerant R-134a and zeotropic mixed refrigerant R-404A at different operating conditions and three thermal loads applied in the freezing compartment of the test rig system, base line load (165 kJ), load I (8949 kJ) and load II (12279 kJ) as illustrated in Table (1). Numerical and experimental results are evaluated depending on many cycle parameters such as, temperature, pressure, mass flow rate and power consumed by compressors measured at different reading points in the test rig of refrigeration system. The variation of COP with operating time for the system with sub cooling and refrigerant R-134a is shown in Figure 4. It can be observed in this figure that, the higher value of COP was for load II compared with other thermal loads due to the fact that the increase in the thermal load applied in the freezing compartment will result in a higher value for the refrigeration effect relative to the work of compressors which in turn leads to increase the value of COP based on the definition of coefficient of performance. Figure 5 shows the variation of the evaporator inlet temperature with operating time for the system with sub cooling and refrigerant R-134a. It can be seen from this figure that, the evaporator inlet temperature decreases progressively with time where the lower value was for less load (base line load) due to the effect of thermal loads in the freezing compartment which reflects a normal behavior of system operation with sub-cooling effect. Through 60 minutes of system operation, the evaporator inlet temperature at loads, base line, I and II approached approximately  $-14^{\circ}\text{C}$ ,  $-7^{\circ}\text{C}$ , and  $-4^{\circ}\text{C}$  respectively. The improvement in performance of refrigeration system with mechanical sub-cooling cycle MSC compared with that for the system without MSC in function of COP and RE variations with time is shown in Figures 6 and 7 for R-134a and

in Figures 8 and 9 for R-404A. The optimization in COP value for system with MSC is about 14% and 12% at base load and load II respectively for R-134a and about 13% and 11% for R-404A as a result of sub-cooling which enhance the refrigeration effect relative to the specified work of compressors for the refrigeration system.

There is a significant improvement in RE of the system with MSC during operation period in range of 5% for R-134a and 4% for R-404A, this increase in RE reflects the advantage of using mechanical sub-cooling to increase the refrigeration effect by extending cooling area in the p-h diagram (as shown in Figure 1) which is occurs when the refrigerant sub-cooled under the saturation liquid line. The effect of refrigerant type on system performance can be indicated in the Figures 10, 11, 12 and 13 which show the variations of freezing room temperature, COP, pressure ratio and discharge temperature with time for the system with and without sub-cooling cycle at load II for refrigerants R-134a and R-404A. The comparison between the refrigerants shows a significant improvement in system performance with R-404A relative to R-134a. This result displays the advantage of using zeotropic mixed refrigerant such as R-404A due to its preferable thermo-physical and thermodynamic properties instead of refrigerant R-134a for improving the performance and energy saving of refrigeration system with sub-cooling cycle.

The enhancement in refrigeration system performance due to the sub-cooling effect using R-404A as a zeotropic mixture is resulted from the effect of glide temperature which is slightly higher than that for R-134a. Glide temperature represents the difference between the boiling temperatures for components of mixed refrigerant which is approximately zero for R-134a [13]. Figure 14 shows the work variation with time of the main and sub-cooling compressors of the refrigeration system at load (II) for refrigerants R-134a and R-404A. It can be seen from this figure that, the work of compressors for the system with R-134a is relatively higher than that for R-404A and can be noticed as well that, the variations in main compressor work is higher compared with sub compressor work for both refrigerants. The work for both compressors is slightly increases with time during first 35 min of operation due to the effect of thermal load applied on refrigeration system and then decreases within the rest time as a result of sub-cooling effect. The amount of energy saving of the refrigeration system with sub-cooling can be observed in the Figure (15) which indicates the variations of electrical power consumption with time for the system when operated with and without sub-cooling cycle at load II and refrigerants R-134a and R404A. It can be seen from the figure that, the power consumption of the system with MSC is less than that for system without MSC during system test period except for the first 25 minutes of operation which is required to maintain a steady operation for the system due to the effect of the thermal load in the freezing compartment which is relatively high at beginning of operation .The percentage decrease in power consumption for system when using sub-cooling is at average of 2.8% and 3.7% for the system with refrigerants R-134a and R-404A respectively. It is also observed from the figure that, the value of power consumption for system with sub-cooling is less than that for system without sub-cooling during most test period of system operation. This reduction in power consumption reflects the amount of energy saving particularly when the system is used for refrigerating relatively large spaces such as in the supermarkets for long period.

#### **CONCLUSIONS:**

It can be concluded that, integrating mechanical sub-cooling cycle in the refrigeration system is considered a feasible technique for energy saving and performance enhancement of the refrigeration system specifically when used in commercial



applications such as in supermarkets and refrigerating relatively large spaces. The enhancement in performance of the refrigeration system with mechanical sub-cooling compared with that for system without sub-cooling for R134a was about 5% in refrigeration effect and 14% in COP while for R-404A, the enhancement was in the range of 4% and 13% respectively. The energy saving of the refrigeration system with mechanical sub-cooling circuit in function of actual power consumption compared with that for system without sub-cooling was at average of 2.8% and 3.7% for R-134a and R-404A respectively.

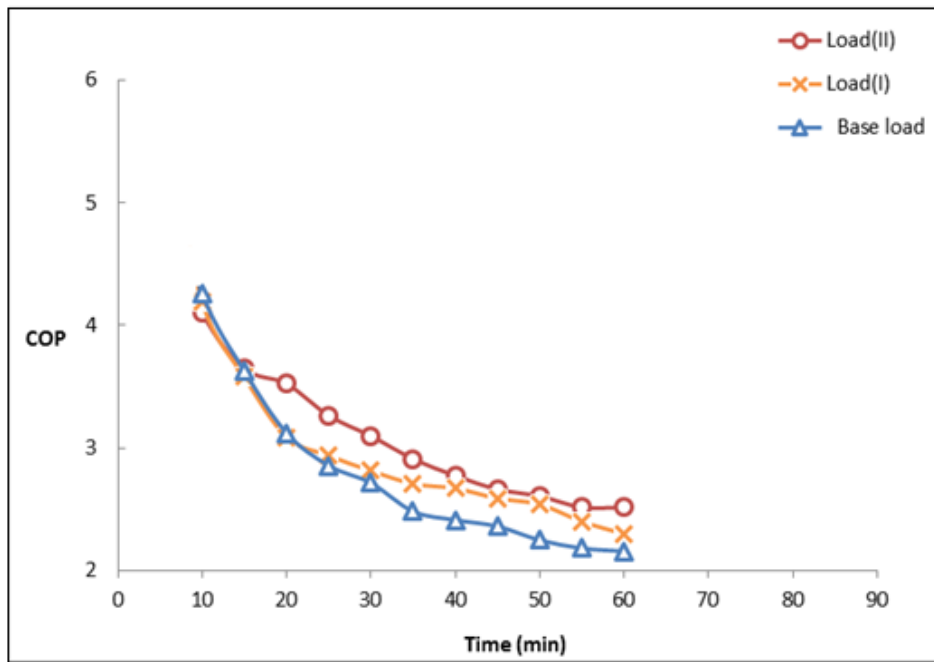

Figure (4) Coefficient of performance as a function of time for the system with sub-cooling at different loads for the refrigerant R-134a.

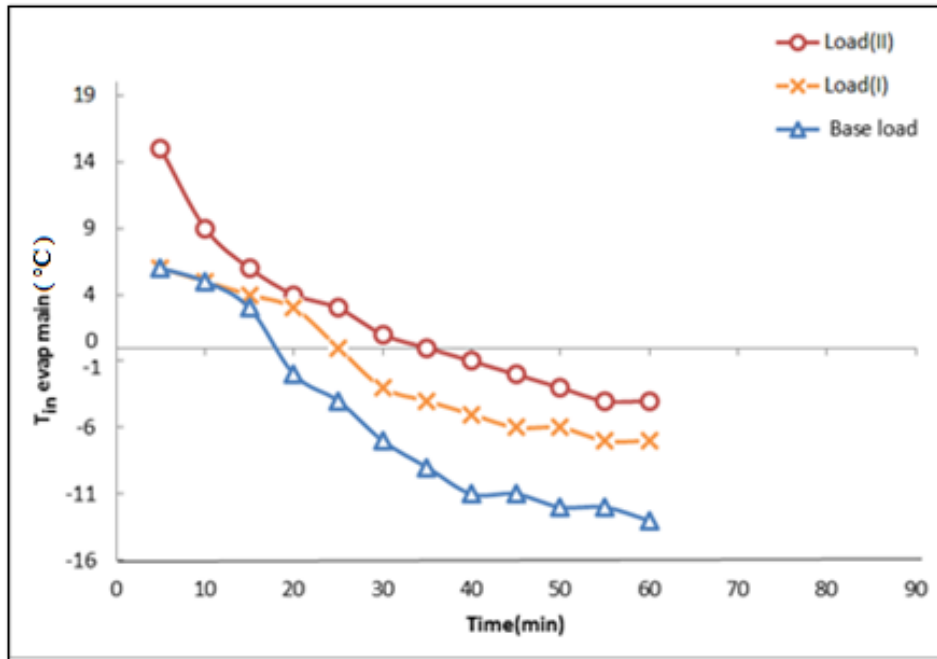

Figure (5) Evaporator inlet temperature as a function of time for the system with sub-cooling at different loads for the refrigerant R-134a

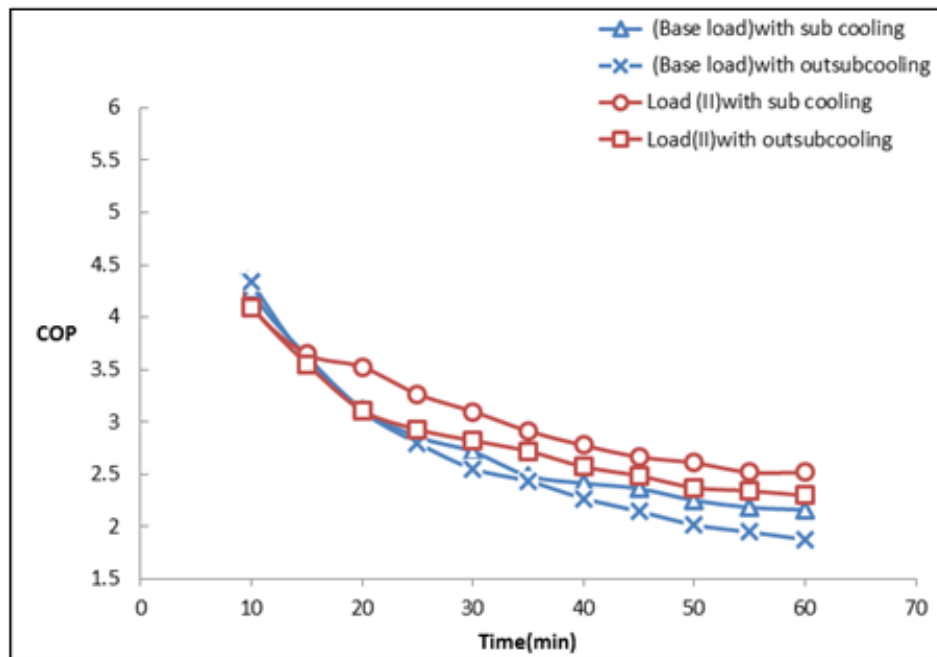

Figure (6) Coefficient of performance as a function of time for the system with and without MSC at different loads and refrigerant R-134a.

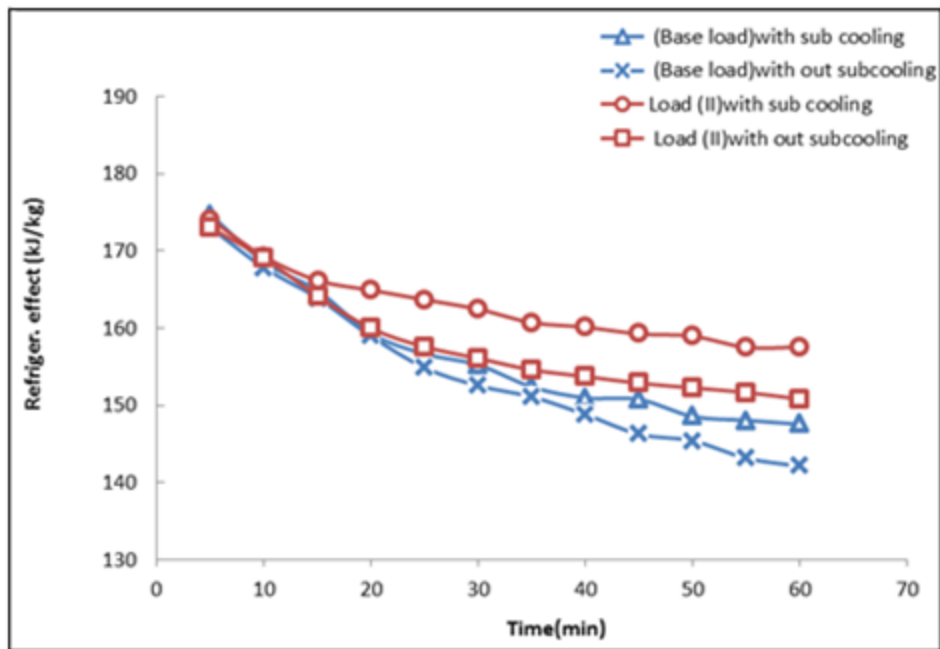

Figure (7) Refrigeration effect as a function of time for the system with and without MSC at different loads and refrigerant R-134a.

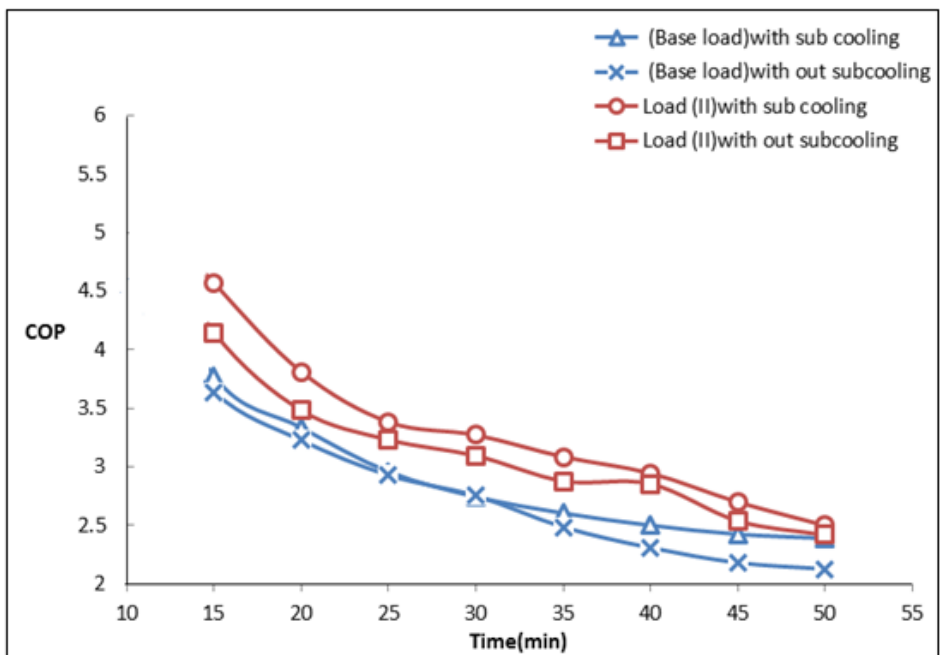

Figure (8) Coefficient of performance as a function of time for the system with and without MSC at different loads and refrigerant R-404A.

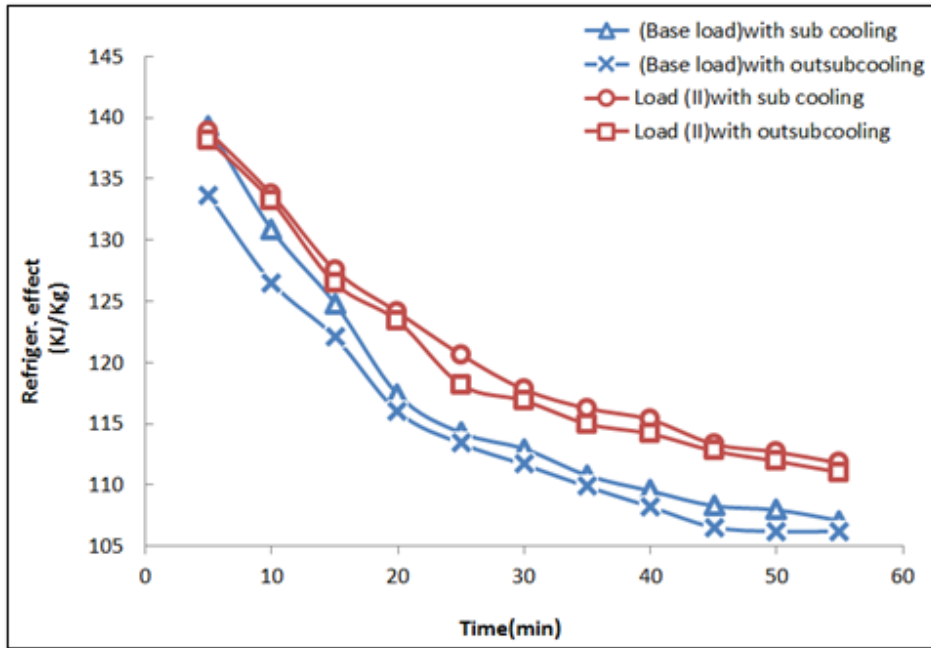

Figure (9) Refrigeration effect as a function of time for the system with and without MSC at different loads and refrigerant R-404A

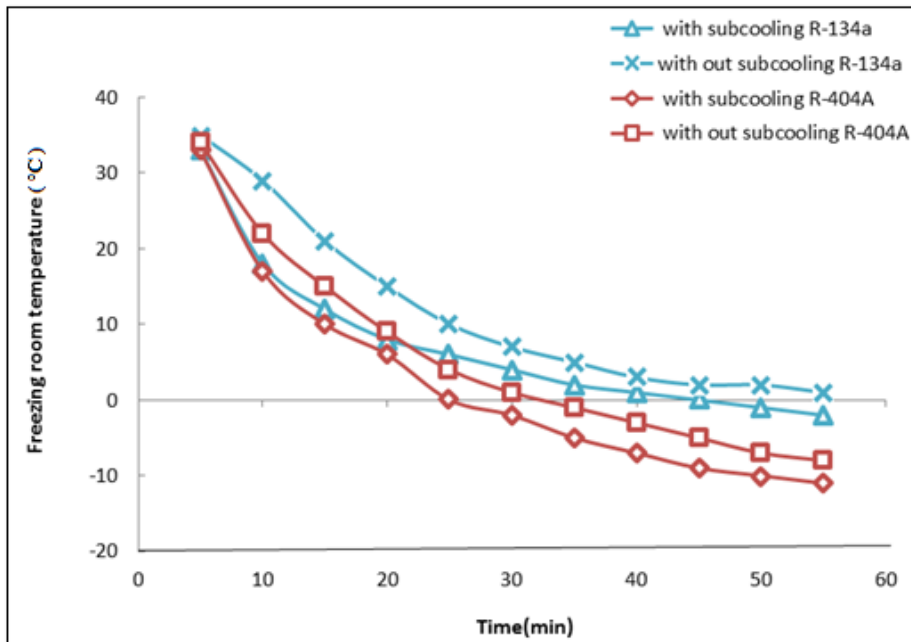

Figure (10) Variation of freezing room temperature with a time for the system with MSC and without MSC at load (II) for refrigerants R-134a and R-404A

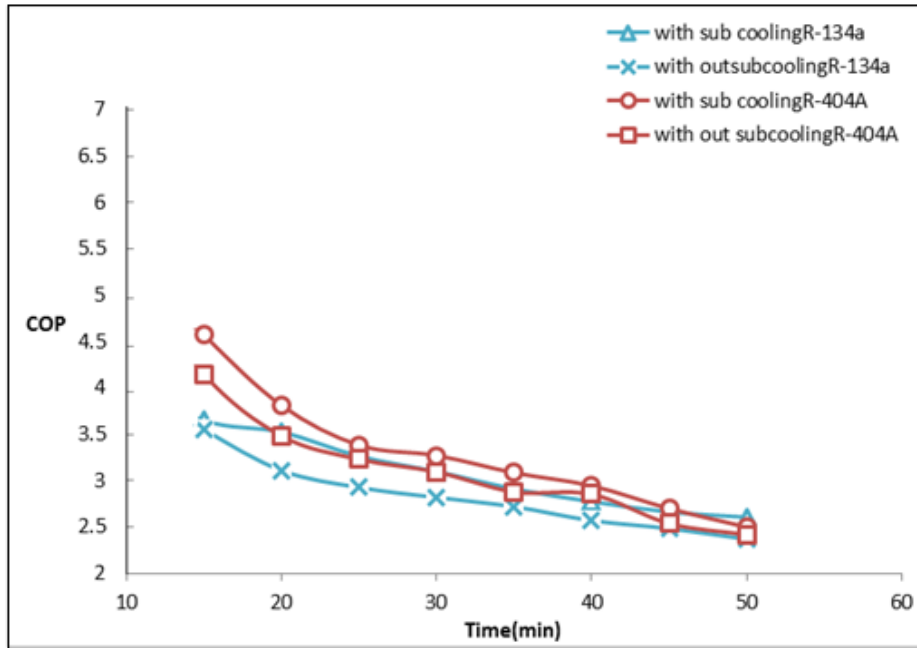

Figure (11) Coefficient of performance as a function of time for the system with and without MSC at load (II) for refrigerants R-134a and R-404A

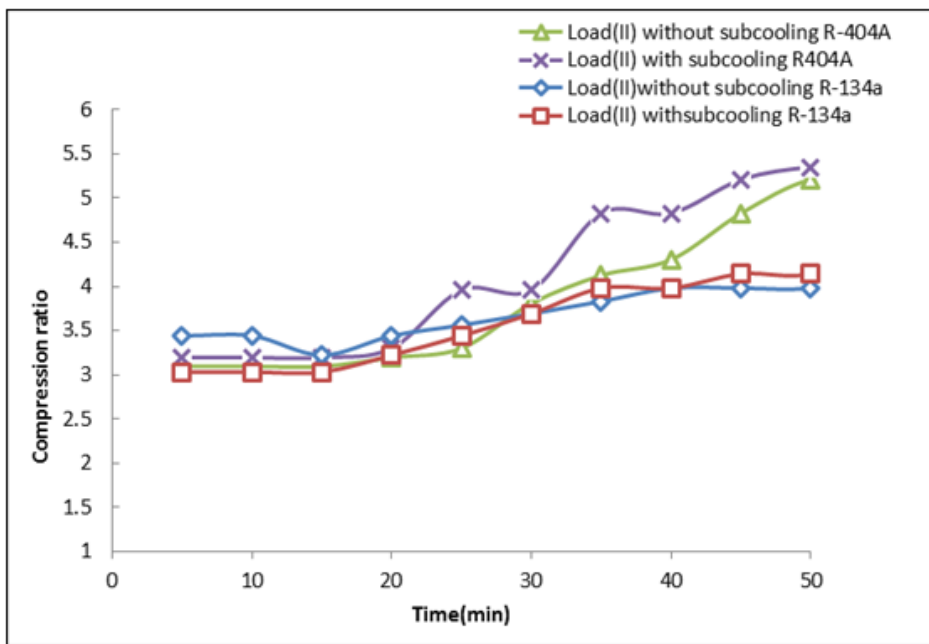

Figure (12) Variation of compression ratio with a time for the system with and without MSC at load (II) for refrigerants R-134a and R-404A

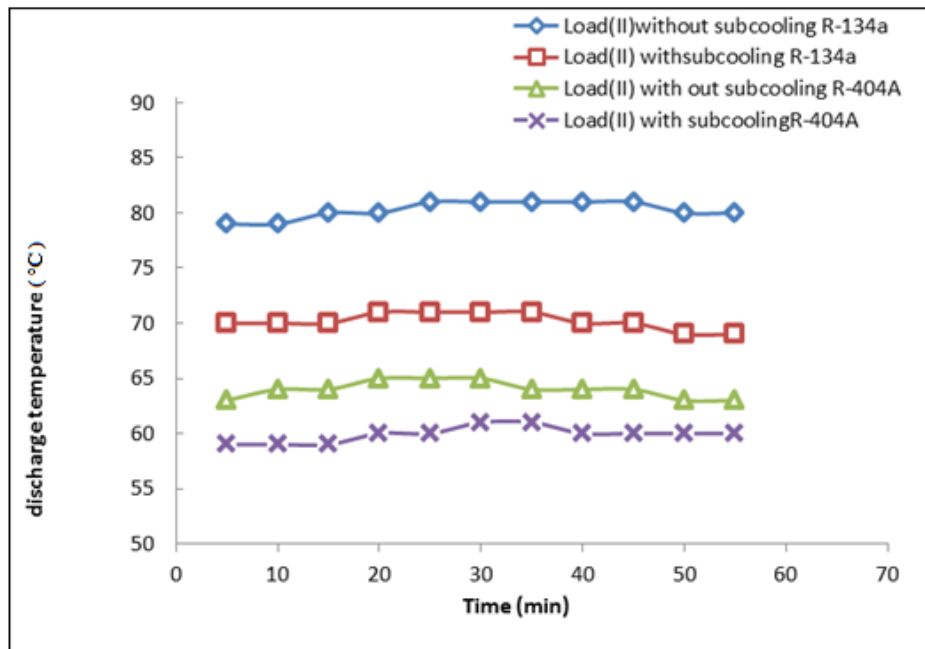

Figure (13) Variation of discharge temperature with a time for the system with and without MSC at load (II) for refrigerants R-134a and R-404A.

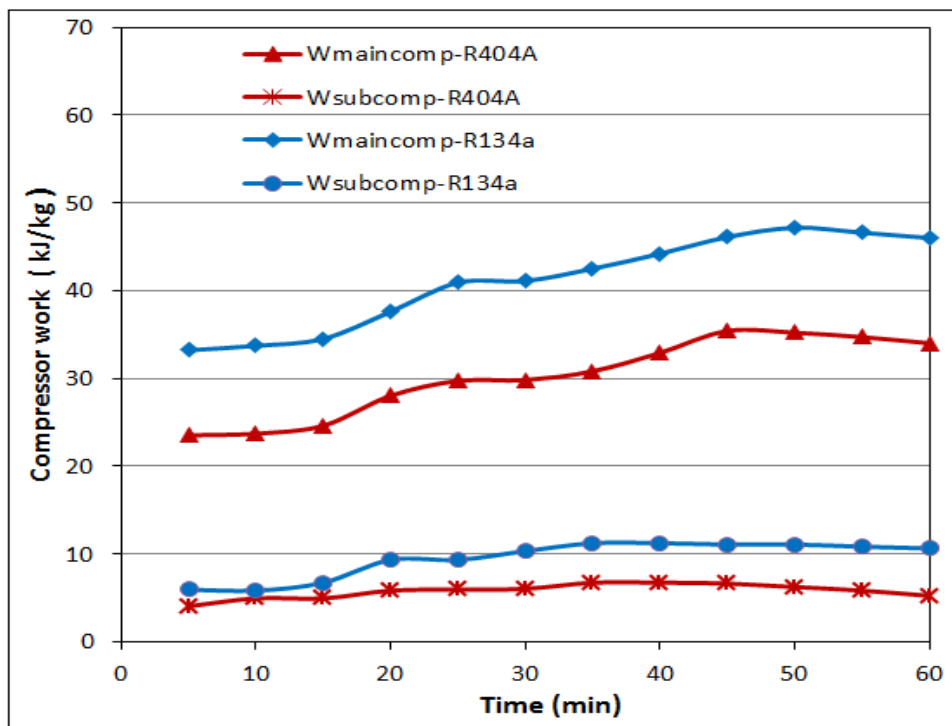
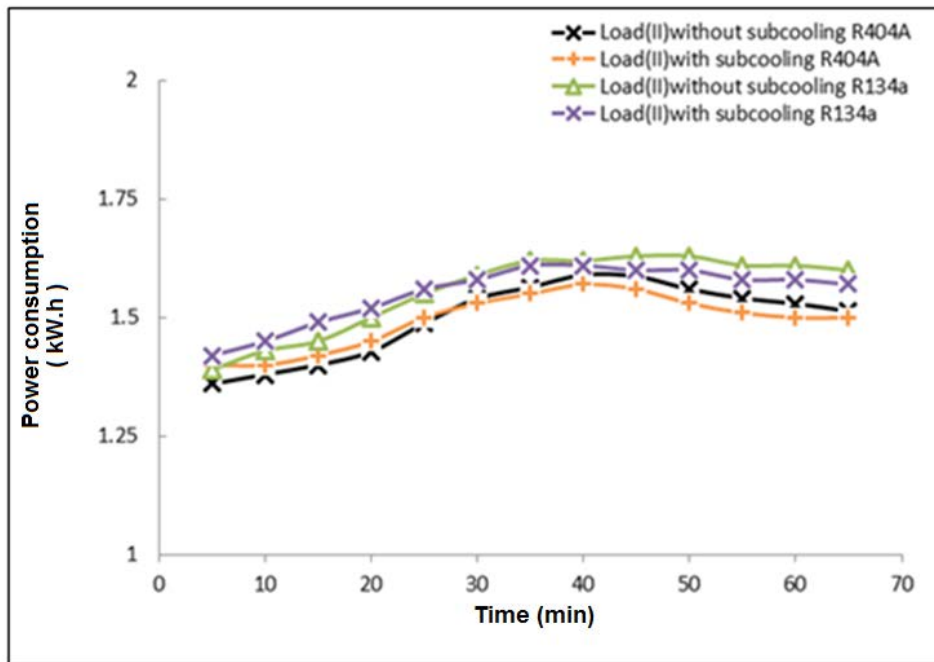

Figure (14) Work variation with time of the main compressor and sub-cooling compressor of the refrigeration system at load (II) for refrigerants R-134a and R-404A.



**Figure (15) Actual power consumption in (kW.h) as a function of time for the refrigeration system with and without MSC at load (II) for refrigerants R-134a and R-404A**

#### References:

- [1] Liang Yang, Chun-Lu Zhang, " Analysis on energy saving potential of integrated supermarket HVAC and refrigeration systems using multiple sub-coolers", Elsevier Energy and Buildings 42 (2010) 251–258.
- [2] Bilal Ahmed Qureshi and Syed M. Zubair, "The impact of fouling on performance of a vapor compression refrigeration system with integrated mechanical sub-cooling system", Elsevier Applied Energy 92 (2012) 750–762.
- [3] Bilal A.Q. ,Muhammad I., Mohamed A. A., and Syed M. Z., " Experimental energetic analysis of a vapor compression refrigeration system with dedicated mechanical sub-cooling" Elsevier Applied Energy 102 (2013) 1035–1041.
- [4] Lars S. Larsen and Claus Thybo," Potential energy savings in refrigeration systems using optimal set points", Proceedings of IEEE conference on control applications, Aalborg University, Denmark, 2004.
- [5] Ming-Jer Hsiao, Chiao-Hung Cheng, Ming-Chao Huang, Sih-Li Chen, "Performance enhancement of a sub cooled cold storage air conditioning system", Energy Conversion and Management 50 (2009) 2992–2998.
- [6] Torrella E., R. Llopis, R. Cabello, "Experimental evaluation of the inter-stage conditions of a two-stage refrigeration cycle using a compound compressor ", International journal of refrigeration 32(2009) 307-315.
- [7] Laeun Kwona, Yunho Hwanga, Reinhard Radermachera, Byungsoon Kimb, "Field performance measurements of a variable refrigerant flow (VRF) system with sub-cooler in educational offices for the cooling season ", Elsevier Energy and Buildings 49(2012) 300-305.
- [8] Khan J. R. and S. M. Zubair, " Design and rating of dedicated mechanical sub cooling vapour compression refrigeration systems " Proc. Inst. Mech. Eng. (2000) 214, 455-471.

- [9] Nguyen Q. Minhi, Neil J. Hewitti, and Philip C. Eames," Improved Vapour Compression Refrigeration Cycles: Literature Review and Their Application to Heat Pumps"; International Refrigeration and Air Conditioning Conference. Paper 795, Purdue University, 2006.
- [10] Thornton J.W., Klein S.A., Mitchell J.W.," Dedicated Mechanical Sub cooling Design Strategies for Supermarket Applications"; International Refrigeration and Air Conditioning Conference. Paper 191, Purdue University,1992.
- [11] Wang S. K. ," Handbook of air conditioning and refrigeration "; second edition, McGraw-Hill, New York, 2001.
- [12] Ibrahim Dincer, Mehmet Kanoglu," Refrigeration systems and applications", second edition, John Wiley & Sons, Ltd, United Kingdom, 2010.
- [13] Reinhard Rademacher and Yunho Hwang "Vapor Compression Heat Pumps with Refrigerant Mixtures", By Taylor & Francis Group, (2005).