

# Shear Strength Prediction for Two-Piles Caps Using Empirical Equations

Riyadh J. Aziz

Department of Civil Engineering  
Al-Nahrain University  
riyadhaziz48@yahoo.com

Ihsan A. Saib

Department of Civil Engineering  
Al-Nahrain University  
ishaarbaif@yahoo.com

Safaa D. Abdul-Hameed

Ministry of Construction &  
Housing  
safaa\_n1973@yahoo.com

## Abstract

This study involves analyzing of two piles-caps together with other available tested pile caps in literature. Many expressions are proposed in the current study to predict the diagonal cracking and ultimate shear strengths of pile caps using the nonlinear multiple-regression analysis to the available experimental data. The proposed expressions have minimum values of mean absolute error (MAE) and root mean square error (RMSE), while they have maximum values for coefficient of multiple determinations ( $R^2$ ).

For the prediction of diagonal cracking shear strength, two proposed expressions were compared with the available equations. The analysis of pile caps using these equations indicates that the proposed equations results in accurate values closer to experimental results than the available equations. While for the prediction of ultimate shear strength, two proposed expressions were compared with the available equations. The analysis of pile caps using these equations indicate that the proposed equations results in good agreement when compared with the results of the available equations.

**Keywords:** Cracking, Ultimate, Shear, Pile Cap, Regression.

## 1. Introduction

Nowadays, refined analysis of concrete structural members becomes necessary. The shear strength of such members is an important issue in structural design. Several modes of failure of concrete structural members were observed. For concrete pile caps, shear failure is the most critical and undesirable mode of failure.

Reinforced concrete members can resist shear forces through the development of several mechanisms. Shear failure in reinforced concrete members is resisted by providing transverse reinforcement. Hence, reinforced concrete design of pile caps is based on shear capacity of these members. Because of the complexity of shear mechanism of reinforced concrete members and the effect of various influencing parameters, it is difficult to establish an overall model to provide accurate estimation of shear strength. The ultimate shear strength of reinforced concrete members  $V_u$  is a function of shear capacity of concrete  $V_c$ , which in turn depends on influencing

parameters including concrete compressive strength  $f_c$ , ratio of tension reinforcement  $\rho_s$ , shear span to effective depth ratio ( $av/d$ ) and aggregate interlock aspects. This paper reviews some existing empirical formulas adopted by different Codes of practice to predict the diagonal shear strength  $V_{cr}$ , concrete shear strength  $V_c$ , and ultimate shear strength  $V_u$  of pile caps. It also is devoted to establish of empirical expressions to predict ultimate and diagonal shear strength of pile caps formulas for analysis of this type of reinforced concrete members based on available experimental data.

## 2. Experimental Data

Thirty tested pile caps are used for comparison and regression analysis process to derive equations for estimation the shear capacity of pile caps. Fourteen of these pile caps were recently tested for this purpose, Abdul-Hameed, 2015 [1]. The others sixteen pile caps have been tested and reviewed by Blevot and Fremy, 1967 [2] and Delalibera and Giongo, 2008 [3]. A brief description of the pile caps included in this database is listed in Table (1) and shown in Figure (1). Test results of these pile caps represent adequate data for analysis and comparison purposes because they include the important variables that affect the capacity and behavior of pile caps. The variables and their ranges are as follows:

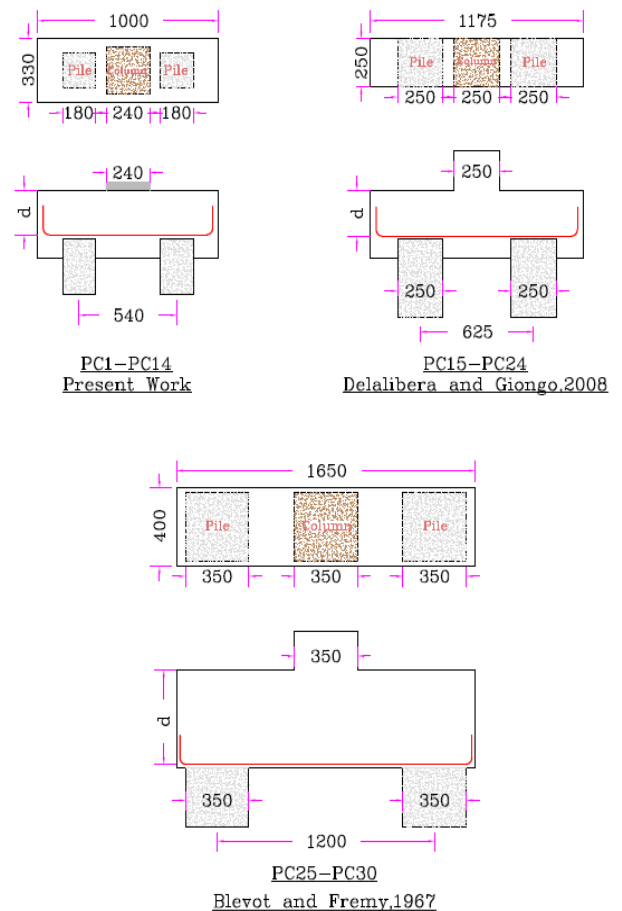
1. Shear span to effective depth ratio ( $av/d$ ) which varies between 0.6 and 1.25.
2. Concrete compressive strength  $f_c$  which is in the range between 23.1 MPa and 48.2 MPa.
3. Longitudinal flexural reinforcement ratio  $\rho_s$  which ranges between 0.38 % and 2.512 %.
4. Transverse shear reinforcement  $\rho_v$  and  $\rho_h$  which vary between 0 and 0.465 %.
5. Transverse dimensions ratio between pile and cap ( $lb/bw$ ) which varies from 0.545 to 1.
6. Effective depth  $d$  which is in the range between 250 and 895 mm.

**Table 1:** Database Components of Pile Caps Used in Parametric Study

Pile Cap	bw mm	d mm	f'c MPa	av/d	ρs %	ρv %	ρh %
PC1	330	270	29	1	0.677	0.233	0.197
PC2	330	270	29.8	0.8	0.677	0.291	0.175
PC3	330	270	32.1	0.6	0.677	0.401	0.162
PC4	330	270	31.1	1	0.677	0.155	0.262
PC5	330	270	29.5	1	0.677	0.310	0.131
PC6	330	270	29.4	1	0.677	0	0.393
PC7	330	270	30.7	1	0.677	0.465	0
PC8	330	270	29.9	1	0.677	0.155	0.131
PC9	330	270	29.4	1	0.677	0.310	0.262
PC10	330	270	30.8	1	0.677	0	0
PC11	330	270	30.7	1	0.38	0.233	0.197
PC12	330	270	32.8	1	1.128	0.233	0.197
PC13	330	270	39.3	1	0.677	0.233	0.197
PC14	330	270	48.2	1	0.677	0.233	0.197
PC15	250	250	40.6	1.25	2.512	0.101	0.158
PC16	250	250	40.6	1.15	2.512	0.104	0.149
PC17	250	250	32.8	1.25	2.512	0	0
PC18	250	250	28.9	1.25	2.01	0.101	0.158
PC19	250	250	32.8	1.25	2.512	0	0
PC20	250	350	31	0.9	1.954	0.208	0.217
PC21	250	350	31	0.75	1.954	0.228	0.199
PC22	250	350	32.4	0.9	1.954	0.000	0.000
PC23	250	350	28.9	0.9	1.563	0.208	0.217
PC24	250	350	32.4	0.9	1.954	0	0
PC25	400	495	23.1	1.2	2.44	0	0
PC26	400	495	43.2	1.2	2.03	0	0
PC27	400	700	27.3	0.85	1.72	0	0
PC28	400	700	44.6	0.85	1.45	0	0
PC29	400	895	32.1	0.67	1.35	0	0
PC30	400	895	46.1	0.67	1.13	0	0

**3. Existing Empirical Equations for Shear Strength Prediction**

Abdul-Hameed, 2015 illustrates and discusses the aforementioned provisions and guidelines that are used for the design of pile caps and deep beams. Several empirical formulas were proposed in literature and concrete building Codes for the prediction of reinforced concrete member resistance. These equations were proposed and used by some researchers and Codes of practice based on experimental data of tested pile caps and



**Figure 1:** Pile Caps Geometry and Section for Use in Statistical Analysis

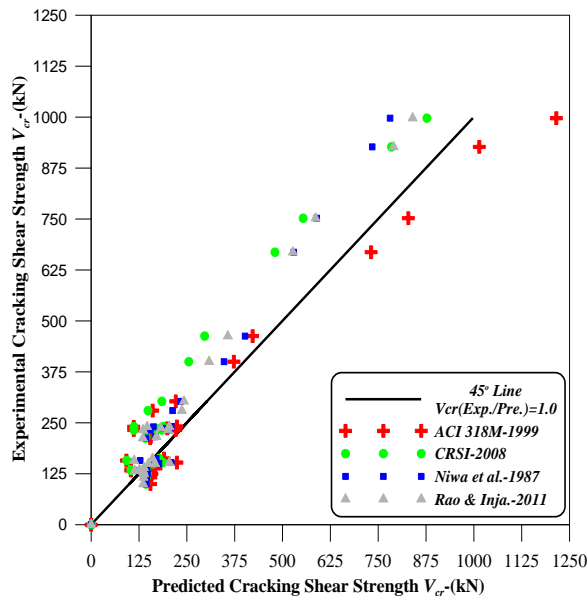
deep beams. For analysis purposes the reduction factor of shear strength will be taken as unity ( $\phi=1$ ). Therefore the ultimate shear strength is equal the nominal shear strength ( $V_u=V_n$ ).

**4. Results of Analysis for Prediction Diagonal Cracking Shear Strength- $V_{cr}$**

Analysis of pile caps was made by programming the adopted empirical equations of shear strength to calculate the required statistical properties of the obtained data base analysis, Abdul-Hameed, 2015 [1]. Figure (2) shows that the predicted diagonal shear strengths are more scattered from the observed diagonal shear strengths.

The results show that CRSI-2008 Handbook [4] equation is more conservative than other equations (Avg.=1.257) , while Rao and Injaganeri, 2011 [5] equation is less conservative than others (Avg.= 1.1489). It can be noticed that ACI 318M-99 [6] provisions are less accurate than other equations, where it has the highest values of S.D., C.O.V., and Maximum Value. Also, the ACI 318M-99 [6] equation has the smallest value of C.C. in comparison with other equations. Finally, Niwa et al., 1987 [7] expression gives the most accurate results because

of the convergence to the experimental data. It has the smallest value of (C.O.V. =20.796%) and the highest value of (C.C. =0.989).



**Figure 2:** Comparison between Experimental and Empirical Results- $V_{cr}$

### 5. Refined Models for Prediction of Diagonal Cracking Shear Strength- $V_{cr}$

The results of statistical analysis illustrated in Figure (2) show that the empirical equations of ACI 318M-99 [6] and CRSI-2008 Handbook [4] are not the appropriate models to predict correctly the diagonal shear strength  $V_{cr}$  of pile caps, where they have the greatest standard deviations (S.D.), coefficients of variations (C.O.V.%) and ranges. While, Niwa et al., 1987 [7] and Rao and Injaganeri, 2011 [5] empirical equations have the highest value of coefficients of correlation (C.C.). Therefore, the proposed empirical equations of this work must be chosen to reflect the actual behavior of reinforced concrete pile caps predicted by Niwa et al., 1987 [7] and Rao and Injaganeri, 2011 [5] can be used for this purpose.

In order to develop the design models for predicting the diagonal shear strength  $V_{cr}$  of the pile caps, the parameters influencing the shear strength which were identified and mentioned in Section two will be used. The influence of pile cap size (i.e. effective depth  $d$ ) along with other influencing parameters is also considered.

Parametric study using experimental selective database of thirteen data points are segregated on the diagonal  $V_{cr}$  and nominal  $V_n$  shear strength of reinforced concrete pile caps. These are carried out to be used in refined design equations through nonlinear regression analysis to evaluate the unknown coefficients of the proposed empirical formulas. The proposed formulas for cracking shear strength include three terms. The first term

is related to the compressive strength of concrete  $f'c$  and percentage of the longitudinal reinforcement  $\rho_s$ , therefore it can be represented as one of the following fourth proposed forms:

$$\begin{aligned}
 1- & A \times f'c^B \times \rho_s^C \\
 2- & A \times (f'c^B + \rho_s^C) \\
 3- & A \times (f'c^B + C \times \rho_s) \\
 4- & A \times f'c^B \times k^C
 \end{aligned} \dots (1)$$

Where  $k$  is the depth ratio of un-cracked compression zone calculated as follows:

$$\begin{aligned}
 k &= \sqrt{\rho_s n^2 + 2\rho_s n} - \rho_s n \\
 n &= E_s / E_c \\
 E_c &= 4700\sqrt{f'c} \quad f'c \leq 42 \\
 E_c &= 3320\sqrt{f'c} + 6900 \quad f'c > 42
 \end{aligned} \dots (2)$$

Where  $n$  is the modular ratio of steel reinforcement to concrete,  $E_s$  is the Young modulus of elasticity for steel reinforcement taken as (200GPa) and  $E_c$  is the concrete modulus of elasticity. The fourth formula involves contribution of percentage of the longitudinal reinforcement  $\rho_s$  through the use  $k$  value which depends on the form presented in equation (1), where the diagonal shear strength  $V_{cr}$  increases as  $k$  value is increased due to increasing the compression region depth and decreasing the tension region depth. This will reduce the tensile stresses leading to delay appearance of the cracks, where the flexural stresses are still within the elastic stage at appearance of cracks.

The second term in the proposed expressions depends on the pile cap geometry or shear span to effective depth ratio ( $av/d$ ). It can be represented as one of the following three proposed forms:

$$\begin{aligned}
 5- & (av/d)^D \\
 6- & \frac{D}{E + (av/d)^F} \\
 7- & D + \frac{E}{(av/d)^F}
 \end{aligned} \dots (3)$$

where  $D$  is the unknown coefficient to be determined.

The pile cap size effect on diagonal cracking shear  $V_{cr}$  is not incorporated in the design models of the **ACI 318 Building Codes** and **CRSI-Handbook**, in which the shear strength of reinforced concrete large size member is overestimated by their empirical equations, since the shear strength decreases as the member depth increases. Hence, there is a need to account for an appropriate size effect term for predicting shear strength of practical range of sizes of reinforced concrete members.

The third term is included in the proposed expressions depends on the effective depth  $d$ , in which it is included to account for the size effect on diagonal shear strength of pile cap. It can be represented by the following form:

$$8 - \left(\frac{G}{d}\right)^H \quad \dots (4)$$

where  $G$  is unknown coefficient to be determined. The general proposed formula of calculating diagonal shear stress  $v_{cr}$  will consist of multiplication of the mentioned three terms and

the diagonal shear strength  $V_{cr}$  can be calculated by multiplying this stress by  $(bw*d)$ . These proposals will produce twelve formulas for  $V_{cr}$ . The coefficients and exponential (A-H) of these formulas are obtained by nonlinear regression analysis. **Data Fit-2014 [8]** program has been used to perform the regression analysis. Table (2) shows values of the coefficients and the final shape of the formulas after adjusting the coefficients to simple values that have insignificant effect on their accuracy.

**Table 2:** Listing of Final Formulas for the Proposed Empirical Equations to Predict the Diagonal Cracking Shear Strength- $V_{cr}$

Mathematical Formulas
$v_{cr} = 1.4 \times (f'c)^{0.42} \times (\rho_s)^{0.48} \times (av/d)^{-0.95} \times (1/d)^{0.2}$
$v_{cr} = 0.65 \times (f'c)^{0.42} \times (\rho_s)^{0.48} \times \left(\frac{1.1}{(av/d)^{0.4} - 0.5}\right) \times (1/d)^{0.2}$
$v_{cr} = 0.75 \times (f'c)^{0.42} \times (\rho_s)^{0.48} \times \left(0.75 + \frac{1.125}{(av/d)^{1.45}}\right) \times (1/d)^{0.2}$
$v_{cr} = 0.55 \times (f'c^{0.5} + \rho_s^2) \times (av/d)^{-1} \times (1/d)^{0.125}$
$v_{cr} = 0.7 \times (f'c^{0.5} + \rho_s^2) \times \left(\frac{1.1}{0.4 + (av/d)^{1.5}}\right) \times (1/d)^{0.125}$
$v_{cr} = 0.7 \times (f'c^{0.5} + \rho_s^2) \times \left(\frac{1.3}{(av/d)^{0.65}} - 0.53\right) \times (1/d)^{0.125}$
$v_{cr} = 0.2 \times (f'c^{0.82} + 12.75\rho_s) \times (av/d)^{-1} \times (1/d)^{0.2}$
$v_{cr} = 0.9 \times (f'c^{0.82} + 12.5\rho_s) \times \left(\frac{1.1}{6 \times (av/d)^{0.8} - 1}\right) \times (1/d)^{0.2}$
$v_{cr} = 0.15 \times (f'c^{0.82} + 12.5\rho_s) \times \left(0.25 + \frac{1.06}{(av/d)^{1.2}}\right) \times (1/d)^{0.2}$
$v_{cr} = 12.3 \times f'c^{0.7} \times k^{1.25} \times (av/d)^{-1.1} \times (1/d)^{0.5}$
$v_{cr} = 6.45 \times f'c^{0.7} \times k^{1.25} \times \left(\frac{0.95}{(av/d)^{0.5} - 0.5}\right) \times (1/d)^{0.5}$
$v_{cr} = 5.85 \times f'c^{0.7} \times k^{1.25} \times \left(0.95 + \frac{1.12}{(av/d)^{1.85}}\right) \times (1/d)^{0.5}$

The error values will be calculated to investigate the accuracy and the performance of each proposed formula. Three statistical parameters are selected to make the comparison between the results of experimental results and the proposed empirical formulas. These include mean absolute error (MAE), root mean square

error (RMSE) and coefficient of multiple determinations ( $R^2$ ),

Kennedy and Neville, 1986 [9]. These coefficients can be obtained using the following expressions:

$$MAE = \frac{1}{N} \sum_{i=1}^N |x_i - y_i|$$

$$RMSE = \sqrt{\frac{\sum_{i=1}^N (x_i - y_i)^2}{N}} \quad \dots (5)$$

$$R^2 = 1 - \frac{SSE}{SST} = 1 - \frac{\sum_{i=1}^N (x_i - y_i)^2}{\sum_{i=1}^N (x_i - \bar{x})^2}$$

Where

SSE measures the "unexplained" variation (i.e. sum of the squares of the residuals).

SST measures the variation in the experimental or observed shear strength.

$x_i$  is the experimental value of shear strength for a certain pile cap.

$\bar{x}$  is the average value of experimental values for all pile caps.

$y_i$  is the predicted value of shear strength for a certain pile cap.

Table (3) shows the superiority of proposed models over those sited in literature based on number of nonlinear iterations, (MAE), (RMSE) and ( $R^2$ ). All equations show excellent accuracy of fitting ( $R^2$ ) closer to unity. This reflects the reasonable accuracy of these equations in comparison with the existing empirical equations.

**Table 3:** Fittings Accuracy of Proposed Empirical Equations to Predict the Diagonal Cracking Shear Strength- $V_{cr}$

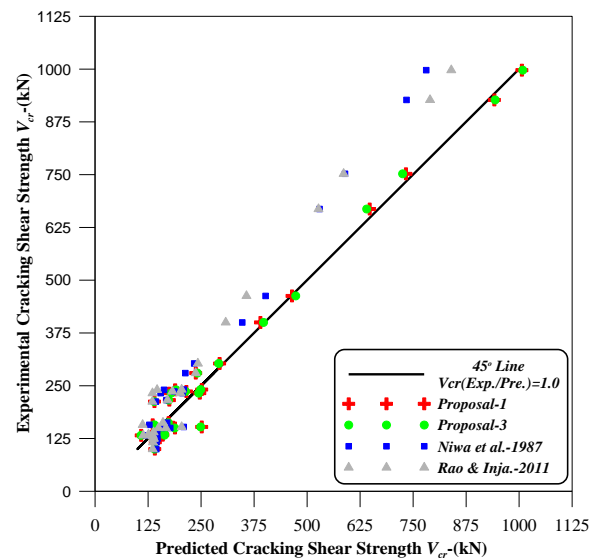
Proposal No.	(MAE)	(RMSE)	( $R^2$ )
<b>3</b>	<b>26.138</b>	<b>33.409</b>	<b>0.98016</b>
<b>1</b>	<b>25.895</b>	<b>33.593</b>	<b>0.97994</b>
2	26.949	33.904	0.97957
8	27.088	33.926	0.97954
9	27.102	33.926	0.97954
7	26.932	33.946	0.97952
5	28.132	34.824	0.97845
6	28.244	34.831	0.97844
4	28.329	34.951	0.97829
12	50.711	76.723	0.96930
11	51.236	77.237	0.96894
10	52.026	77.295	0.96831

For detailed comparison between the proposed equations and existing equations, only equations of Proposal 1 and proposal 3 are selected, as they have the minimum values of (MAE) and (RMSE) engaged with maximum values for coefficient of multiple determinations ( $R^2$ ). These results illustrate the accurate convergence between test results and analytical results by using these two equations where all ratios are generally close to unity for all pile caps. Finally, the empirical

equations of proposal 1 and proposal 3 can be used to predict the diagonal cracking shear strength  $V_{cr}$ .

### 6. Comparison between Proposed and Existing Equations of $V_{cr}$

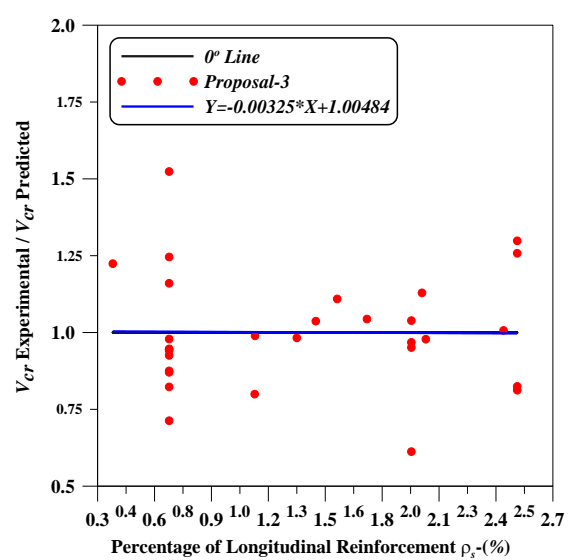
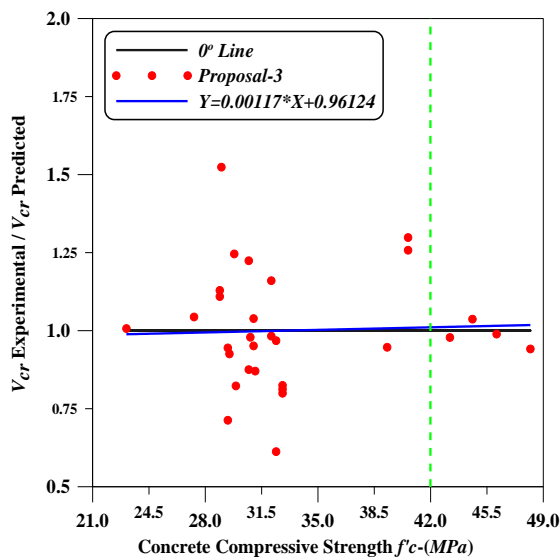
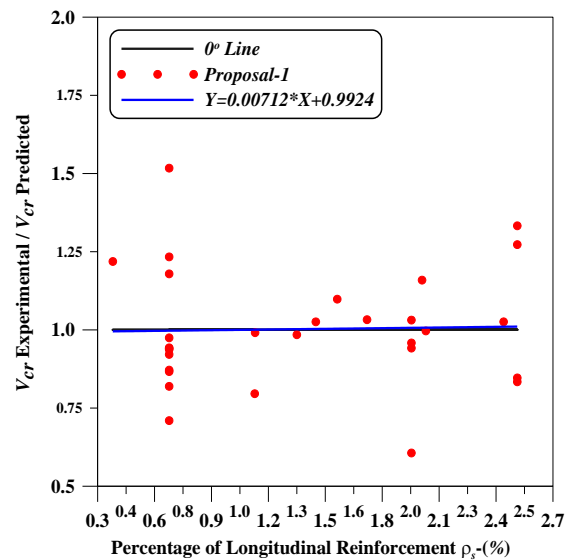
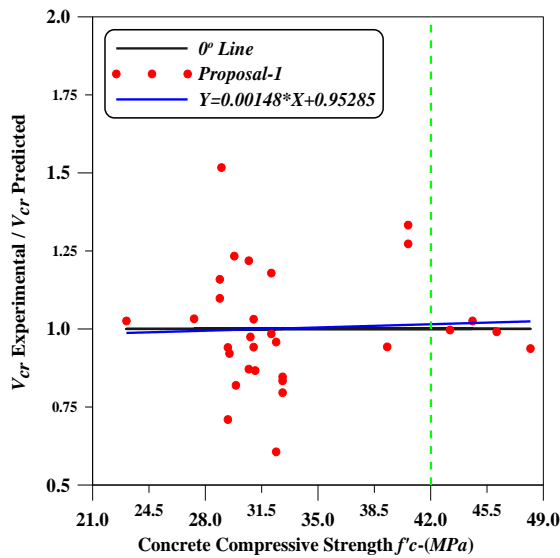
Figure (3) shows comparison between experimental and predicted diagonal shear strength  $V_{cr}$  for existing and proposed empirical equations. This figure shows the good correlation between the experimental and theoretical results for proposed equations by comparison with existing equations.



**Figure 3:** Comparison between Experimental and Predicted Cracking Shear Strength- $V_{cr}$  for Existing and Proposed Equations

Figure (3) also shows underestimation or conservatism of existing equations by Niwa et al., 1987 [7] and Rao & Injaganeri, 2011 [5], where the data points of the existing equations are dispersed, while the data points of the proposed equations are convergent among themselves and close to the 45° line (i.e.  $V_{Exp.} = V_{Pre.}$ ).

Figure (4) shows the ratio of experimental to predicted diagonal cracking shear strengths (i.e. relative shear strength) versus concrete compressive strength  $f'_c$  for the two proposed equations. The relative shear strength values are convergent for all values of  $f'_c$  and the fit lines of the results using these two equations with small slope equal to about (+0.15%) for proposal 1 equation and the slope equal to about (+0.12%) for proposal 3 equation. Figure (4) also, shows that the two proposed equations are valid for different values of concrete compressive strength even for ( $f'_c \geq 42$ MPa). They give relative shear strength very close to unity.

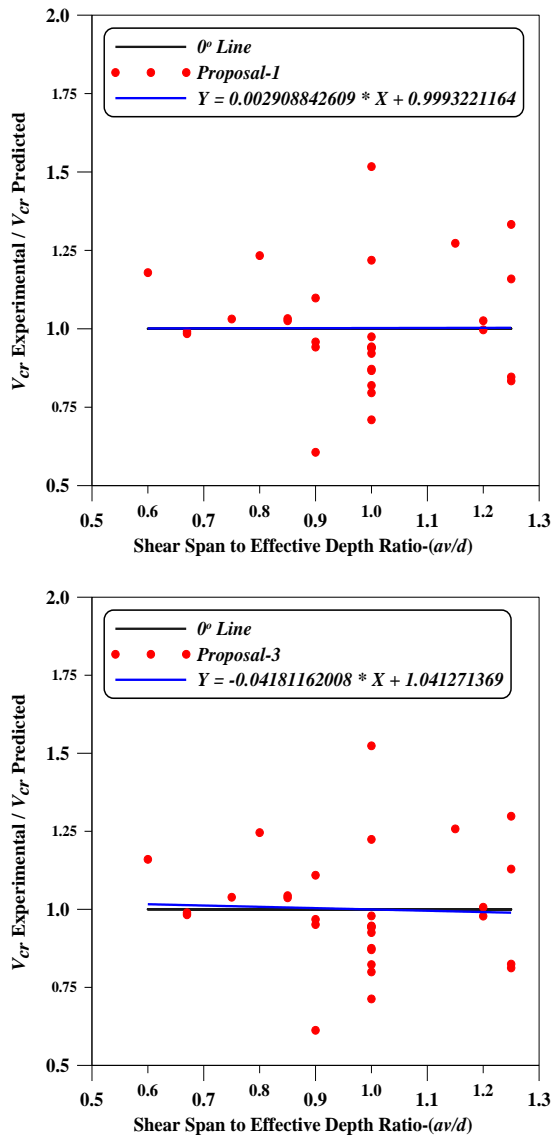


**Figure 4:** Concrete Compressive Strength  $f'c$  versus Ratio of Experimental to Predicted Cracking Shear Strengths- $V_{cr}$

**Figure 5:** Percentage of Longitudinal Reinforcement  $\rho_s$  versus Ratio of Experimental to Predicted Diagonal Shear Strengths- $V_{cr}$

Figure (5) shows the ratio of experimental to predicted diagonal or cracking shear strengths  $V_{cr}(Exp./Pre.)$  (i.e. relative shear strength) versus percentage of longitudinal flexural reinforcement  $\rho_s$ . For the two proposed equations, the relative shear strength values converge for all values of  $\rho_s$  and the fit lines of the results obtained using these two equations with small slope equal to about (+0.712%) for proposal 1 equation and slope equal to (-0.325%) for proposal 3 equation.

Figure (6) shows the ratio of experimental to predicted diagonal or cracking shear strengths  $V_{cr}(Exp./Pre.)$  versus  $(av/d)$  ratio. For the two proposed equations, the relative diagonal shear strength values converge for all values of  $(av/d)$  ratio and the fit lines of results of these two equations have slope equal to about (+0.3%) for proposal 1 equation and slope equal to about (-4%) for proposal 3 equation and are very close to unity line (i.e.  $0^\circ$  line). Also the data points are very close to unity line in comparison with data points of existing equations.

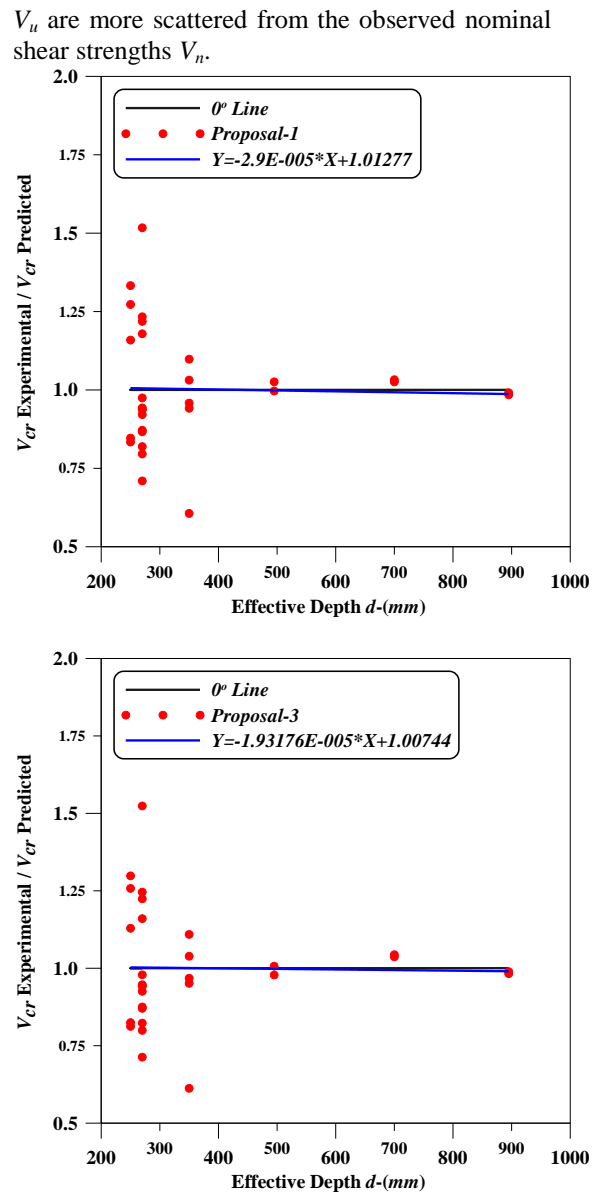


**Figure 6:** Shear Span to Effective Depth Ratio ( $av/d$ ) versus Ratio of Experimental to Predicted Diagonal Shear Strengths- $V_{cr}$

Figure (7) shows the ratio of experimental to predicted diagonal or cracking shear strengths  $V_{cr}(Exp./Pre.)$  versus effective depth  $d$ . For the two proposed equations, the relative diagonal shear strength values converge for all values of  $d$  and the fit line of results of these two equations is very close to unity line.

**7. Results of Analysis for Prediction Nominal Shear Strength- $V_n$**

Analysis of pile caps was made by programming the adopted empirical equations of nominal shear strength  $V_n$  using **Microsoft office-2007 Excel** program to calculate the required statistical properties for obtained data base analysis, Abdul-Hameed, 2015 [1]. Figure (8) shows that the predicted ultimate shear strengths



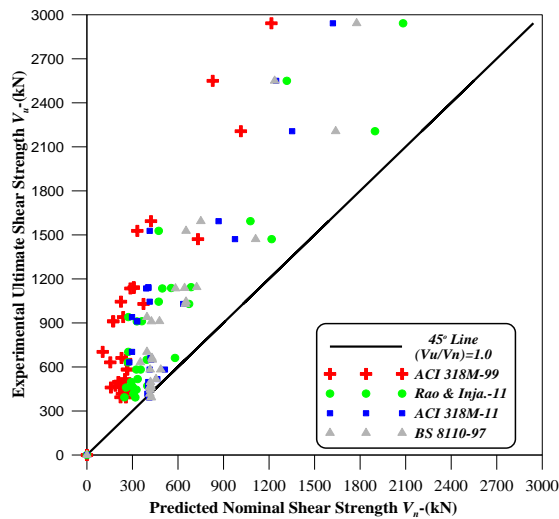
**Figure 7:** Effective Depth  $d$  versus Ratio of Experimental to Predicted Diagonal Shear Strengths- $V_{cr}$

The results show that the ACI 318M-99 [6] and ACI 318M-11 [10] equations are conservative as compared with other equations (Avg.= 3.095 & Avg.= 1.837 ), while Rao & Injaganeri, 2011 [5] and BS 8110-97 [11] give results slightly less than the experimental results where average values obtained using these equations are (Avg.= 2.028 & Avg.= 1.522 ) respectively. This means that all of these equations are significantly underestimate the ultimate shear strength. The ACI Code provisions provide high safety factor especially when the reduction factor  $\phi$  is used to reduce the ultimate shear strength ( $V_u = \phi V_n$ ).

ACI 318M-99 [6] and ACI 318M-11 [10] provisions are less accurate than the equations of Rao & Injaganeri, 2011 [5] and BS 8110-97 [11] because they give maximum value of (C.O.V.

=41.462% & C.O.V. =42.382%) and maximum values of (S.D. =1.283 & S.D. =0.778). Also the ACI 318M-99 [6] and ACI 318M-11 [10] provisions have little accuracy in comparison with other equations where they give maximum value of (Max. =6.774 & Max. =3.695) and maximum value of (Range=5.246 & Range=2.743).

BS 8110-97 [11] equation and Rao & Injaganeri, 2011 [5] equation have good accuracy in comparison with the other equations where their results are generally consistent with test results. Values of C.O.V. for these equations are generally small, where they are (28.059% & 30.241%) respectively while values of C.C. are the largest for BS 8110-97 [11] equation (0.964) and for Rao & Injaganeri, 2011 [5] equation (0.947) respectively. The values of Range for these two equations are (1.451) and (2.282) respectively. In general, BS 8110-97 [11] and Rao & Injaganeri, 2011 [5] equations are better than the other empirical equations depending on accuracy and safety criteria. Therefore, these two equations can be used for calculating the ultimate shear strength of pile caps with accepted accuracy and safety.



**Figure 8:** Comparison between Experimental  $V_u$  and Empirical- $V_n$  Results

**8. Refined Models for Predicting Ultimate Shear Strength- $V_u$**

The results illustrated in Figure (8) show that the empirical equations of ACI 318M-99 [6] and ACI 318M-11 [10] Building Code are not the appropriate models to accurately predict the ultimate shear strength ( $V_u=V_n$ ) of pile caps, where they have greatest standard deviations (S.D.), coefficients of variations (C.O.V.%) and ranges. While, BS 8110-97 [11] and Rao and Injaganeri, 2011 [5] empirical equations have the highest value of coefficients of correlation (C.C.).

Therefore, the new proposed empirical equations of this study have been chosen to reflect the true behavior of reinforced concrete pile caps, where two of these equations are performed based on BS 8110-97 [11] and Rao and Injaganeri, 2011 [5] empirical equations.

The new equations are empirical formulas based on the relation between the ultimate shear capacity ( $V_u=V_n$ ) and the main parameters that affect this capacity. Certainly the proposed equations will contain some coefficients and exponential in their terms and parts. These unknowns will be determined by nonlinear regression analysis for experimental data based on adopted formulas. The ultimate shear strength expression ( $V_u=V_n$ ) consists of two parts. The first part is concrete contribution  $V_c$  and the second part is web reinforcement steel contribution  $V_s$ . Construction process of the ultimate shear strength empirical expression will be presented in two stages:

- 1- Construction of shear reinforcement steel strength expression  $V_s$ .
- 2- Construction of concrete strength expression  $V_c$ .

**8.1 Proposed Equation for Shear Contributed by Reinforcement- $V_s$**

According to ACI 318M-99 [6] and earlier editions; the relative amounts of vertical and horizontal transverse shear reinforcement for deep beams are based on equation (6). By making some modification on this equation using provisions of recent ACI 318M-02 [12] and latest editions for D-regions; new coefficients  $K_v$  and  $K_h$  have been proposed and generated as weighting factors for the relative effectiveness of the vertical and horizontal transverse shear reinforcement.

$$V_s = [\rho_v \times K_v + \rho_h \times K_h] \times f_{y_v} \times bw \times d$$

$$K_v = \frac{1 + (l_n / d)}{12}$$

$$K_h = \frac{11 - (l_n / d)}{12} \quad \dots (6)$$

$$K_v + K_h = 1.0$$

$$l_n / d \leq 5 \quad \text{Deep Member}$$

Equation (7) demonstrates the process of estimating the contribution of transverse shear reinforcement as follows:

$$V_s = [\rho_v \times K_v + \rho_h \times K_h] \times f_{y_v} \times bw \times d$$

$$K_v = \frac{1 + (av / d)}{6}$$

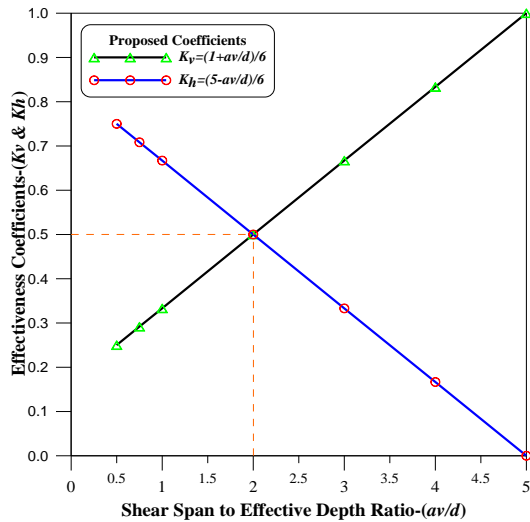
$$K_h = \frac{5 - (av / d)}{6} \quad \dots (7)$$

$$K_v + K_h = 1.0$$

$$av / d \leq 2.0 \quad \text{D-region}$$



These relations are based on the ratio of shear span to effective depth ( $a_v/d$ ) instead of clear span to effective depth ratio ( $l_r/d$ ). Figure (9) shows the variation of the proposed effectiveness coefficients ( $K_v$  &  $K_h$ ) with respect to the shear span to effective depth ratio ( $a_v/d$ ).



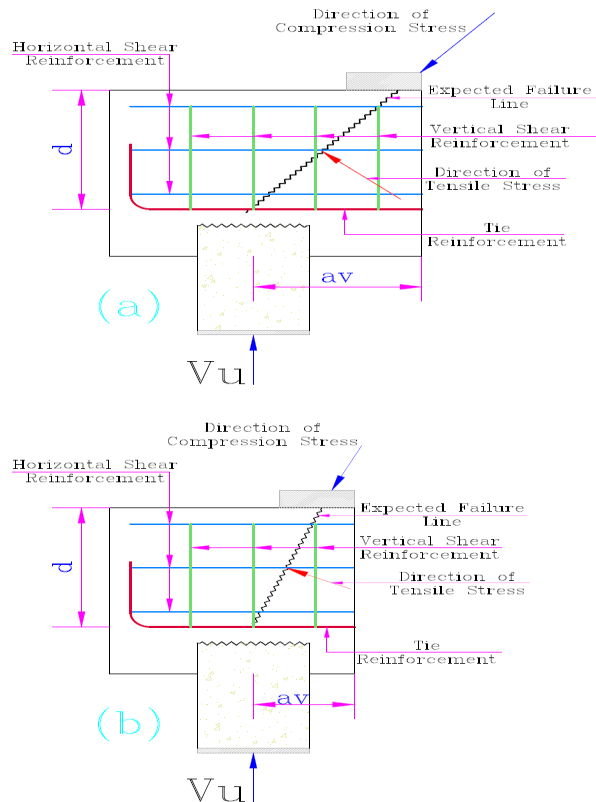
**Figure 9:** Proposed Effectiveness Coefficients for Vertical & Horizontal Transverse Shear Reinforcements

This proposal seems rational since the influence of shear reinforcement is affected by ( $a_v/d$ ) ratio. The vertical reinforcement has little effect when ( $a_v/d$ ) ratio is small where the angle between the failure line and axis of vertical stirrups is small that makes them approximately able to carry the compression stresses rather than the tension stresses leading to a reduction in their efficiency for resisting the shear stresses. But when ( $a_v/d$ ) ratio is high, which means that the angle between the failure line and the axis of vertical stirrups is large, which makes them able to carry the tension stresses that cannot be carried by concrete, Figure (10). On the contrary, the horizontal reinforcement is more efficient when the ( $a_v/d$ ) ratio is small where its axis is in the direction of tension stresses while its efficiency is low when the ( $a_v/d$ ) ratio is high, where its axis is far from direction of the tension stresses. The transverse shear reinforcement effect is obvious in tension regions when its axis is in the direction of tension stresses, as shown in Figure (10). In brief the vertical reinforcement shear strength is positively proportional to ( $a_v/d$ ) ratio while horizontal reinforcement shear strength is negatively proportional to ( $a_v/d$ ) ratio.

**8.2 Proposed Equations for Concrete Shear Strength- $V_c$**

The proposed empirical equation to predict concrete shear strength  $V_c$  is constructed using the

same procedures adopted for prediction of diagonal shear strength  $V_{cr}$ . The proposed formulas for concrete shear strength  $V_c$  will include four terms, where another fourth term is newly added.



**Figure 10:** Shear Failure Line Intersecting Shear Reinforcement and Direction of Stresses for; (a) Low ( $a_v/d$ ), (b) High ( $a_v/d$ )

The first term is related to the compressive strength of concrete  $f_c$  and percentage of the longitudinal reinforcement  $\rho_s$ , therefore it can be represented as a single formula from those given before by equations (1) and (2). The second term depends on the pile cap geometry or shear span to effective depth ratio ( $a_v/d$ ). It can be represented as a single formula composed from those given before by equation (3). The third term depends on the effective depth  $d$ , in which it is included to account the size effect on concrete shear strength  $V_c$  of pile cap. It can be represented by equation (4).

The fourth term is used to account for the effect of transverse dimensions ratio between pile support and pile cap ( $l_b/b_w$ ). It can be represented as follows:

$$9 - (l_b/b_w)^f \quad \dots (8)$$

The general formula for calculating concrete shear stress  $v_c$  will consist of multiplication of the mentioned four terms and the concrete shear force  $V_c$  can be calculated by multiplying this stress by ( $b_w*d$ ). Twelve formulas are resulted, and then

the shear reinforcement strength  $V_s$  is added to construct the general expression for estimating the nominal shear capacity ( $V_u=V_n$ ) as follows:

$$V_n = V_c + V_s \quad \dots (9)$$

Table (4) shows values of the coefficients and the proposed formulas after adjusting the coefficients to simple values that do not have effect on their accuracy.

**Table 4:** Proposed Empirical Formulas to Predict the Concrete Shear Strength- $V_c$

Mathematical Formulas
$V_c = 28.2 f'c^{0.9} \rho_s^{0.15} (av/d)^{-0.7} (1/d)^{0.7} (lb/bw)^{1.6}$
$V_c = 20.9 f'c^{0.9} \rho_s^{0.15} \left( \frac{5.9}{3.2+(av/d)^4} \right) (1/d)^{0.7} (lb/bw)^{1.6}$
$V_c = 9.3 f'c^{0.9} \rho_s^{0.15} \left( \frac{10}{(av/d)^{0.25}} - 7 \right) (1/d)^{0.7} (lb/bw)^{1.6}$
$V_c = 28.7 (f'c^{0.9} + \rho_s^{0.5}) (av/d)^{-0.7} (1/d)^{0.7} (lb/bw)^{1.7}$
$V_c = 14 (f'c^{0.9} + \rho_s^{0.75}) \left( \frac{8.5}{3+(av/d)^{3.55}} \right) (1/d)^{0.7} (lb/bw)^{1.7}$
$V_c = 116 (f'c^{0.9} + \rho_s^{0.65}) \left( \frac{6}{(av/d)^{0.03}} - 5.75 \right) (1/d)^{0.7} (lb/bw)^{1.7}$
$V_c = 29 (f'c^{0.9} + 0.7 \rho_s) (av/d)^{-0.7} (1/d)^{0.7} (lb/bw)^{1.7}$
$V_c = 27 (f'c^{0.9} + 0.7 \rho_s) \left( \frac{6}{4.25+(av/d)^{4.25}} \right) (1/d)^{0.7} (lb/bw)^{1.7}$
$V_c = 18.65 (f'c^{0.9} + 0.3 \rho_s) \left( \frac{4.6}{(av/d)^{0.25}} - 3 \right) (1/d)^{0.7} (lb/bw)^{1.7}$
$V_c = 38.35 f'c^{0.9} k^{0.25} (av/d)^{-0.7} (1/d)^{0.7} (lb/bw)^{1.6}$
$V_c = 24.35 f'c^{0.9} k^{0.25} \left( \frac{7}{3.25+(av/d)^4} \right) (1/d)^{0.7} (lb/bw)^{1.6}$
$V_c = 11.8 f'c^{0.9} k^{0.25} \left( \frac{11.25}{(av/d)^{0.225}} - 8 \right) (1/d)^{0.7} (lb/bw)^{1.6}$

Table (5) shows the superiority of proposed models based on number of nonlinear iterations, (MAE), (RMSE) and ( $R^2$ ). After regression analysis process, the resulting equations are used for analysis of the considered pile caps in this study. All equations show excellent accuracy of fitting ( $R^2$ ) closer to unity.

**Table5:** Fittings Accuracy of Proposed Empirical Equations to Predict the Concrete Shear Strength- $V_c$

Proposal No.	(MAE)	(RMSE)	( $R^2$ )
2	90.5729	115.323	0.96977
11	91.2079	116.054	0.96939
5	90.5846	116.065	0.96938
8	96.1873	118.355	0.96816
12	87.5528	119.114	0.96775
3	88.4222	119.773	0.96761
6	87.6541	119.138	0.96740
9	89.2448	120.879	0.96679
10	89.1661	122.255	0.96603
4	89.7873	122.591	0.96584
7	89.7825	122.652	0.96581
1	90.4220	123.402	0.96977

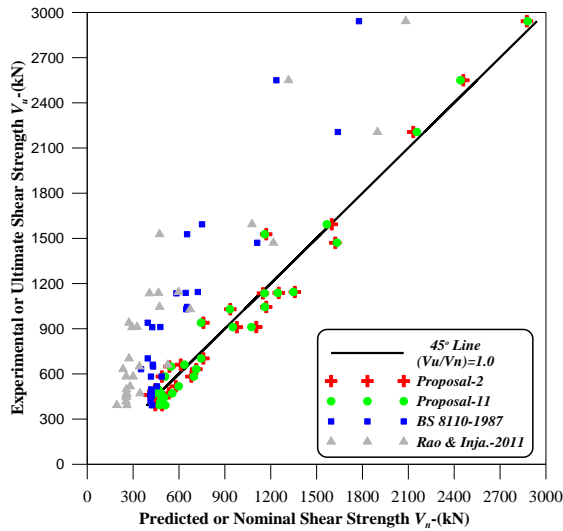
For detailed comparison between the proposed equations and the existing equations, only equations of Proposal 2 and proposal 11 are selected for this purpose, as they have the minimum values error (MAE) and (RMSE) with maximum values for coefficient of multiple determinations ( $R^2$ ). These results illustrate the accurate convergence between test results and analytical results when using these two equations where all ratios are generally close to unity for all pile caps. Finally, the empirical equation of proposal 2 and proposal 11 can be used to predict the nominal shear strength ( $V_u = V_n$ ).

### 9. Comparison between Proposed and Existing Equations- $V_n$

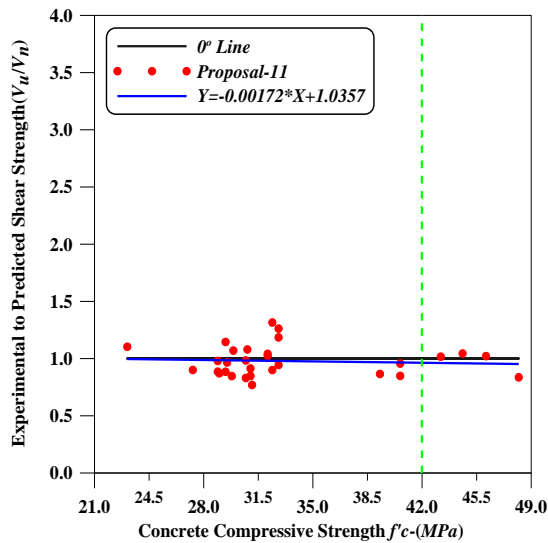
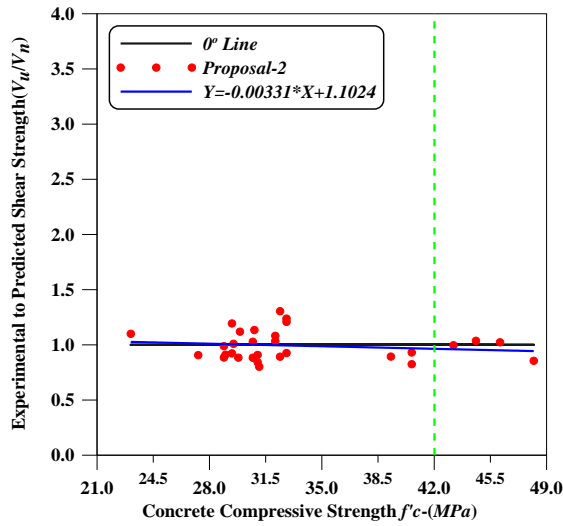
Figure (11) shows comparison between experimental and predicted nominal shear strength  $V_n$  for existing and proposed empirical equations. This figure shows the acceptable correlation between the experimental and theoretical results when using the proposed equations. Figure (11) also shows the discrepancy of existing equations by BS 8110-97 [11] and Rao & Injaganeri, 2011 [5], where the data points of the existing equations are dispersed, while the data points of the proposed equations are convergent among themselves and close to the 45° line (i.e.  $V_u=V_n$ ).

Figure (12) shows the ratio of experimental to predicted ultimate shear strengths ( $V_u / V_n$ ) versus concrete compressive strength  $f'_c$ . For the two proposed equations, the relative shear strength values are convergent for all values of  $f'_c$ .

And the fit lines of results of these two equations with a slope equal to (-0.331%) for proposal 2 equation and a slope equal to (-0.172%) for proposal 11 equation. Figure (12) also, shows that the two proposed equations are valid for all different values of concrete compressive strength even for ( $f'_c \geq 42$ MPa); they give relative shear strength close to unity.

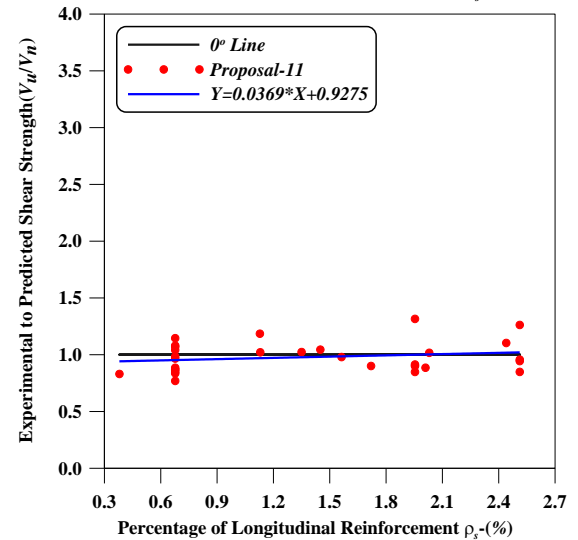
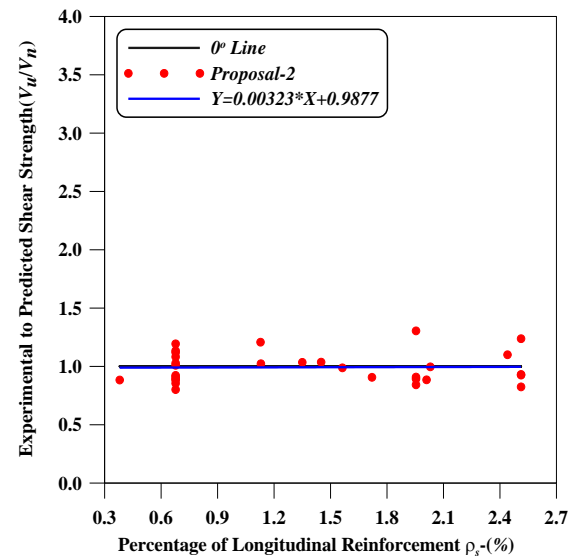


**Figure 11:** Comparison between Experimental  $V_u$  and Predicted  $V_n$  Shear Strength



**Figure 12:** Concrete Compressive Strength  $f_c$  versus Ratio of Experimental to Predicted Shear Strengths- $(V_u/V_n)$

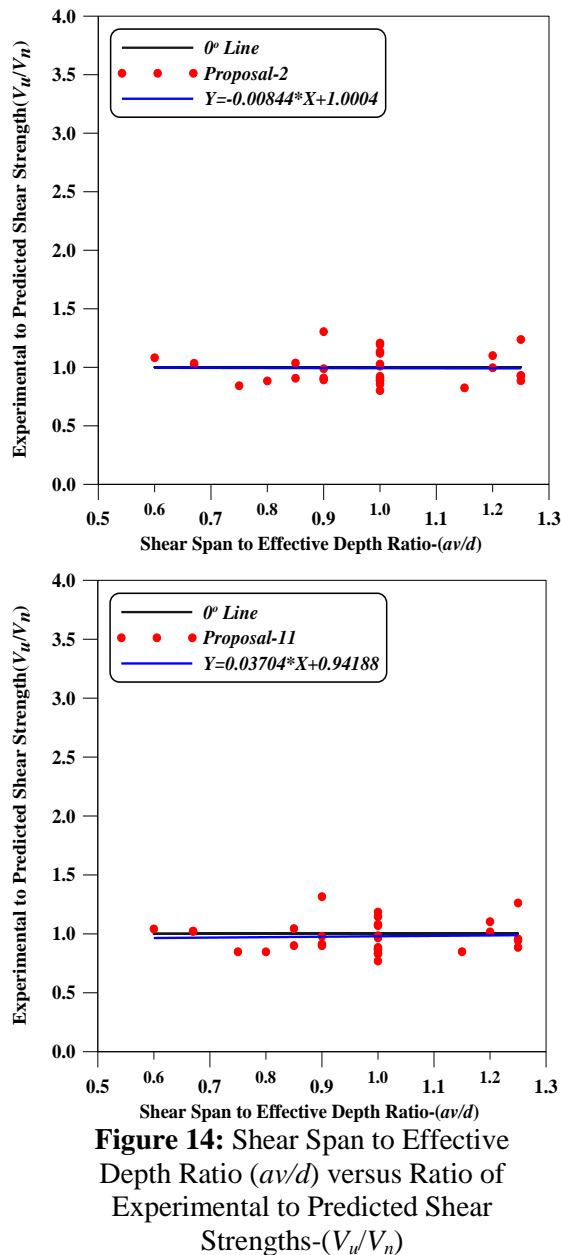
Figure (13) shows the ratio of experimental to predicted shear strengths ( $V_u / V_n$ ) versus percentage of longitudinal flexural reinforcement  $\rho_s$ . For the two proposed equations, the relative shear strength values are very close to the experimental results for all values of  $\rho_s$  and the fit lines of results of these equations are with small slope equal to (+0.332%) for proposal 2 equation and slope equal to (+3.69%) for proposal 11 equation. This means that conservatism of these equations is significantly decreased with increasing  $\rho_s$  or being more underestimating when  $\rho_s$  is less.



**Figure 13:** Percentage of Longitudinal Reinforcement  $\rho_s$  versus Ratio of Experimental to Predicted Shear Strengths- $(V_u/V_n)$

Figure (14) shows the ratio of experimental to predicted shear strengths ( $V_u / V_n$ ) versus  $(av/d)$  ratio. For the two proposed equations, the relative shear strength decreases with increasing  $(av/d)$  ratio for proposal 2 with slope (-0.844%) and increases with increasing  $(av/d)$  ratio for proposal

11 with slope (+3.704%). Also, the fit lines and data points of the proposed equations results converge to unity (i.e. zero line slope) in comparison with data points of existing equations.



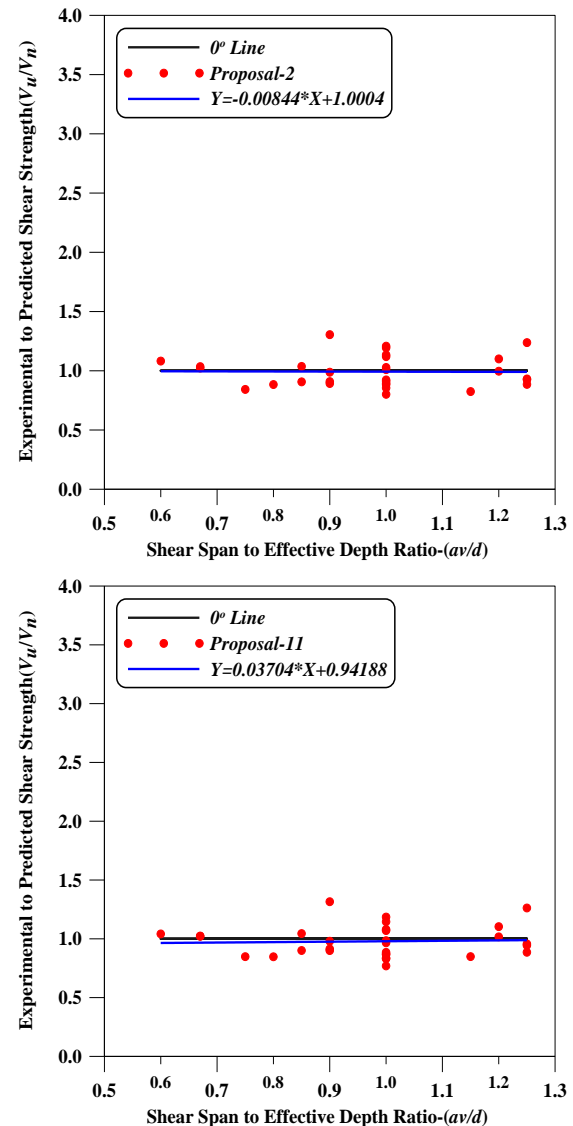
**Figure 14:** Shear Span to Effective Depth Ratio ( $av/d$ ) versus Ratio of Experimental to Predicted Shear Strengths- $(V_u/V_n)$

Figure (15) shows the ratio of experimental to predicted shear strengths ( $V_u/V_n$ ) versus effective depth  $d$ . For the two proposed equations, the relative ultimate shear strength values are convergent for all values of  $d$  and the fit lines of results obtained using these two equations are very close to unity line, as they have very small slopes of (+12\*10<sup>-3</sup>%) for proposal 2 and (+9.175\*10<sup>-3</sup>%) for proposal 11.

Figure (16) shows the ratio of experimental to predicted shear strengths ( $V_u/V_n$ ) versus transverse dimensions ratio between pile and cap ( $lb/bw$ ). The transverse dimensions ratio between pile and cap ( $lb/bw$ ) is not included in all existing empirical equations. The bearing area usually

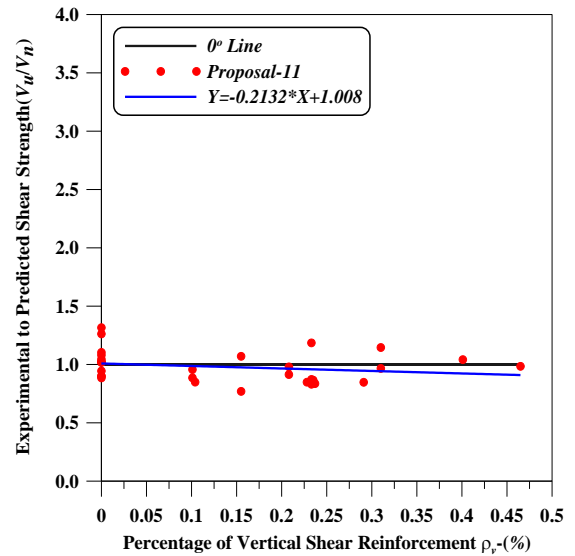
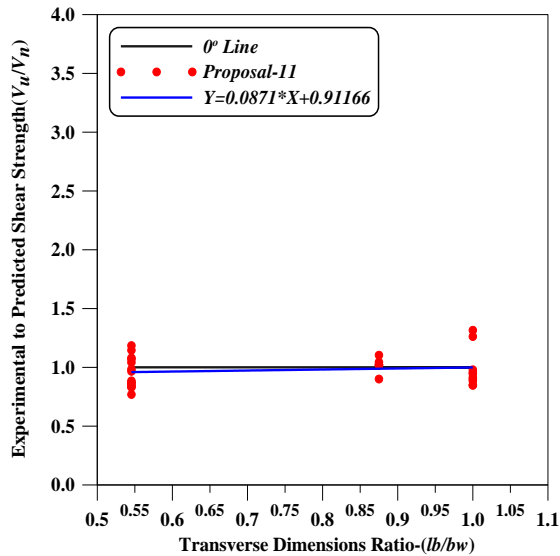
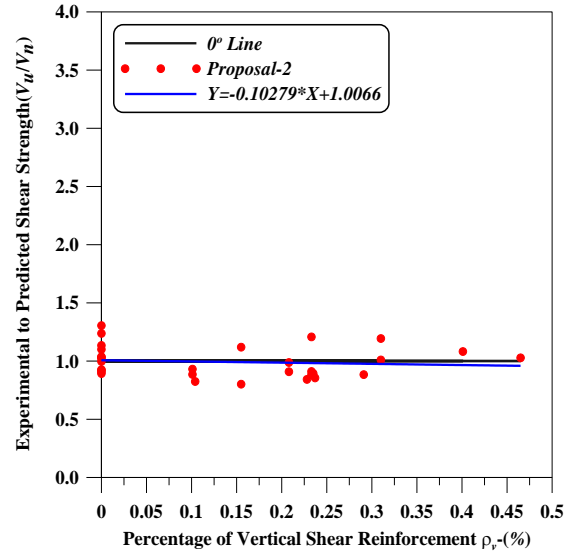
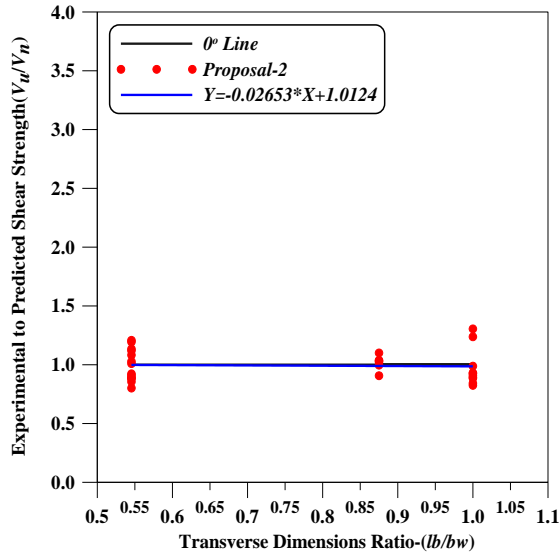
does not extend over the full thickness of the pile cap (i.e.  $lb \leq bw$ ), therefore it is used in this research work as a reduction parameter.

Now, for the two proposed equations, the relative ultimate shear strength decreases with increasing ( $lb/bw$ ) ratio for proposal 2 with slope (-2.65%) and increases with increasing ( $lb/bw$ ) ratio for proposal 11 with slope (+8.71%). Also, the fit lines and data points of results of the proposed equations are very close to unity line.



**Figure 15:** Effective Depth  $d$  versus Ratio of Experimental to Predicted Shear Strengths- $(V_u/V_n)$

Figure (17) shows the ratio of experimental to predicted shear strengths ( $V_u/V_n$ ) versus transverse vertical shear reinforcement  $\rho_v$ . For the two proposed equations, the relative ultimate shear strength decreases with increasing  $\rho_v$  for proposal 2 with slope (-10.28%) and for proposal 11 with slope (-21.32%). Also, the fit lines and data points of results of the proposed equations are close to unity line.



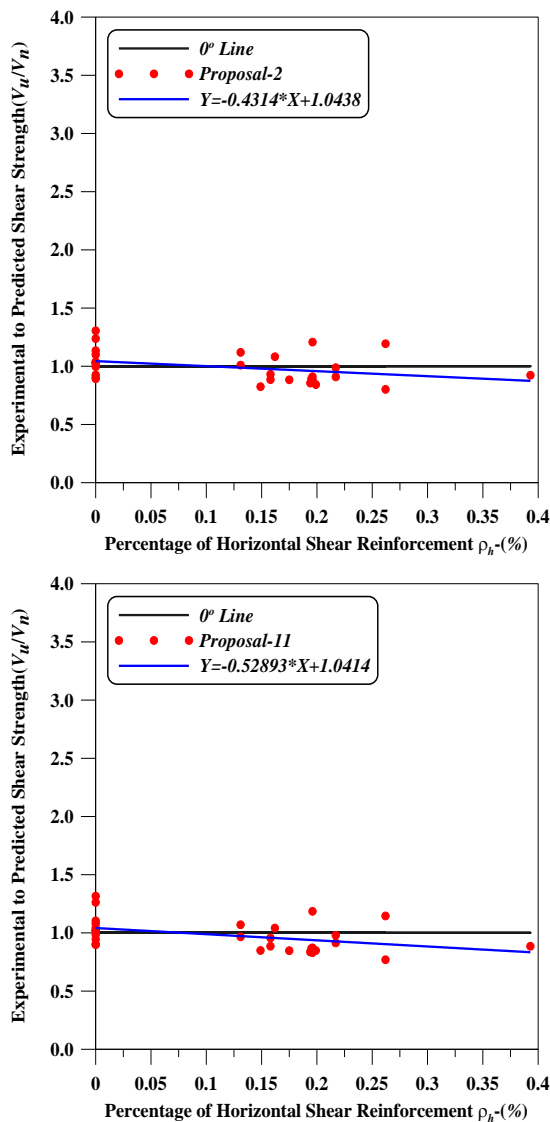
**Figure 16:** Transverse Dimensions Ratio between Pile and Cap ( $lb/bw$ ) versus Ratio of Experimental to Predicted Shear Strengths- ( $V_u/V_n$ )

**Figure 17:** Percentage of Vertical Shear Reinforcement  $\rho_v$  versus Ratio of Experimental to Predicted Shear Strengths- ( $V_u/V_n$ )

Figure (18) shows the ratio of experimental to predicted shear strengths ( $V_u / V_n$ ) versus transverse horizontal shear reinforcement  $\rho_h$ . For the two proposed equations, the relative ultimate shear strength decreases with increasing  $\rho_h$  for proposal 2 with slope (-43.14%) and for proposal 11 with slope (-52.89%). Also, the fit lines and data points of results of the proposed equations are close to unity line.

### 10. Conclusions

1-All four available existing empirical equations (ACI 318M-1999 Code, CRSI-2008 Handbook, Niwa et al.,1987 and Rao & Injaganeri, 2011) have been used to predict the cracking shear strength  $V_{cr}$  of pile caps. The equations result in more safe values when compared with experimental results. The average values of ratios of experimental to the predicted cracking shear strengths are 1.11, 1.26, 1.1 and 1.15 respectively. This means that all these methods fairly underestimate the cracking shear strength  $V_{cr}$  if they are used to analyze of pile caps.



**Figure 18:** Percentage of Horizontal Shear Reinforcement  $\rho_h$  versus Ratio of Experimental to Predicted Shear Strengths- ( $V_u/V_n$ )

2-For the present work, twelve equations are proposed to predict the diagonal cracking shear strength  $V_{cr}$  based on nonlinear regression analysis of experimental data which include the variables that affect the diagonal cracking shear strength. The two selected proposals (proposal 1 and proposal 3) are the best among the twelve proposed equations and give accurate convergence when compared with the existing equations. These two proposals give minimum values of (*MAE*) of about 26.14 and 25.9 and minimum values of (*RMSE*) of about 33.409 and 33.593. While they give maximum values for coefficient of multiple determinations ( $R^2$ ) by about 0.98 for both of them. The two proposals give consistent results with variation of all considered variables. This conclusion confirms the accuracy and rationality of these proposals.

3-Four available existing empirical equations (ACI 318M-99, ACI 318M-11, BS 8110-97 Codes and Rao & Injaganeri, 2011) are used to predict the ultimate shear strength  $V_u$ . The average values of ratios of experimental to the predicted ultimate shear strengths are 3.1, 2.03, 1.84 and 1.52 respectively. This means that all these methods fairly underestimate the ultimate shear strength  $V_u$  if they are used to analyze pile caps.

4-For the present work, twelve equations have been proposed to predict the ultimate shear strength  $V_u$  based on nonlinear regression analysis of experimental data which include the variables that affect the ultimate shear strength  $V_u$ . It was found that all these proposed equations are reasonably accurate when compared with the available existing equations. The two selected proposals (proposal 2 and proposal 11) are the best among the twelve proposed equations and result in accurate convergence when compared with the existing equations. The selected two proposals give minimum values of (*MAE*) in the range between 90.57 to 91.21 and minimum values of (*RMSE*) varying from 115.32 to 116.05. While they give maximum values for coefficient of multiple determinations ( $R^2$ ) of about 0.97 for both of them. The two proposals give consistent results with the variation of all considered variables. This conclusion confirms the accuracy and rationality of these proposals.

### 11. References

- [1] Abdul-Hameed, S., D., "Experimental and Analytical Investigation for Strength Prediction of Reinforced Concrete Pile Caps Using Strut-and-Tie Model Technique", Ph.D. Thesis, Civil Engineering Department, Al-Nahrain University, Baghdad, April 2015, pp. 91-136.
- [2] Blevot, J., and Fremy, R., "Semelles sur Pieux", Annales de l'Institut Technique du Batiment et des Travaux Puplics, Vol. 20, No. 230, pp.223-295, 1967.
- [3] Delalibera, R. G., and Giongo, J. S., "Deformation in The Strut of Two Pile Caps", IBRACON STRUCTURES AND MATERIAL JOURNAL, Vol. (1), Number (2), June 2008, pp. 121-157.
- [4] *CRSI Handbook*, Concrete Reinforcing Steel Institute, Chicago, 2008.
- [5] Rao, G., A., and Injaganeri, S., S., "Evaluation of Size Dependent Design Shear Strength of Reinforced Concrete Beams without Web Reinforcement", Sadhana, © Indian Academy of Sciences, Vol. 36, Part 3, June 2011, pp. 393-410.
- [6] ACI Committee 318 "Building Code Requirements for Structural Concrete (ACI

- 318)", American Concrete Institute, Detroit, USA, 1999.
- [7] Niwa, J., Yamada, K., Yokozawa, K., and Okamura, H., "Revaluation of the Equation for Shear Strength of Reinforced Concrete Beams without Web Reinforcement", Concrete Library of JSCE, 9, 1987, pp. 65-84.
- [8] "Data Fit Manual", Version (14)-Evaluation Copy, USA, 2014.
- [9] Kennedy, J., B., and Neville, A., M., "Basic Statistical Method for Engineering and Scientists", Harper & Row Publisher, New York, third Edition, 1986.
- [10] ACI Committee 318 "Building Code Requirements for Structural Concrete (ACI 318M)", American Concrete Institute, Detroit, USA, 2011.
- [11] British Standards Institution, "Structural Use of Concrete: BS 8110: Part1", Milton Keynes, UK, 1997.
- [12] 12-ACI Committee 318 "Building Code Requirements for Structural Concrete (ACI 318M)", American Concrete Institute, Detroit, USA, 2002.

## ايجاد مقاومة القص لقبعات الركائز ذات الركينتين باستخدام المعادلات الوضعية

د.صفاء ضياء عبدالحميد النعيمي

وزارة الاعمار والاسكان

safaa\_n1973@yahoo.com

د.احسان علي صائب الشعرباف

جامعة النهريين/كلية الهندسة

ishaarba@yahoo.com

د.رياض جواد عزيز الموسوي

جامعة النهريين/كلية الهندسة

riyadhaziz48@yahoo.com

### الخلاصة:

تتضمن هذه الدراسة تحليلاً لقبعات الركائز ذات الركينتين بالإضافة الى تحليل قبعات ركائز اخرى مفحوصة ومتوفرة في ادبيات البحوث السابقة. تم اقتراح اثنا عشر علاقة وضعية لاجاد مقاومة تشقق القص القطري ومقاومة القص القصوى على حده و باستخدام طريقة التحليل الارتدادي المتعدد اللاخطيه للبيانات العملية. استخلصت علاقته في هذا البحث تخص التنبؤ بمقدار مقاومة تشقق القص القطري ومقاومة القص القصوى كلاً على حده حيث تم الحصول على توافق جيد عند المقارنة مع النتائج العملية باستخدام هاتين العلاقتين حيث اظهرت المعادلات المقترحة اقل نسبة من مقاييس الخطأ (Mean Absolute Error-MAE) و (Root Mean Square Error-RMSE) وحققت دقة عالية من حيث تكوين منحني العلاقة (Coefficient of Multiple R<sup>2</sup>) (Determinations-). تم مقارنة نتائج العلاقات المقترحة لاجاد مقاومة تشقق القص القطري مع المعادلات المتوفرة والمطورة سابقاً من قبل باحثين اخرين (Niwa et al., 1987) و (Rao & Injaganeri, 2011). وتبين عملية تحليل قبعات الركائز باستخدام المعادلات المقترحة في هذا البحث دقة في النتائج عند مقارنتها مع نتائج الفحوصات المختبرية ونتائج المعادلات المتوفرة. اما بالنسبة للتنبؤ بمقاومة القص القصوى فقد تم اقتراح علاقتين واجريت مقارنة للنتائج المستخلصة مع نتائج المعادلات المتوفرة والمطورة من قبل (BS 8110-1997) و (Rao & Injaganeri, 2011). وقد تبين من خلال التحليل باستخدام المعادلات المقترحة وجود توافق مقبول مع النتائج العملية مقارنة بنتائج المعادلات المتوفرة.