

## Iraqi Cars License Plate Detection and Recognition System using Edge Detection and Template Matching Correlation

**Dr. Eyad I. Abbas**

Department of Electrical Engineering, University of Technology, Baghdad.

Email: eyad\_electdep@yahoo.com

**Thaer A. Hashim**

Department of Electrical Engineering, University of Technology, Baghdad.

Email: thaer.ahay@yahoo.com

Received on: 30/9/2014 & Accepted on: 2/4/2015

### ABSTRACT:

Automatic License Plate Detection and Recognition (ALPDR) system is an image processing technology used to identify cars by their license plates. This system consists of two main parts: the first is a practical implementation of how to take an automatically snapshot for cars passes, this was done by two sensors type (GP2Y0A21YK0F sensor) connected with each other and interfaced with a A4tech USB camera, and this camera is interfaced using Matlab 2013a with the personal computer. The second part is image processing, this part includes four basic stages: The first stage is image preprocessing which involves image normalization and RGB to gray image conversion. Second stage is detection of a possible license plate using edge detection technique and extracts these LP using region growing technique, detection rates reach to 95%. Third stage is alphanumeric character segmentation to isolate each character, numbers and words of the license plate using Otsu's and Hough transforms technique for subsequent recognition. The last stage reads the alphanumeric character and words by correlation template matching, which is a simple, fast and given a recognition rate reach to 98.245%.

**Keywords:** Template Matching Correlation, Edge detection, Morphological operations, Otsu's and Hough transforms.

### نظام تحري وتمييز لوحة الرخصة للسيارات العراقية باستخدام تقنية كشف الحافات والمطابقة القالبية

الخلاصة:

نظام تحري و تمييز لوحات ارقام السيارات هو تقنية في معالجة الصور يستخدم للتعرف على السيارات من خلال لوحات الارقم الخاصة بها. بني النظام على قسمين رئيسيين: القسم الاول التنفيذ العملي وهو كيفية التقاط صورة للسيارات المارة اوتوماتيكيا وتم هذا عن طريق متحسين نوع (GP2Y0A21YK0F sensor) تربط مع بعضها وتوصل إلى الكاميرا (A4tech USB camera) المتصلة بالكمبيوتر. تعمل الكاميرا اوتوماتيكيا بواسطة برنامج Matlab من حيث تخزين الصور الملتقطة ومعالجتها وكذلك تخزين النتائج ما بعد المعالجة في ملف خاص مهيب لهذه العملية. القسم الثاني معالجة الصورة ويتضمن خمسة مراحل أساسية: المرحلة الاولى هي مرحلة ما قبل المعالجة وتتضمن تجزئة او تغيير حجم الصورة الملتقطة ومن ثم تحويلها للنظام الرمادي. المرحلة الثانية وتتضمن كشف لوحة الرخصة باستخدام تقنية كشف الحافات لاستخراج المعلومات من الصورة ومن ثم استخراج اللوحة باستخدام تقنية تنمية المساحة وقد حققت هذه المرحلة نسبة كشف 95%. المرحلة الثالثة هي تجزئة واستخراج المعلومات من اللوحة, حيث تم عزل كل رقم وكل حرف وكل كلمة باستخدام تقنيتي (Otsu' and Hough transforms) على حده لغرض التمييز. المرحلة الاخيرة هي تمييز الارقام والحروف والكلمات الموجودة في اللوحة باستخدام تقنية المطابقة القالبية وتخزينها في ملف خاص, وهي تقنية بسيطة وسريعة في التمييز وقد أعطت ومن خلال التجربة نسبة تمييز 98.245%.

## INTRODUCTION:

Cars in each country have a unique license number, which is written on its license plate. This number distinguishes one car from the other, which is useful especially when both are of same make and model [1]. An automated system can be implemented to identify the license plate of a car and extract the numbers and characters from the region containing a license plate [2]. License Plate Detection Recognition (LPDR) is a form of automatic car identification. It is an image processing technology used to identify vehicles by their license plates only [3, 4]. There are many methods were proposed for the LP recognition for example: template matching [5], neural network [1], essential elements based method [6] and optical character recognition [7]. ALPDR have a number of different useful applications such as: tolling, traffic control, border control, access control, detection of stolen cars, car park entrance or any statistical research [7, 8].

### ALPDR System Model:

The overall ALPDR system can be subdivided into the software and hardware model:

#### Software Model:

The main and the most important portion of this system is the software model. The software model use series of image processing techniques which are implemented in MATLAB R2013a. The ALPDR algorithm is broadly divided into three following steps:

#### Capture image:

The first step is the capturing of an image using a camera type (**A4tech USB camera**) connected to the PC. The images are captured in RGB format so it can be further process for the number plate extraction.

#### Detecting and extracting the plate region:

It is the process of localizing the plate region from the whole image. It involves several digital image processing concepts such as noise filtering, component analysis, color conversion, segmentation and others. Plate localization strategies that involve smaller computational resources for the purpose of producing fastest algorithm are an active research area to achieve real time performance [4]. This is because the recognition accuracy is directly influenced by the localization result.

#### Alphanumeric Characters and words recognition:

After the license plate region is extracted, the individual characters, numbers a on the license plate should be extracted and recognized. The main processing in this stage is finding and recognizing characters, numbers and words on the license plate.

#### Hardware Model:

The hardware model consists of two sensors type **GP2Y0A21YK0F**. This sensors are connected together and used to sense the presence of a car, camera to capture the image and PC on which algorithm is executed.

#### The proposed algorithm:

#### Car detection and image Acquisition:

The first stage of ALPDR system is car detection and image acquisition. This stage was done by two IR sensors **GP2Y0A21YK0F** transceiver model connected together using electronic circuit to sense the presence of car, the output of these sensors are connected to A4tech USB camera for capture image of the car. This camera connected to the PC through USB port and saved the pictures in a special folder. Figure (1) shows the block diagram of the proposed hardware system model.

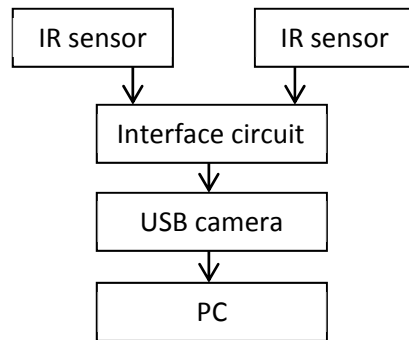

Figure (1): Block diagram of proposed hardware system model.

IR sensor GP2Y0A21YK0F transceiver module is a distance measuring sensor unit, composed of an integrated combination of PSD (position sensitive detector), IRED (infrared emitting diode) and signal processing circuit. The block diagram of this sensor is shown in figure (2).

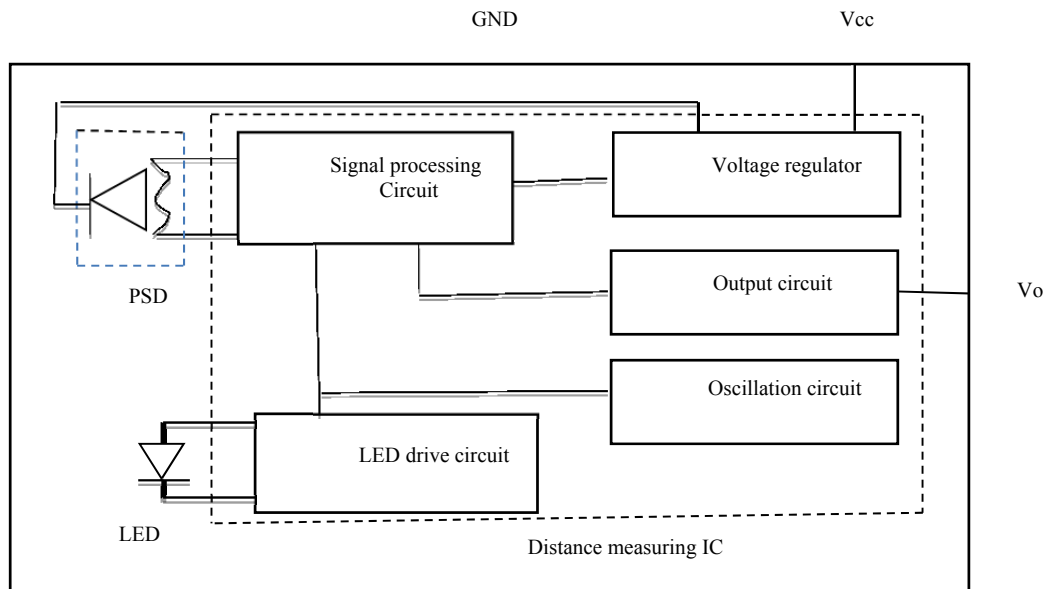

Figure (2): Block diagram of GP2Y0A21YK0F sensor.

This device outputs the voltage corresponding to the detection distance. The distances measuring of this device are (10cm to 80cm). The maximum output voltage of this device is 0.55V at 10cm distance, and minimum voltage is 0.25V at 80cm distance. Figure (3) shows the interface circuit between two IR sensors and camera.

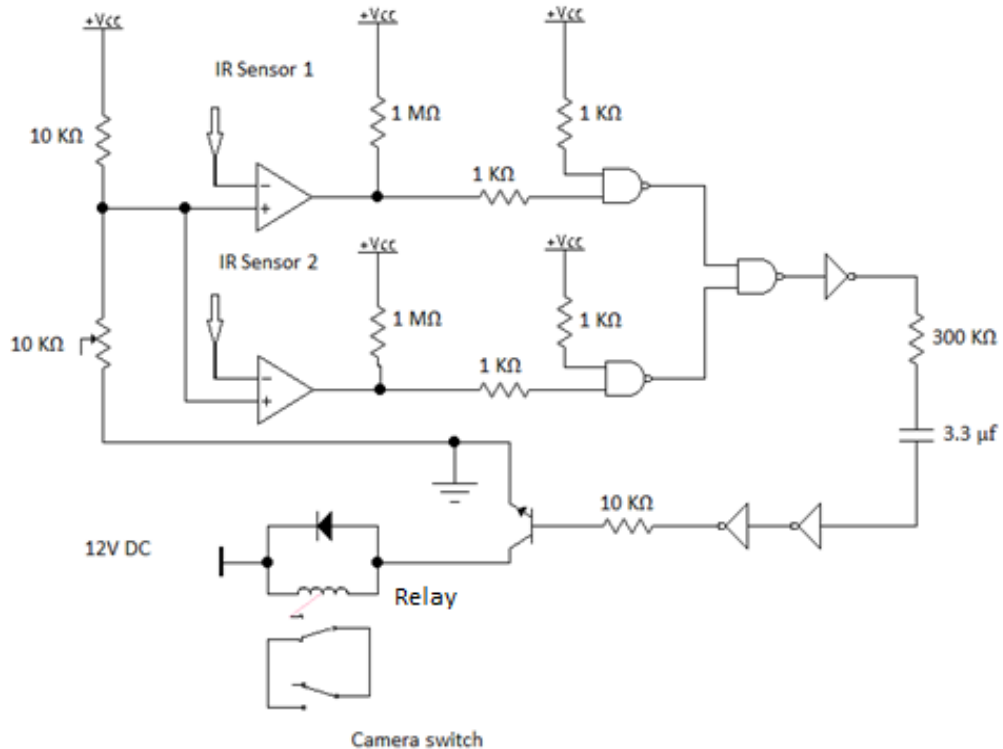

Figure (3): Interface circuit between two IR sensors and camera.

Two IR sensors are placed beside or entrance with 2m is the distance between them. When the cars pass through the signals of two IR sensors, the sensors will transmit the signal to the relay, the contacts of this relay are connected to the switch of the camera, and this camera will capture the image of the car. The time of capturing image is 1ms which selected by 3.3μf capacitance and 300 kΩ resistance. A4tech camera is a USB camera has different resolution and format. In the proposed system, the resolution of capturing image to 3200\*2400 pixels and jpg format was set. This camera is placed in front of the car at different distances. The captured image is saved in special folder called (buffer folder).

A special program was written using a MATLAB R2031a language. This program used to move the image which is saved in buffer folder to the main program which use for image processing and save the input image and results in special folder called (saved folder). The completed hardware system design is shown in figure (4).



Figure (4): Completed hardware system design.

**Image Preprocessing:**

Image preprocessing stage is necessary to prepare the image for further processing; this stage includes the following steps:

**Image Normalization:**

The input image is loaded into the program which has different size and resolution depending on the system hardware that used for acquisition. To reduce processing time and complex recognition procedure, the size of the image is decreased. This system is resizing any input image to fixed 1000\*1000 pixels automatically. MATLAB R2013a inbuilt function (**Imresize**) is used to resize the input image into a fixed resolution.

**RGB to Gray Image Conversion:**

The input image of the car is captured by a digital camera is colorful image or RGB image as shown in figure (5-a). In order to facilitate the plate detection and extraction, increase the processing speed; it must be convert RGB image to gray scale (intensity) image, as shown in figure (5-b). Color image (RGB) acquired by a digital camera is converted to gray scale image based on the RGB to gray scale conversion technique. In this phase, the MATLAB function `rgb2gray` is used. It converts the true color (RGB) image to intensity image using equation (1):

$$\text{Gray image} = (0.2989 R) + (0.5870 G) + (0.1140 B) \quad \dots (1)$$

Where: R, G and B are the red, green and blue color components.



(a)



(b)

**Figure (5): (a) Input RGB image and (b) Gray Image.**

**Car Plate Detection and Extraction:**

This stage includes all the necessary steps which are used to find the accurate license plate from the captured image, and make all the necessary adjustments on that license plate.

**Image Dilation:**

Dilation is a technique of improving the given image by sharpens the edges of objects in an image, filling the holes in an image, join the broken lines and increase the image brightness. The noise within an image can also be removed using dilation technique. By making the edges sharper, the difference of gray value between neighboring pixels at the edge of an object can be increased. This enhances the edge detection.

The dilation of image X by the structuring element B is defined by: [9]

$$X \oplus B = \{x | B_x^2 \subset X\} \quad \dots (2)$$

The process of dilation will help to nullify such losses. Figure (6) shows the image after dilation process.



**Figure (6): Image dilated.**

**Image Histogram and Edge Processing:**

Horizontal and Vertical histogram was used at this stage, which represents the row wise and column wise histogram respectively. These histograms represent the sum of differences of gray values between neighboring pixels of an image, row wise and column wise. Firstly, the horizontal histogram is calculated. So, in order to find the horizontal histogram, the algorithm traverses through each column of an image. The algorithm starts with the second pixel from the top for each column. The difference between second and first pixel is calculated. If the difference exceeds certain threshold, it is added to the total sum of differences. Then, algorithm will move downwards to calculate the difference between the third and second pixels and so on until the end of the column and calculate the total sum of differences between neighboring pixels. At the end, an array containing the column wise sum is created. In order to find the vertical histogram, the same process is used for horizontal histogram. But in this case, rows are processed instead of columns. Figure (7) shows the histogram processing for horizontal vertical edge.

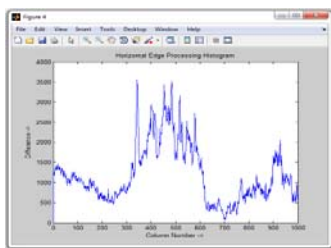

(a) Horizontal.

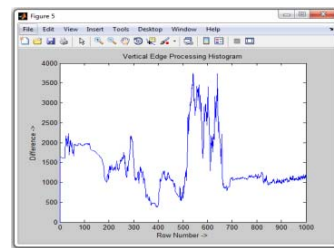

(b) Vertical.

**Figure (7): Horizontal and vertical edge processing histogram.**

Referring to the above figures the histogram values are changed dramatically between the consecutive rows and columns. Therefore, to prevent the losses of important information in the next steps, the drastic changes in the value of a histogram must be smooth. To solve this problem the histogram is passed through low pass digital filter with the dynamic threshold is equal to the average value of a histogram. Both horizontal and vertical histograms are passed through a filter with this dynamic threshold. While performing this step, each histogram value is averaged out considering the values on it right hand side and left hand side. Figure (8) shows the horizontal and vertical histograms after passing through a low pass digital filter.

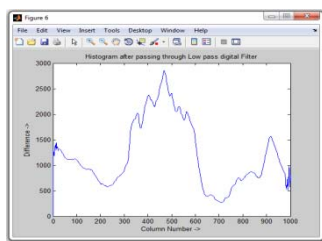

(a) Horizontal edge processing.

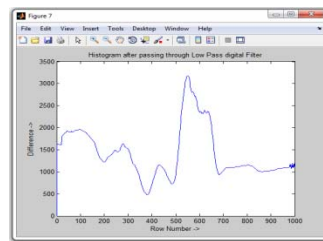

(b) Vertical edge processing.

**Figure (8): Histogram after passing through low pass digital filter.**

**Sobel Edge Detection:**

After converted the image into gray scale and smoothed it using a histogram and low pass digital filter, a Sobel edge detection algorithm was used to find the edges of an image using the Sobel approximation to the derivative [10]. It produces the edges at those points where the gradient of an image is the maximum. This algorithm gives the optimal edge detector with very low error rate. Figure (9) shows the image after effect the Sobel edge detection.

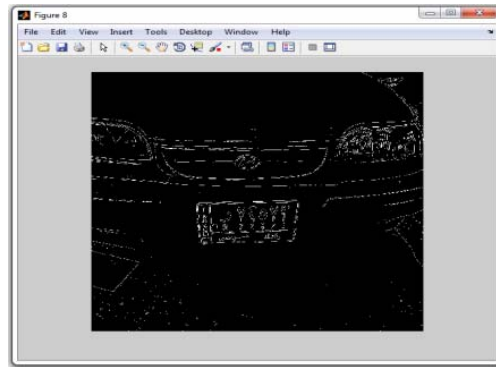
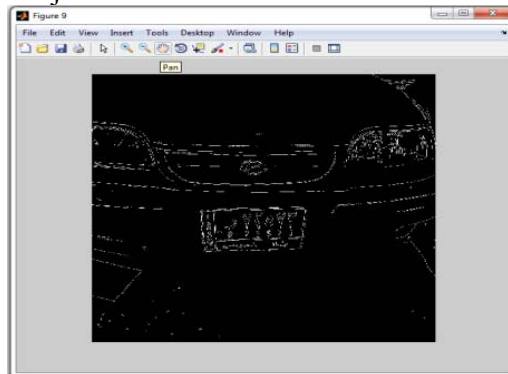

**Figure (9): Image after Sobel edge detection.**

#### **Filtering Unwanted Pixels:**

Figure (9) shown many unwanted small objects or connected components and the noise parts in the image such as screws and nuts and small dust particles, which may give the false license plate detection stage. To overcome this problem, the noise must remove after edge detection. It can remove this noise from the image by checking 8-connectivity of each pixel. A 3\*3 matrix is taken, this matrix traversing through all pixels in the image and remove the noise using BWAREAOPEN algorithm. Figure (10) shows the image after removed isolated components. The following steps have been used to remove the isolated pixels using BWAREAOPEN algorithm.

- Determine the connected components.
- Compute the area of each component.
- Removes the small objects.



**Figure (10): Image after removed isolated components.**

#### **Region Growing of LP:**

The basic purpose of this stage is to fill the holes that may be found in the LP segment [11]. Holes are a set of background pixels that cannot be reached by filling in the background from the edge of gray scale image. For filling the holes in image the flood fill operation was used. IMFILL (BW, 'holes') function which provided by MATLAB R2013a toolbox function that fills the holes in the binarized image called (BW). This function will perform the flood fill process on the binary and grayscale images. Flood fills operation change the pixels of background (zeros) to pixels of foreground (once) for the binary image, those pixels are on the middle of the foreground so they have to be filling with one. In the gray scale image, the process will fill up the holes by bringing the area of dark pixel to the surrounding brighter pixels. Figure (11) shows the gray scale image after fill the holes.

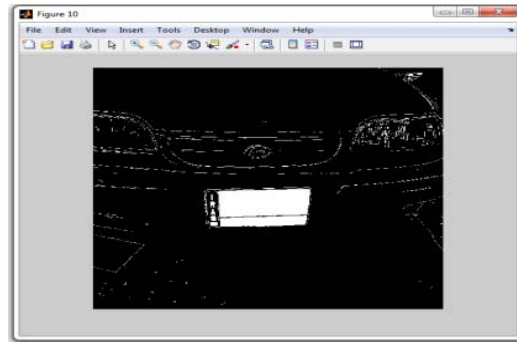

Figure (11): Image after fill the holes.

**Region of Interest Extraction:**

In order to find the ROI to extract the license plate from the image after region growing process connected components analysis [12] algorithm was used. Connected component algorithm used to find the regions of connected pixels which have the same value. This algorithm is done by calculated the first connectivity of each pixel and then removed the unwanted edges depended on the connectivity checking. BWEREAOPEN function which provided by MATLAB R2013a toolbox function that used to specifies the desired connectivity. So, all components having number of pixel lower than threshold value are removed to get the actual location of the number plate. Threshold value is chosen depended on the license plate size. The license plate detected is shown in figure (12).

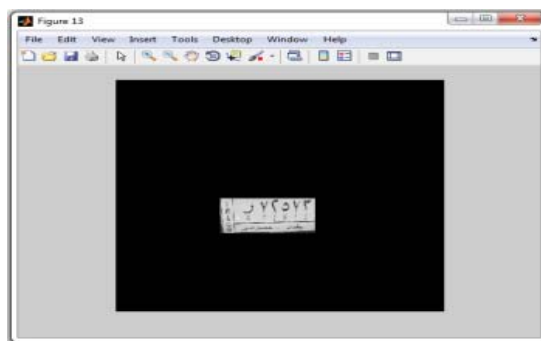

Figure (12): Detected license plate.

**Cutting the license Plate area:**

This step is very necessary because of the next stage called alphanumeric character and word segmentation will be depending on it. So, any error in this step will be effect on the segmentation process. The area is cropped from the image after identifying the best possible component for the license plate with the help of coordinate of the chosen connected component and sent it to the character segmentation stage. Figure (13) shows the output location plate after cropping. This step is done using IMCROP function which provided by MATLAB R2013a.



Figure (13): Output location plate.



**Alphanumeric Character and Word Segmentation:**

Alphanumeric characters and words segmentation is a procedure of extracting the numbers, characters and words from the license plate image. Diverse aspects make the character segmentation task complicated, like, plate frame, image noise, space mark, plate's rotation and light variance. A proposed method of this stage illustrated in the following steps:

**Binarization of the license plate:**

In order to segment the numbers, characters and words of the license plate image which extracted from car plate detection and extraction stage, it should convert the license plate to the binary level. For binarization the license plate a threshold value is required. Otsu algorithm is used to select the threshold value [13]. These algorithms select the optimal thresholding depending on the intensity level of each license plate image. So, if the value of the pixels in the license plate image is less than the threshold value, it is expressed as "1"; and if it is greater than the threshold value, it is expressed as "0". In this way, the image license plate is converted into the binary level. Figure (14) shows the license plate image after converted into the binary level.



Figure (14): Binary license plate image.

**Skew Correction and Removal impurities:**

In this system the license plate region was divided into two parts; first part contains the number of the license plate and a single character written in Arabic which appears in the top of the license plate. Second part contains a word referring to the class of the car and province name. Each parts of the license plate region may be skewed by rotating the extracted binary license plate image by an angle equal to orientation angle of the region but in opposite direction to increasing the accuracy of segmentation process. The impurities such as the regions belonging to plate, fixing blots, boundary areas pose a problem for the accuracy of the system and hence they must be removed. Figure (15) shows the license plate after divided, skew correction and removed impurities.

Removal of those impurities was done by the following steps:

1. Calculating the region of each number, character and word and labeling by connected component labeling.
2. Find out number of pixel in each label.
3. Apply morphological operations to smoothing the numbers, characters and words.
4. Apply Otsu's algorithm to find the optimal threshold for each number, character and word. So, any impurities larger and smaller than the measurements of the number, character and word through the characteristics of each region will be removed depending on this threshold.

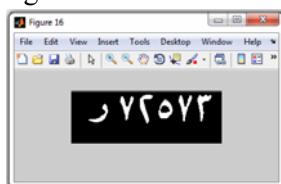

(a) First part.

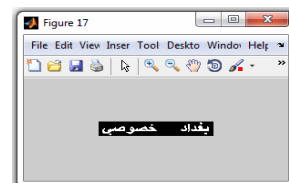

(b) Second part.

Figure (15): Two parts after extracted, skew correction and removed impurities.

**Hough Transform:**

Hough transform algorithm was used to extraction each individual character, number and word respectively. Hough transform produces a list of lines in the form of accumulator cells [14]. In Hough transform algorithm, the first step is reading the two parts of the binary images as input, and then passed these images through two parallel processes vertical and horizontal edge detection to extract the edges. Figure (16) shows the segmented character, numbers and word.

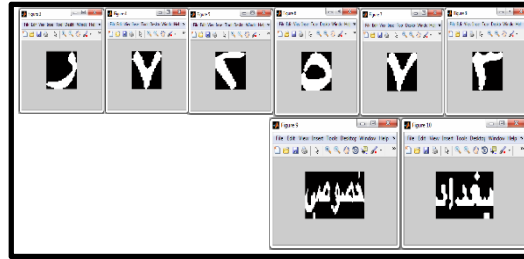

**Figure (16): Character, numbers and words segmentation.**

**Alphanumeric Character and word Recognition:**

The final stage of proposed system is recognize of each segmented characters, numbers and words that extracted from license plate. There are many techniques that used for this purpose. In this system template matching correlation technique was used for recognition process. This technique basically matches the linear relationship between the detected character, number and word image and the standard template database images of characters, numbers and words. The character, number and word identity is assigned based on the similarity value. The similarity between the input (detected) image and database image is calculated using correlation coefficient.

To increase the recognition rate and processing speed, the license plate is divided into four classes: first class for the character, second class for the numbers, third class for the provinces and last class for the car type. Figure (17) shows the template database for each class.



**Figure (17): Template database images.**

After comparing the input image with the templates, class of the character, number and word is selected. The return value of the correlation process is used to classify the character, number and word, that is, return values of the comparison approaching to '1' are assumed as good match. Finally recognized characters, numbers and words are displayed. Figure (18) shows the flowchart of template matching technique. The first segment from our LP contain on character 'ر' is compared with each contents of the first class. The maximum correlation occurs between the segmented character and the template number '3' which equal to 0.998. Due to the template number '3' has maximum correlation; the character 'R' is displayed. This process is also used for recognize the other segmented numbers and words. The recognition results are: 'R', '7', '2', '5', '7', '3', 'Baghdad', 'Khusosy'.

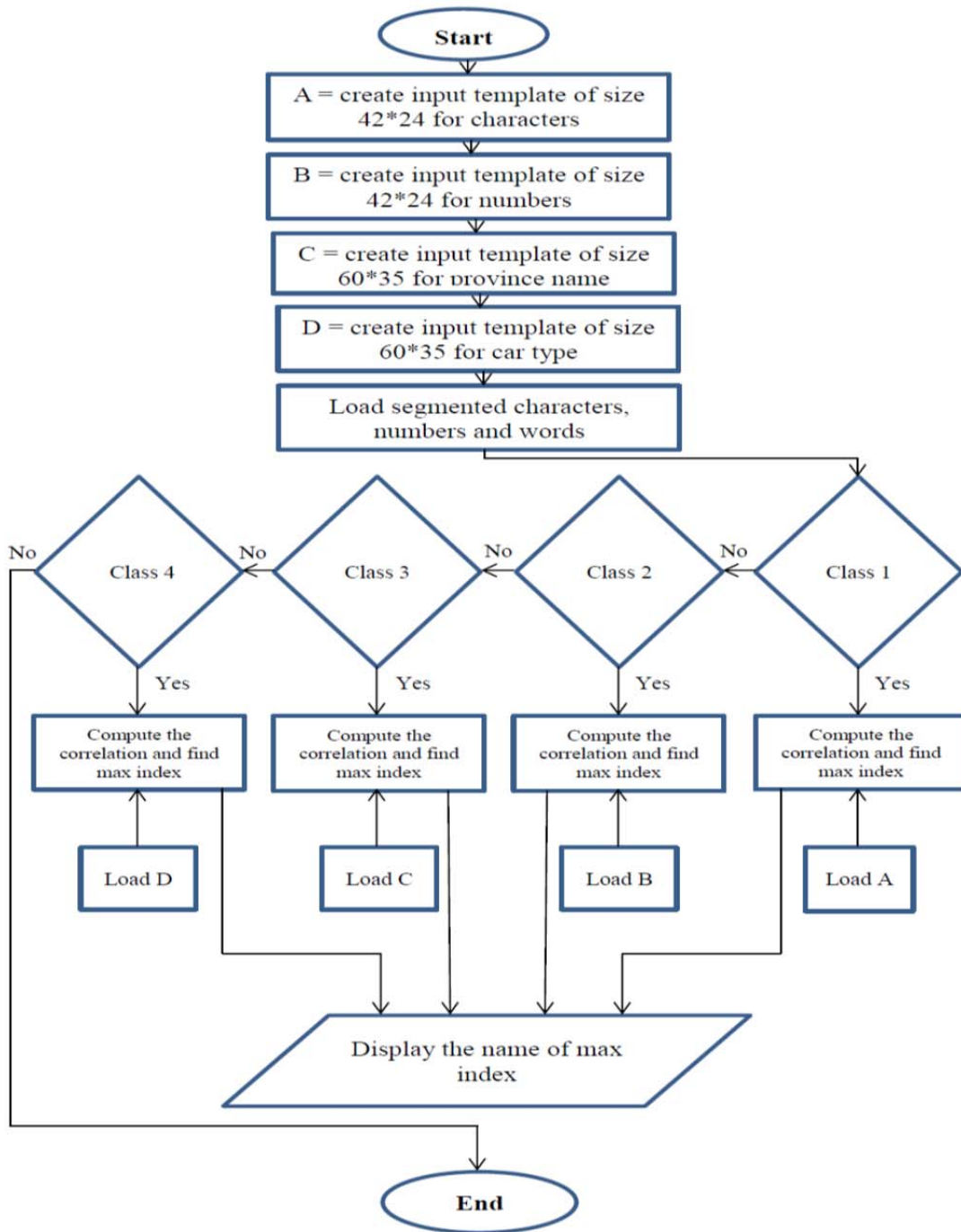

Figure (18): Flowchart of template matching technique.

**Experimental Results:**

MATLAB R2013a editor software was used to develop the program of license plate detection and recognition system. The car images snapshots have been taken automatically using A4tech USB camera. Recognition rate can be expressed by the equation (2).

$$\text{Recognition rate} = \frac{\text{Number of image correctly recognized}}{\text{Total number of the tested image}} * 100\% \quad \dots (3)$$

Table (1) Plate test results

Test Type	Number of Tests	Number of Correct Recognition	Number of Wrong Recognition	Percentage
Plate Detection	60	57	3	95%
Character Segmentation	337	337	0	100%
Character Recognition	57	56	1	98.245%

Table (2) Results of the numbers











Number	Image Template	Trial Number	Correct Recognition	False Recognition	Percentage
0		16	14	2	87.500%
1		39	38	1	97.435%
2		37	36	1	97.297%
3		17	15	2	88.235%
4		22	22	0	100%
5		32	32	0	100%
6		29	27	2	93.103%
7		25	25	0	100%
8		27	27	0	100%
9		24	22	2	91.666%

Table (3) Results of the characters











Character	Image Template	Trial Character	Correct Character	False Character	Percentage
ا		24	23	1	95.833%
ح		4	3	1	75%
خ		2	1	1	50%
د		10	9	1	90%
ر		6	6	0	100%
ط		2	1	1	50%
م		4	2	2	50%
ه		4	4	0	100%
و		2	1	1	50%
ي		2	2	0	100%

Table (4) Results of the provinces







Province	Image Template	Trail Province	Correct Province	False Province	Percentage
كربلاء		14	14	0	100%
نجف		11	11	0	100%
بغداد		26	26	0	100%
ديالى		2	2	0	100%
واسط		2	2	0	100%
القادسية		3	3	0	100%
المثنى		2	2	0	100%

Table (5) Results of the classes





Class	Image Template	Trial Class	Correct Class	False Class	Percentage
خصوصي		43	42	1	97.674%
اجرة		10	10	0	100%
حمل		7	7	0	100%

The proposed system of this research has been tested on 60 images taken automatically under different illumination conditions. The average time for LP detection is 2 second while the average time for the segmentation and recognition is 3 second. So, the total average time from capturing image to recognize the LP is 6 second. The proposed system of this work has been tested on the images was taken under different illumination so that the time of captured image at from 8:40 AM to 10:55 PM, the captured image was taken from different distances between (50 centimeters to 3 meter) and the car speed was 15km/h or less. Out of 60 images, 3 inputs/ output and their recognition for each image and time of the capturing image are shown in table (6). The proposed system comparisons with other works are shown in table (7).

Table (6) Three sample of plate detection and recognition results

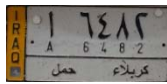
Car No.	Input Image	Output Location Plate	Character Recognition (Arabic style)	Character Recognition (English style)	Time
1				A-6482 Karbala Hemel	6/3/2014 1:09 PM
2				J-30086 Baghdad Khusosy	9/3/2014 11:52 AM
3				A-21381 Karbala Khusosy	26/5/2014 6:33 PM

Table (7) Comparison proposed scheme with other works

Methods	Techniques used	Type of LP used	Execution time for each sample (sec)	No. of samples	Recognition rate (%)
Proposed scheme	Morphological operators, Edge detection, Hough transform and Template matching.		6	60	98.245
Mohsin. A et al [2]	Edge detection and ELMAN Neural Network.		-	21	76
Zuber. H [15]	CCA, OCR and Template matching.		-	23	82.11
Kabir. H et al [16]	Property of symmetry, SAT, Artificial Neural Network (ANN)		0.16	200	89

**CONCLUSIONS:**

In detection stage the error is 5% in the examined of 60 images while in recognition stage the error is 1.755% in the examined of 57 license plate. The average time of license plate detection and recognition for each image is 6 seconds. By morphological operator with edge detection the license plate located can be detected at any corner of image. Template matching technique with correlation coefficient gives a best recognition rate with very low error rate; these algorithms solved the problems of skew, orientation and noise the segmented characters, numbers and words.

**REFERENCES**

[1] Wang. Z and Shaozi. L, "Research and Implement for Vehicle License Plate Recognition Based on improved BP Network", International Conference on Computer and Communication Technologies in Agriculture Engineering, IEEE, PP. 101-104, 2010.

[2] Mohsin. A, Hassin. A. H and Abdul Jaleel. I. Q., "An Automatic Recognizer for Iraqi License Plates Using ELMAN Neural Network", Journal of Software Engineering and Applications, SciRes, Vol.3, No. 12, PP. 1163-1166, December, 2010.

[3] Sivanandan. S, Dhanait. A, Dhepale. Y and Saiyyad. Y, "Automatic Vehicle Identification Using License Plate Recognition for Indian Vehicles", International Journal of Computer Applications, PP. 23-28, 2012.

- [4] Sarfraz. M, Ahmed. M. J and Syed. A. G, "Saudi Arabian License Plate Recognition System", International Conference on Geometric Modeling and Graphics (GMAG'03), IEEE, 2003.
- [5] Zakaria. M. F, Suandi. S. A, "Malaysian Car Number Plate Detection System Based on Template Matching and Color Information", International Journal on Computer Science and Engineering, vol.2, No.4, 2010.
- [6] Sangamuang. P, Thamnittasana. C and Kondo. T, "Thai Car License Plate Recognition Using Essential-Elements-Based Method", Asia-Pacific Conference on Communications, IEEE, PP. 41-44, 2007.
- [7] Cika. P, Zukal. M and Sebela. M, "Vehicle License Plate Detection and Recognition Using Symbol Analysis", 34th International Conference on Telecommunications and Signal Processing (TSP), IEEE, PP. 589-592, 2011.
- [8] Snehel. B. S, "Identification of Indian Vehicles by their Number Plates", International Journal of Electronics, Communication & Instrumentation Engineering Research and Development (IJECIERD), Vol. 3, PP. 81-88, Aug, 2013.
- [9] N. Jawas, N. Suciati, "Image Inpainting using Erosion and Dilation Operation", International Journal of Advanced Science and Technology, Vol. 51, PP. 127-134, February, 2013.
- [10] Nimbhorkar. S. U, Manoj. K.V, "Edge Detection of Images Using Sobel Operator", International Journal of Emerging Technology and Advanced Engineering, Vol. 2, Issue 1, PP. 291-293, January 2012.
- [11] Narkhede. H. P, "Review of Image Segmentation Techniques", International Journal of Science and Modern Engineering (IJISME), Issue 8, Vol. 1, PP. 54-61, July, 2013.
- [12] Maysaa. H. A, "Face Image Recognition Using 2D PCA Algorithm", Eng. & Tech. Journal, Vol. 31, Part (A), No.7, 2013.
- [13] Bo. P, Lei. Z, David. Z, "Automatic Image Segmentation by Dynamic Region Merging", IEEE Transactions on image processing, Vol. 20, No. 12, December, 2011.
- [14] Tim. R, Marwa. A, "Automatic Detection and Identification of Cells in Digital images of Day 2 IVF Embryos", Ph.D. Thesis, University of Salford, Salford, UK, 2012.
- [15] Zuber. H, "Design and Implementation of Car Plate Recognition System for Ethiopian Car Plates", M.Sc. Thesis, Addis Ababa University, Ethiopia, November, 2011.
- [16] Kabir. H, Hasan. M, "Real Time Detection and Recognition of Vehicle License Plate in Bangla", M.Sc. Thesis, Bangladesh University of Engineering and Technology, Bangla, August, 2011.