



ISSN: 0067-2904

Manufacture a Battery-like Supercapacitors with Electrodes of Graphene

Hend Kadhim Abdul-Rassol*, Adi Mahmoud Abdul-Hussein

Applied Physics Division, Applied Science Department, University of Technology, Baghdad, Iraq.

Abstract

A graphene-based battery-like supercapacitors (SC) were manufactured. The prime objective of this research was to use environmentally friendly and natural materials as possible for the SC electrodes, electrolytes and the separators. The SC were designed in cells like batteries, three types of plastic cases were used as SC cells; the electrode and electrolyte materials were mixed together and a solution formed and placed in the designed cell. The electrode material was graphene powder with different weights mixed with different volumes of electrolytes (which were: lemon juice, apple vinegar, H_2SO_4 and HNO_3), and the separators used were Polytetrafluoroethylene polymer (PTFE) and cellulose based parchment paper (PP).

Charging circuit was set, the cell SC charged with different charging rates and the voltage window was determined for each cell with different electrode/electrolyte/separator combination. Three of the fabricated cell SC were discharged through 0.5V LED light. The discharging rates were regular and the best was (1.22 volts discharged in 26 minutes). The capacitance of the discharged SC was calculated.

Also the mixed solutions were tested by XRD analysis and the surface microscopy done by scanning electron microscope (SEM). The XRD spectra for the mixed solutions shows high crystallinity for the graphene with two distinct peaks at (002) and (004) direction.

Keywords: Supercapacitors, Battery, Graphene-Based, Charging/Discharging.

تصنيع متسعات فائقة شبيهة بالبطارية بأقطاب من الكرافين

هند كاظم عبد الرسول*، عدي محمود عبد الحسين

فرع الفيزياء التطبيقية، قسم العلوم التطبيقية، الجامعة التكنولوجية، بغداد، العراق.

الخلاصة

تم تصنيع مكثفات فائقة شبيهة بالبطارية ذات أقطاب من الكرافين. حيث كان الهدف الرئيسي من البحث هو استخدام مواد صديقة للبيئة وطبيعية على قدر الامكان لأقطاب المتسعات الفائقة، الالكترولايت و المادة العازلة. صممت المتسعات الفائقة في خلايا شبيهة بالبطاريات، حيث تم استخدام ثلاث انواع من العلب البلاستيكية كخلية قطب المتسعة؛ وتم خلط مادة القطب مع الالكترولايت وشكلاً معاً محلولاً واحداً يستخدم ك خليط (قطب/الالكترولايت) وضع في خلية المتسعة الفائقة المصممة. كانت مادة القطب المستخدمة هو مسحوق الكرافين تم خلطه بأوزان مختلفة مع أحجام مختلفة من محاليل الالكترولايت وهي (عصير الليمون، خل التفاح، حامض الكبريتيك وحامض النتريك). و المواد العازلة المستخدمة هي (بوليمر متعدد رباعي فلورو الإيثيلين [التفلون]، وورق سيليلوزي)

*Email: h30.hend@gmail.com

تم أعداد دائرة كهربائية لشحن المتسعات المركبة، وبشحنها بمعدلات شحن مختلفة للفولتيات والتيارات؛ تم تحديد نافذة فرق الجهد لكل متسعة مركبة من مواد (قطب/الكتروليت/مادة عازلة) مختلفة. تم تفريغ الشحن لثلاث من المتسعات المصنعة بتشغيل ضوء ليد الى حين انطفائه. كانت معدلات التفريغ منتظمة وافضلها كان (تفريغ 1.22 فولت لمدة 26 دقيقة). وكذلك تم حساب السعة للمتسعات المفرغة رياضياً. تم فحص الخائص التركيبية لخليط (قطب/الكتروليت) بواسطة حيود الأشعة السينية (XRD)، وأظهر تضاريس العينة بواسطة المجهر الإلكتروني الماسح (SEM). أظهرت أطياف حيود الأشعة السينية لخليط (قطب/الكتروليت)، بأن الكرافين عالي التبلور بقميتين متميزتين في الاتجاهين (002) و (004).

Introduction

Supercapacitors (SC) and batteries are type of electrochemical energy storage systems varieties. Rechargeable batteries are usually being the first choice owing to their high energy density. Though, SC have longer life-time and higher power density compared to batteries, therefore SC are more favorable than batteries for some applications. They also can be used to supplement batteries to extend the battery's life-time. However, due to their high costs; the use of SC is still limited, most commercially available SC contain expensive electrolytes and costly electrode materials [1].

Electrochemical supercapacitors (ES) have been undergoing development since the concept was proposed by B.E. Conway in 1970s. The uprising of researches in ES was caused from the necessity in improvement the power of batteries, which are highly needed for many applications such as flash light in cameras, hybrid and electric vehicles. ES intrinsically have the ability of high power density, and the coupling of SC and batteries can provide steady energy supply and top power demands [2].

Experimental work

1. Supercapacitor Cells

Different plastic cases were constructed and prepared:

1. Cubic case (4cm^3) with separator window ($3.5 \times 3.5\text{cm}^2$), Figure- 1(a).
2. Circular petridish (5.5 cm diameter), Figure -1(b)
3. Rectangular case (14cm height \times 4cm width), Figure -1(c).

The current collectors (CC) used were thick foils of Cu and Al, placed at the opposite side in front of the separator window in each case, as illustrated in Figure-1.

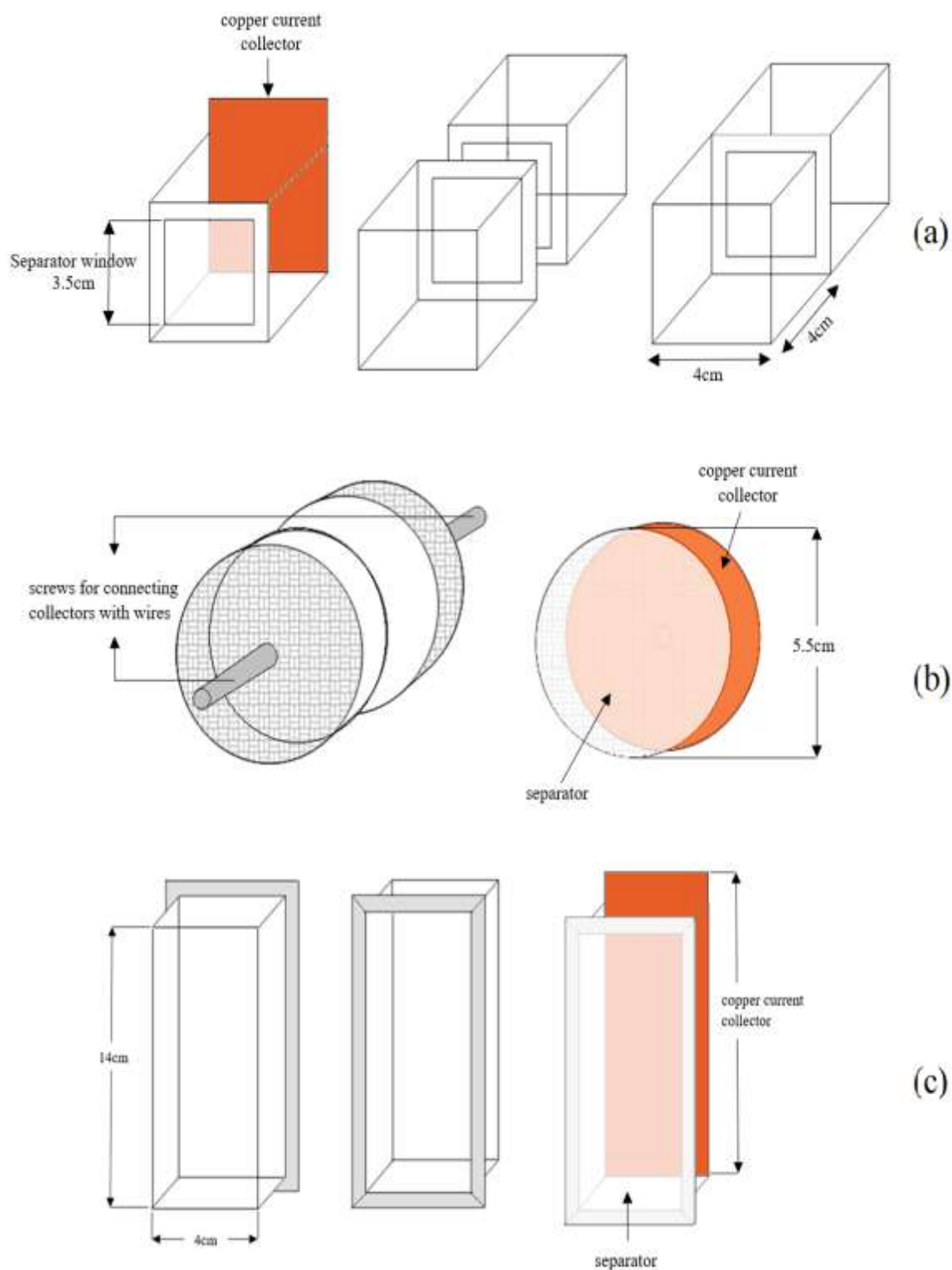

Figure 1- Illustrative image: a) Cubic case. b) Circular case. c) Rectangular case.

2. The Electrodes (Mixed Solutions)

The electrode material which was graphene powder; using several weights with different electrolyte volumes, were mixed together and placed in the different plastic cases as electrode/electrolyte solution.

Below Table-1, a list of all the solutions were mixed and tested; and given each one a short name to refer it with.

Table 1- Prepared mixed solutions.

Solution name	Graphene powder (gm)	Lemon juice (ml)	Apple vinegar (ml)	HNO ₃ :diluted with H ₂ O (ml)	H ₂ SO ₄ :diluted with H ₂ O (ml)
Sol.1	50	100	-	-	-
Sol.2	75	100	-	-	-
Sol.3	100	100	-	-	-
Sol.4	100	200	-	-	-
Sol.5	150	150	50	-	-
Sol.6	150	150	50	0.2:4	0.6:8
Sol.7	150	150	50	0.4:8	1.2:16
Sol.8	150	150	50	0.6:12	1.8:24

3. The Electrolyte

The main electrolyte used was lemon juice, and other solution with different volumes were add to test its benefits; which was (apple vinegar, sulfuric acid H₂SO₄, nitric acid HNO₃).

4. The Separator

Two separators were used, PTFE polymer (23 μ m) and cellulose based parchment paper (PP) (27 μ m).

5. Charging Circuit

The charging circuit consisted of: DC power supply, the assembled SC, voltmeter connected in parallel with SC terminals to measure the charged voltage, ammeter to measure the current through the circuit, and wires for connections, as demonstrated in Figure-2.

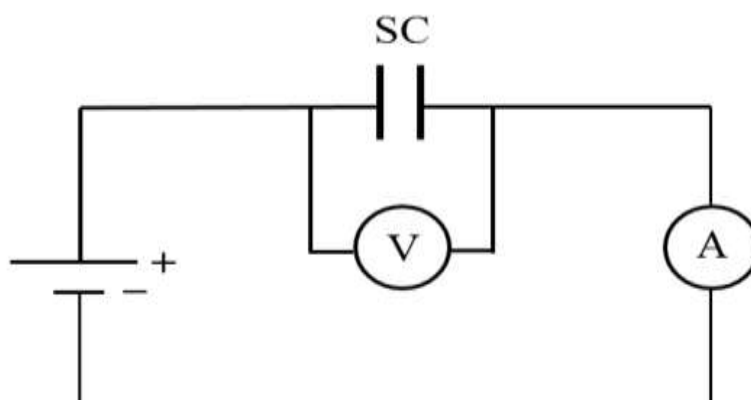

Figure 2-Illustrative image of the charging circuit.

1. Discharging Circuit

Three of the assembled SC cases were tested for their discharging abilities. The discharging circuit consisted of: the charged SC connected in series with (0.5V) small LED light, a resistor (50 Ω and

30Ω for each different case; considering their charged voltages), and an ammeter to measure the current through the circuit. Voltmeter is connect in parallel with SC terminals (CC) to measure the reduction in voltage, as demonstrated in Figure-3.

- The discharging (voltage: current) rate measured every 2 minutes.

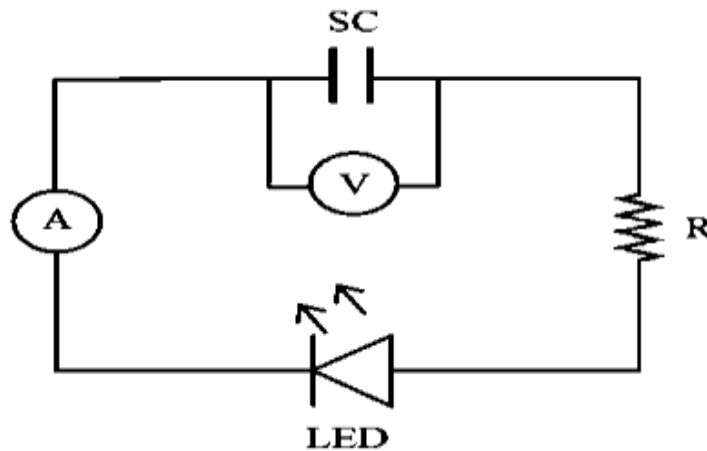

Figure 3- Illustrative image of the discharging circuit.

2. Capacitance Calculation:

From the discharging readings we were able to calculate the average capacitance of the three discharged SC, using the following equation [3]:

$$C = \frac{t_2 - t_1}{R \ln V_1 / V_2} \dots\dots\dots(1)$$

Where: *C* the overall capacitance, (*t₂-t₁*) the difference between two consecutive reading times, *R* the resistor’s value, *V₁* the voltage of the SC at *t₁* and *V₂* the voltage of the SC at *t₂*.

Equation.1 was applied for each consecutive reading to determine the capacitance in that moment, and by calculating the average of these capacitances, the overall capacitance of each SC was determined.

- The calculated overall capacitance of the three discharged SC are listed in Table-3.

Results and discussion

1. Voltage Charging with time:

The fabricated SC cells were charged by connecting with power supply as demonstrated in Figure -2 and by differing the charging voltages and currents, the SC were charged into certain voltage than became stable at that voltage; which considered the maximum voltage window the SC can reach. Table-2 lists all the maximum voltages for each assembled cell SC and the voltage across its electrodes before charging it.

Table 2- The highest and before charging voltages for each assembled cases.

Supercapaci- tor Number	Cell case	CC	Separator	Solution no.	Charging time (min)	Maximum charged
SC.1	Cubic case	Cu	PTFE	Sol.1	75	1.5
				Sol.2	75	2.2
				Sol.3	75	1.3
SC.2	Cubic case	Cu	PP	Sol.1	60	2.8
				Sol.2	75	2.4
				Sol.3	75	1.8
SC.3	Circular case	Cu	PP	Sol.2	40	1.25
				Sol.4	60	1.12
SC.4	Circular case	Al	PP	Sol.2	50	0.51
				Sol.4	60	0.52
SC.5	Rectangular case	Cu	PTFE	Sol.5	190	1.16
				Sol.6	200	1.16
				Sol.7	180	1.19
				Sol.8	180	1.22
SC.6	Rectangular case	Al	PTFE	Sol.6	140	0.54
				Sol.7	150	0.71

2. Cubic case – Cu CC – PTFE separator (SC.1):

The charging rates for the two cubic cases (SC.1&2) were started by charging (20V) and increasing 5 volts each 15 minutes (5V:15min) for 75 minutes.

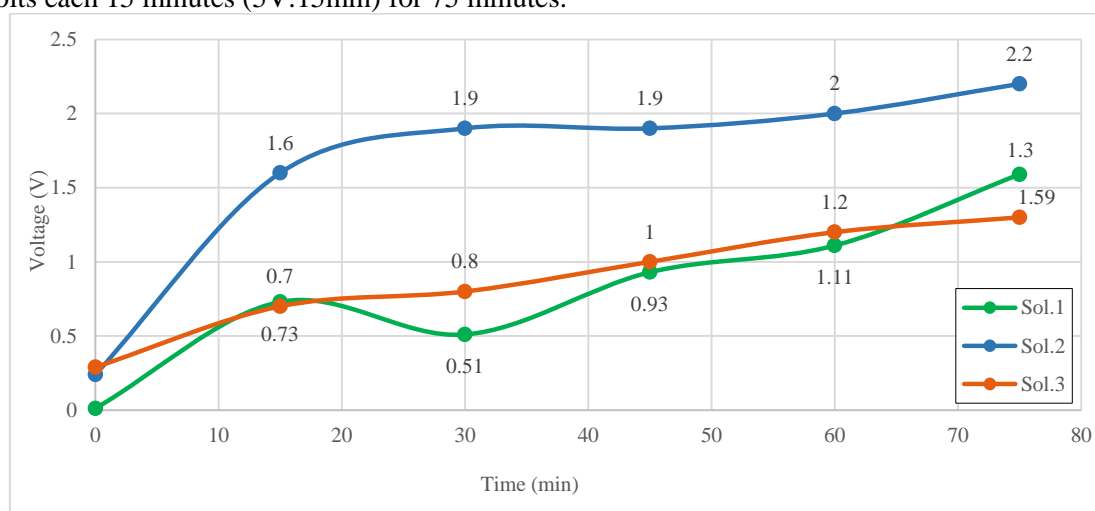
**Figure 4-** Charged voltage vs time for (SC.1).

3. Cubic case – Cu CC – PP separator (SC.2)

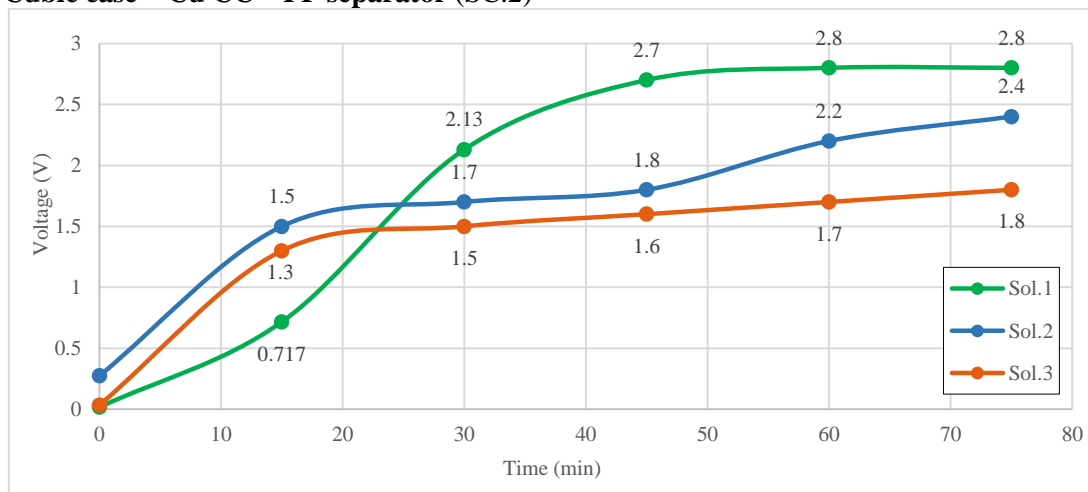

Figure 5- Charged voltage vs time for (SC.2).

4. Circular case – Cu CC – PP separator (SC.3)

The charging rates for the two circular cases (SC.3&4) were started by charging (1V) and increasing 1 volts each 10 minutes (1V:10min) for 60 minutes.

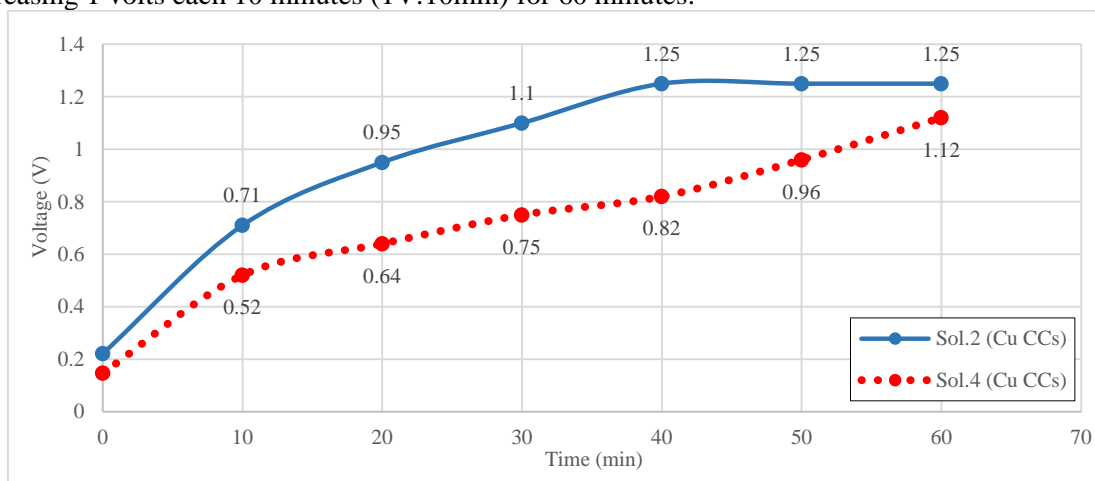

Figure 6- Charged voltage vs time for (SC.3).

5. Circular case – Al CC – PP separator (SC.4):

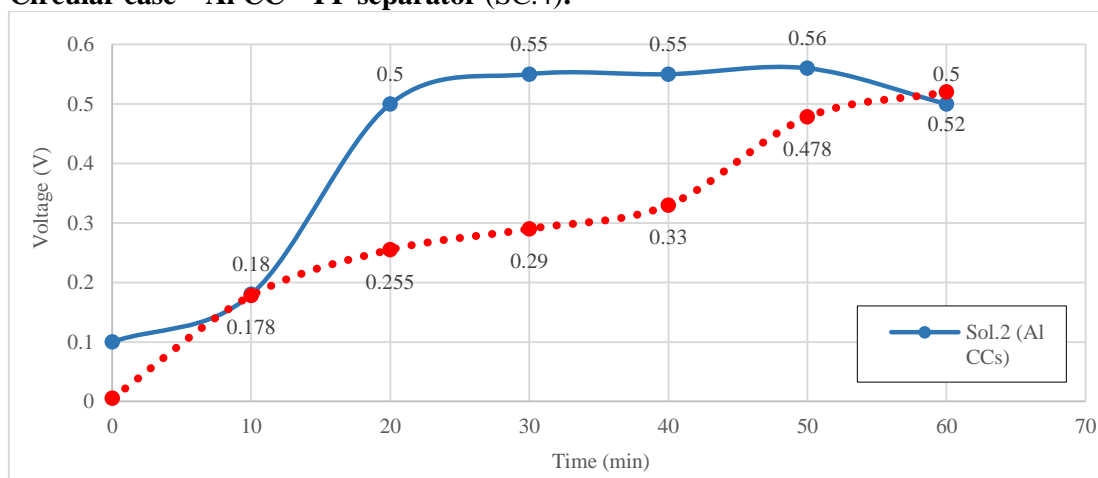

Figure 7- Charged voltage vs time for (SC.4).

6. Rectangular case – Cu CC – PTFE separator (SC.5):

The charging rates for the two rectangular cases (SC.5&6) were started by charging (1V) and increasing 1 volts each 10 minutes (1V:10min) for 200 minutes.

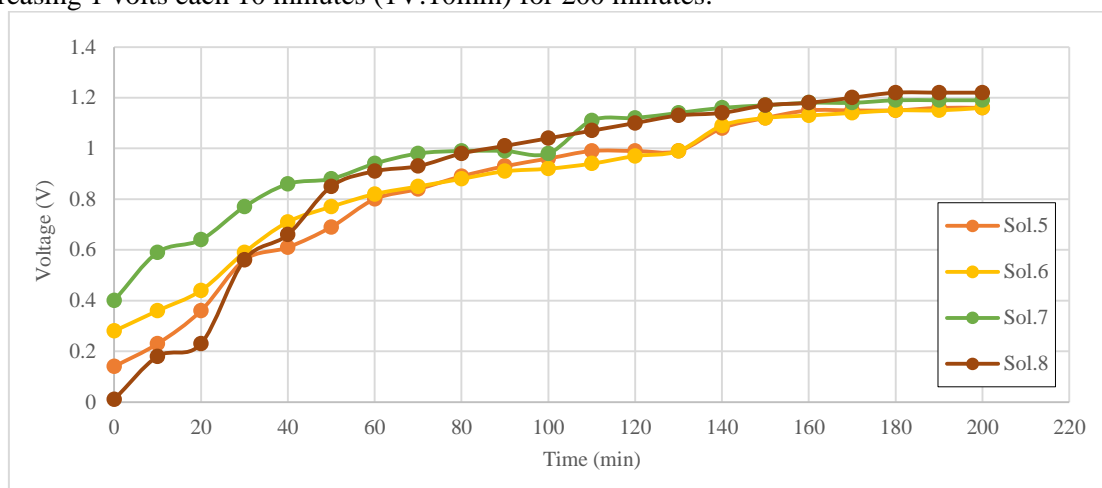

Figure 8- Charged voltage vs time for (SC.5).

7. Rectangular case – Al CC – PTFE separator (SC.6):

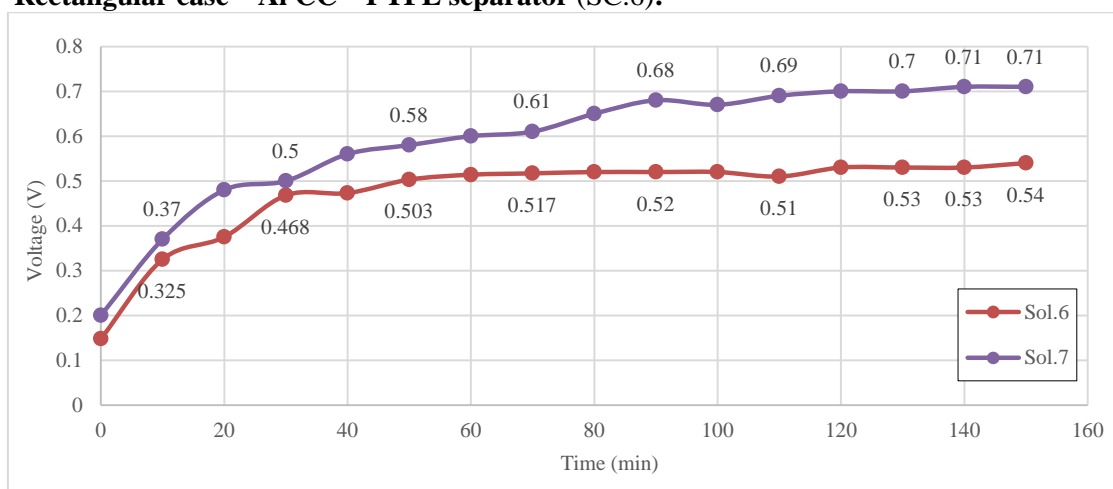

Figure 9-Charged voltage vs time for (SC.6).

As a summary for the charging results, we had:

1. The highest charged voltage was (2.8 volts) for the cubic case with electrode/electrolyte mixture of (100ml lemon + 50gm graphene powder), PP and Cu as separator and CC respectively, and the highest applied voltage was (40V) reached after (55 min) with charging rate of (5V:15min).
2. The (Cu) foils served as current collectors much better than (Al); as expected.
3. The circular case design didn't work efficiently because the screws which were used as wire connectors started to oxidize with the mixture and a rust layer were formed; which reduced the connections between the screw and the Al and Cu foils.
4. Thin foils of Al and Cu first used as CC with the cubic cases, but when charging it to high voltages about (30V), it started to splinter and decompose within the mixture, it didn't bear the high voltages and temperatures.
5. Almost every assembled cases had their voltage window at (20-25V).
With increasing the charging voltage the mixture and the case temperature raised.

3. Discharging with Time:

The discharging circuits were set as shown in Figure-3, three SC were discharged through the 0.5V LED light, and the discharging rates were measured every 2 minutes. Table-3 lists the charged voltage of each tested SC, their discharging time, and the minimum voltage reached at that time; when the LED turned off.

Table 3- Values and readings for the discharging circuits.

Combina- tion no.	Solution no.	SC Charged voltage (V)	Minimum voltage	Discharging time (min)	Resistor used (Ω)	Capacitance (F)
SC.2	Sol.3	1.8	0.48	29	50	0.82
SC.5	Sol.6	1.16	0.51	18	30	0.94
SC.5	Sol.8	1.22	0.52	26	30	1.31

As a summary for the discharging results, we had:

1. The discharging (voltage: current) values were regular and in consistent rates.
2. The best discharging rate with time was for (SC.5, Sol.8).
3. The brightness of the LED was stable and bright at high voltages, but it started to dim and goes down until it turn off.

Next, charts showing the discharging (voltage: current) rates, and the voltage rates decreasing with time.

8. Sol.3 – SC.2 (Cubic case – Cu CC – PP separator):

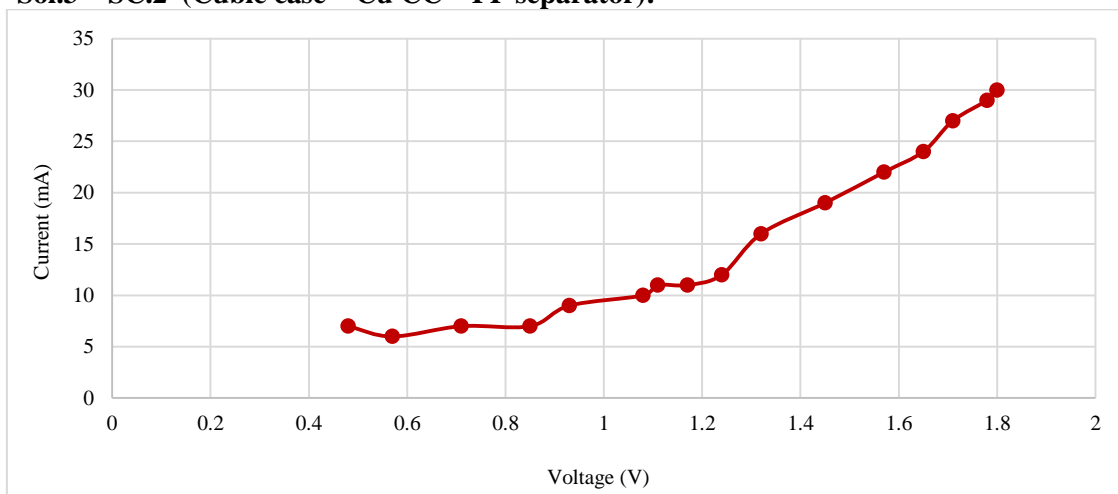

Figure 10- Voltage-Current discharging values for (SC.2).

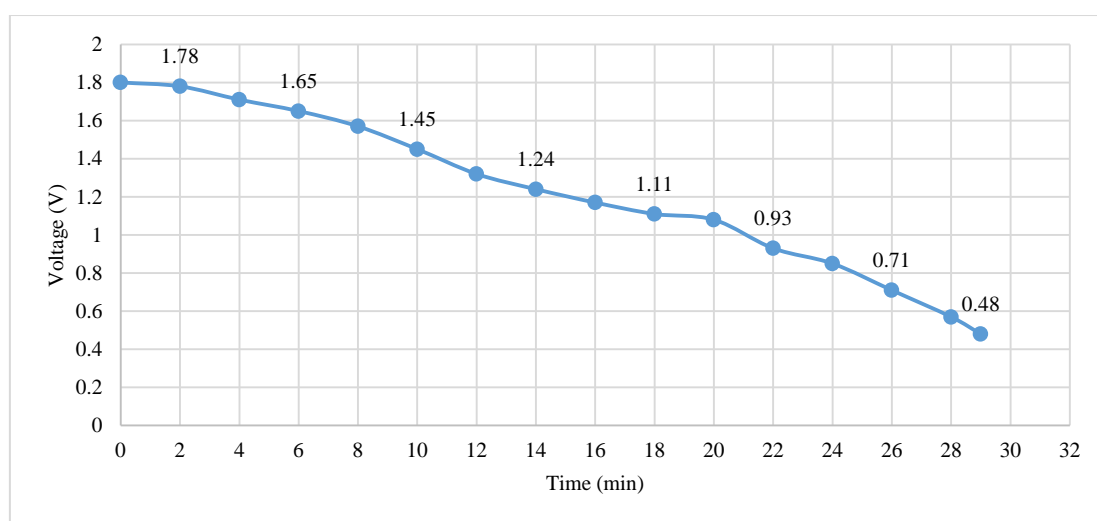

Figure 11-Discharged voltage vs time for (SC.2).

9. Sol.6 – SC.5 (Rectangular case – Cu CC – PTFE separator):

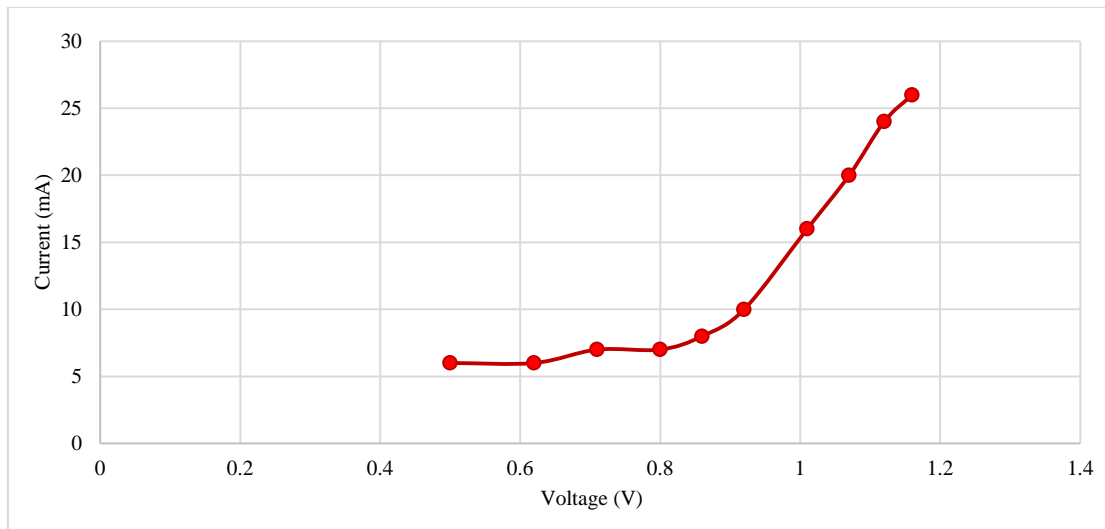

Figure 12-Voltage-Current discharging values for (SC.5).

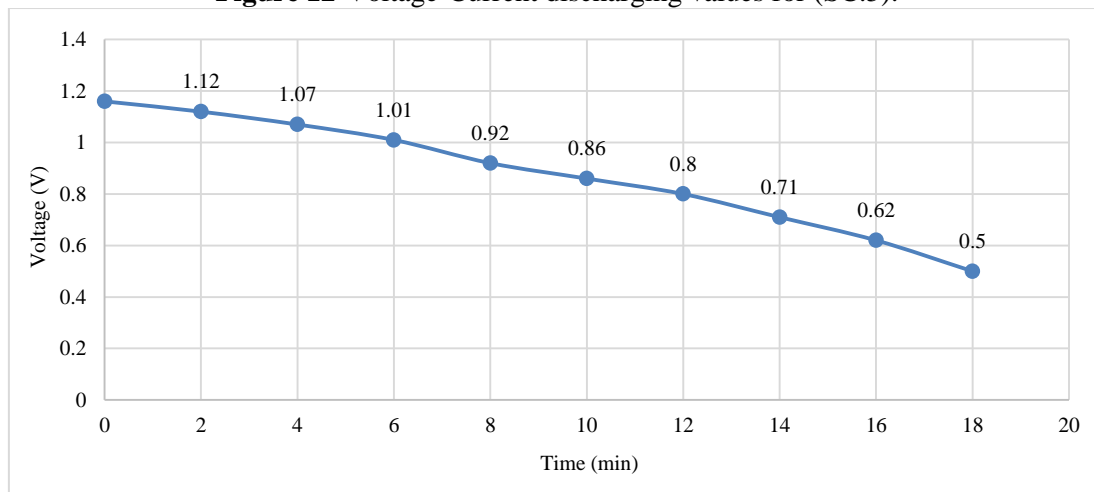

Figure 13- Discharged voltage vs time for (SC.5).

10 Sol.8 – SC.5 (Rectangular case – Cu CC – PTFE separator):

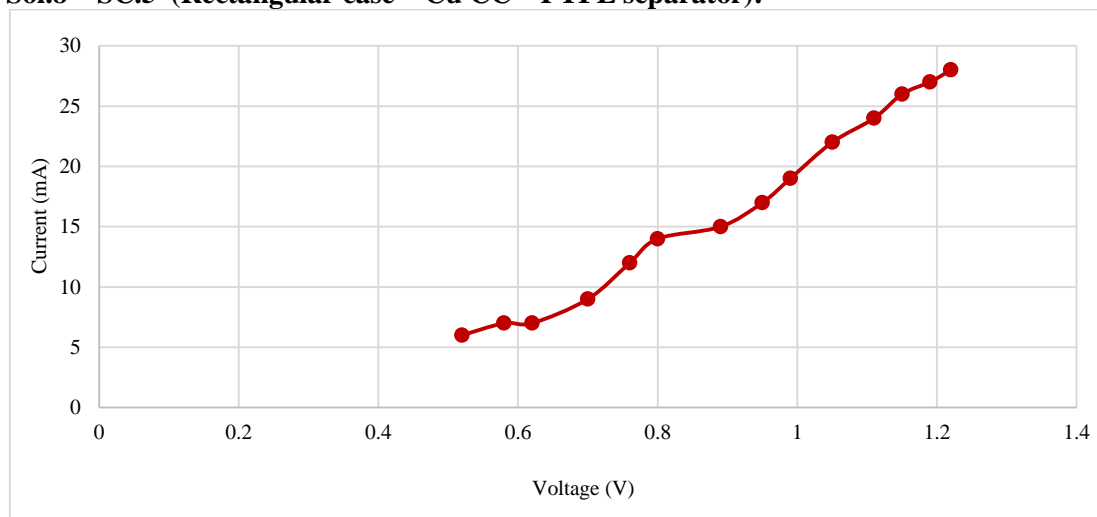

Figure 14- Voltage-Current discharging values for (SC.5).

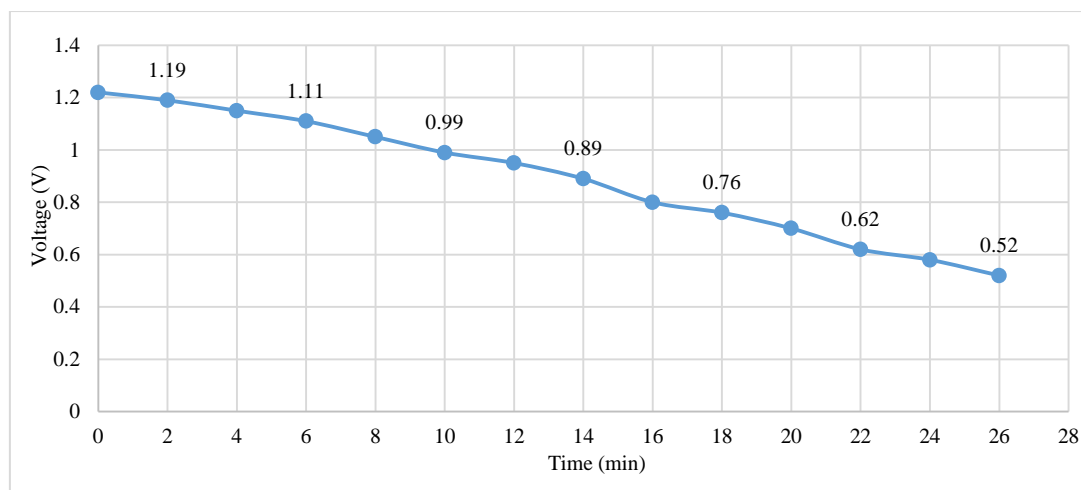

Figure 15- Discharged voltage vs time for (SC.5).

4. X-Ray Diffraction Analysis:

XRD is used to determine the quality and the stage of the graphene powder used in the solution by characterizing the specific peaks in the XRD patterns, and comparing it to the (JCPDS card data 23-0064) Figure-16.

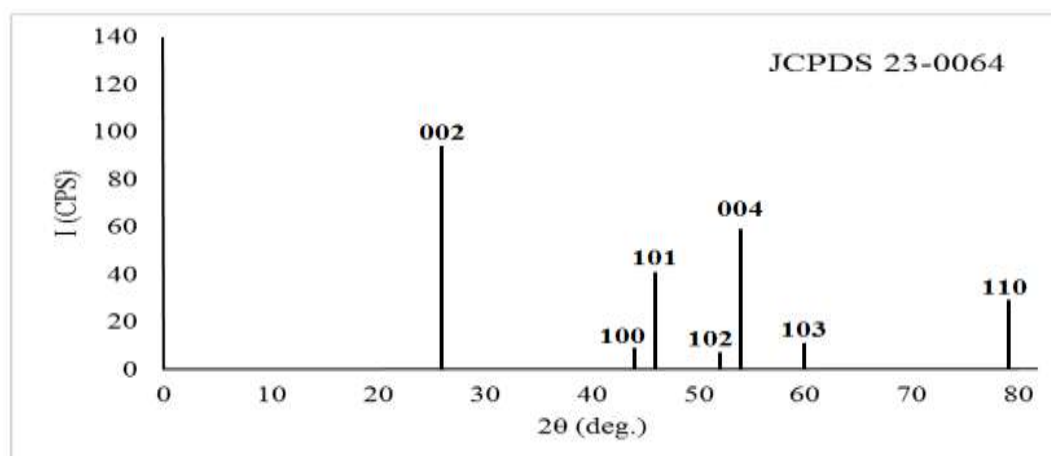

Figure 16- XRD patterns of MLG, JCPDS 23-0064 data card [4].

The XRD patterns of the mixed solution (Sol.1 and Sol.8) are shown in Figures- (17, 18) respectively, which show slightly difference in the intensity for the two solution due to the adding of the acids.

The strong and sharp peaks at ($2\theta = 26.51^\circ$) and ($2\theta = 26.57^\circ$) are corresponding to an interlayer distance of ($d = 3.358\text{\AA}$) and ($d = 3.351\text{\AA}$) respectively for (002) orientation, which is consistent with the d spacing of JCPDS standard cards (32-0064) [5].

The (002) peak is slightly compatible with the pristine flake graphite literature data (JCPDS 75-2078), due to the decrease in the interlayer spacing in MLG. They are also compatible with exfoliated graphite nano-platelets (xGnP), these nanoparticles consist of small stacks of graphene that are (1 to 15 nm) thickness. The X-ray peak patterns of xGnP would resemble that of graphite, in that the (002) peak would still appear at ($2\theta \approx 26^\circ$). However, the peak appears considerably smaller and broader. That indicate that inter planar distance in xGnP is similar to the parent pristine graphite, but the stack size of graphene layers is small [6].

There is also a very weak diffraction peaks (004) at ($2\theta = 54.62^\circ$) and ($2\theta = 54.69^\circ$) corresponding to an interlayer distance of ($d = 1.678\text{\AA}$) and ($d = 1.676\text{\AA}$) respectively. The peak (004) is the second diffraction of the diffraction peak (002) according to the layer spatial arrangement rules of microcrystals, thus peak (004) intensity is much weaker than that of peak (002) [7].

The plan pattern (hkl) consists of the ($00l$) crystalline reflections (002) and (004). The ($00l$) is a type of 2-D lattice reflection produced by individual graphite layers taking independently all orientations in space, and proving that there are several graphite layers roughly parallel with each other [8].

Table-4 reveals the obtained results from the XRD analysis, with the calculated average particle size.

Table 4- The results obtained from the XRD analysis for SC solutions.

Sol. no.	(hkl) plan	2θ (deg.)	FWHM (rad.)	d (\AA°)	Dg (nm)
Sol.1	G (002)	26.51	0.00932	3.358	15.09
	G (004)	54.62	0.00932	1.678	16.55
Sol.8	G (002)	26.57	0.00921	3.351	15.28
	G (004)	54.69	0.00973	1.676	15.82

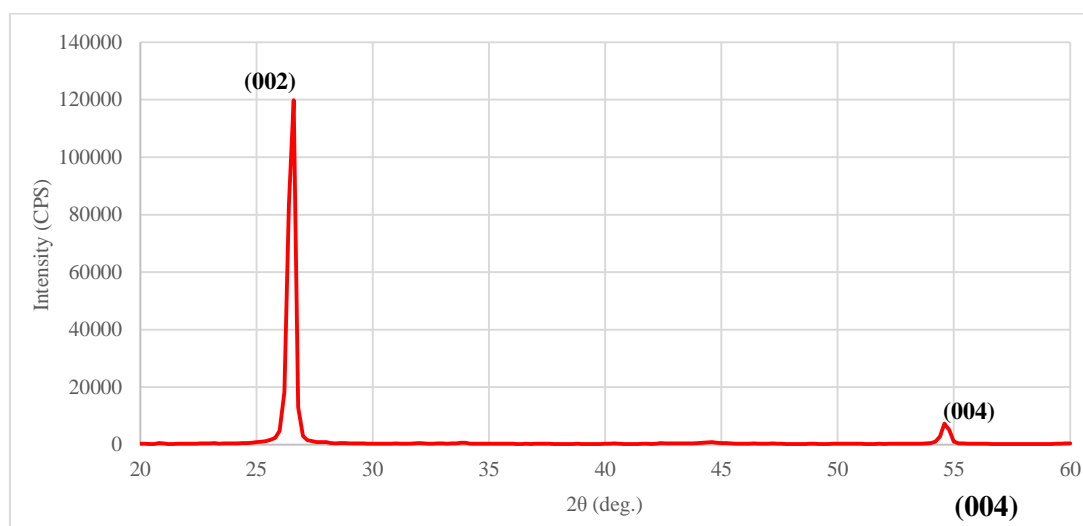

Figure 17-XRD spectra of Sol.1.

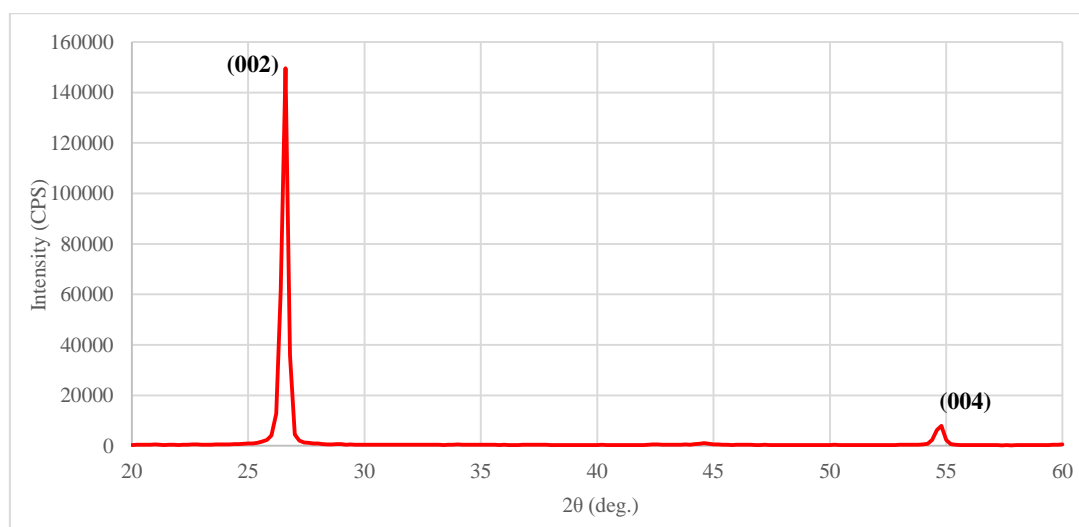

Figure 18- XRD spectra of Sol.8.

4. Scanning Electron Microscope (SEM) Images:

Figures- (19, 20) show the SEM images for the mixed solutions (Sol.5) and (Sol.8) respectively, in four magnification powers (x1000, x2000, x4000, and x7000).

Due to the adding of the strong acids (H_2SO_4 and HNO_3), it is clear from the SEM images that the graphene particles were exfoliated into smaller sizes.

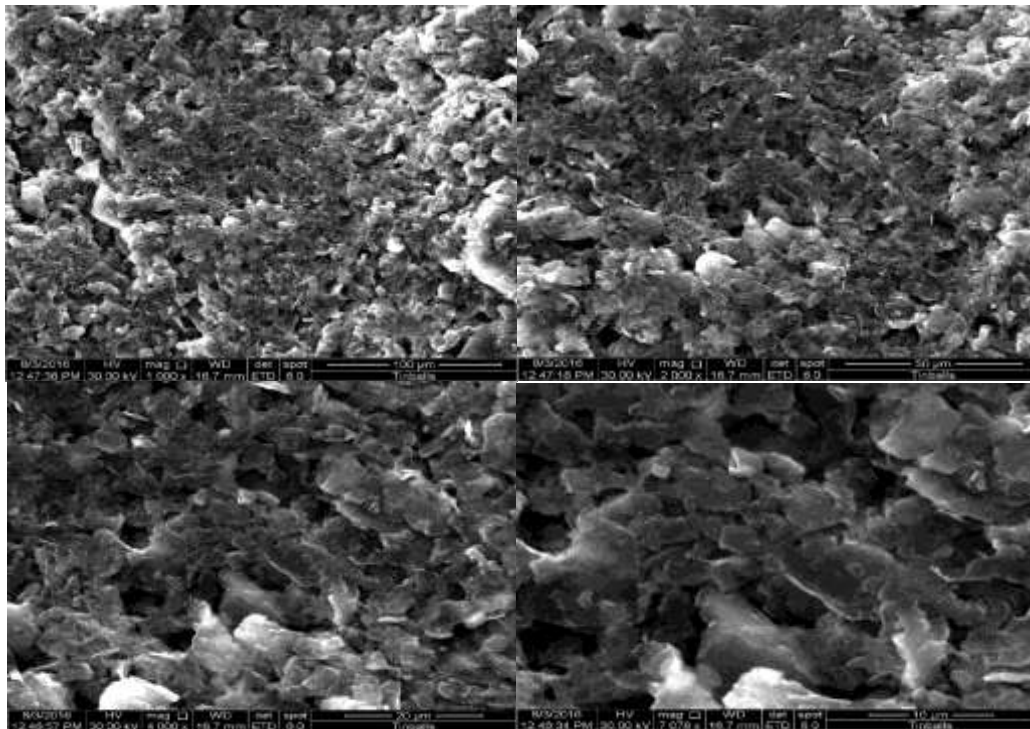

Figure 19- SEM images for (Sol.5).

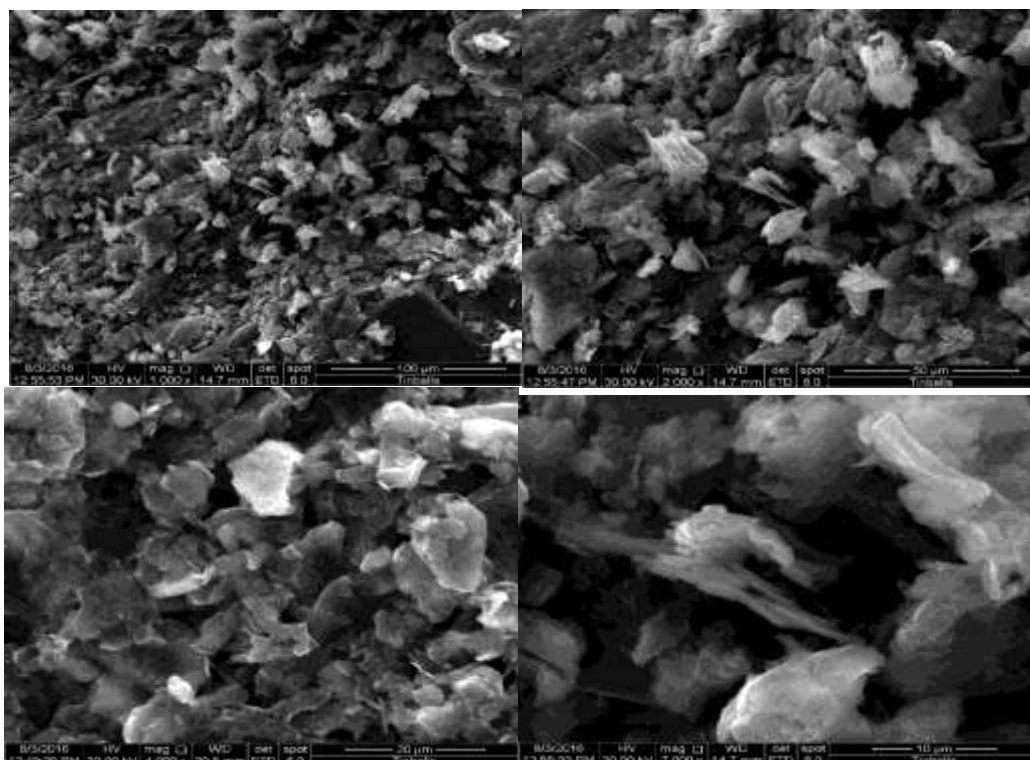

Figure 20- SEM images for (Sol.8)

Conclusions

We can summarize the main conclusions to these remarked points:

1. The highest charged voltage for the cell SC was (2.8V) for the cubic case, PP separator, Cu as a current collector, and the electrode/electrolyte solution was (50gm graphene + 100ml lemon juice), the charging voltage was at maximum (40V) reached after (55 min).
2. The lowest charged voltages was for the cell SC with the Al as CC.
3. Stopped reaching higher voltages at (30V), because increasing the charging voltages and currents the solutions temperature started increasing, as also the temperature of the cell cases; and as determined most of the combinations have their voltage window at (20-25 volts).
4. The best discharging rates was for (SC.5, Sol.8).
5. The adding of the apple vinegar, and the strong acids had these results: A) increased the charged voltage window of the SC. B) graphene powder particles was exfoliated into smaller sizes as shown in the SEM images. C) The intensity of the XRD peak was higher, which concluded it was a better solution in every aspect.

References:

1. Tarascon, JM. and Armand, M. **2001**. Issues and challenges facing rechargeable lithium batteries. *Nature*, **414**: 359-67.
2. Su, Y., Zhitomirsky, I. **2013**. Electrophoretic nanotechnology of composite electrodes for electrochemical supercapacitors. *The Journal of Physical Chemistry B.*, **117** (6): 1563-70.
3. Demtroder, W. **2013**. *Experimental physik 2: Measurement of Capacities, Charging and Discharging of Capacitors*. Springer-Verlag, Berlin.
4. Mustafa, K. and Abd, M. **2015**. Flame synthesis of Graphene multi-layer films in open environments. Thesis for the degree of Master of Science in applied physics, University Of Technology - Iraq.
5. Tao, Y., Yi, D. and Zhu, B. **2012**. Effect of reaction temperature on carbon films prepared by a hydrothermal electrochemical method. *Materials Science-Poland*, **30**(1): 17-22.
6. Alam, S.N., Kumar, L. and Sharma, N. **2015**. Development of Cu-Exfoliated Graphite Nanoplatelets (xGnP) Metal Matrix Composite by Powder Metallurgy Route. *Graphene*, **4**: 91-111.
7. Ning Cao and Yuan Zhang. **2015**. Study of Reduced Graphene Oxide Preparation by Hummers' Method and Related Characterization. *Journal of Nanomaterials*, **2015**, Article ID 168125: 5 pages.
8. Warren, B. E. **1954**. X-Ray Study of the Graphitization of Carbon Black. The American carbon society, proceedings of the conferences on carbon.