



AN EXPERIMENTAL STUDY FOR THE EFFECT OF CAPILLARY TUBE DIAMETER ON REFRIGERATOR PERFORMANCE WITH NEW ALTERNATIVE REFRIGERANT MIXTURE TO R134A

Ali K. Al-Sayyab¹

**¹ Thermal Mechanical Engineering Department, College/of Technical Engineering-
Basra, Southern Technical University, Email: ali.alsayyab@stu.ed.iq**

<http://dx.doi.org/10.30572/2018/kje/090203>

ABSTRACT

In this work, the effect of capillary tube diameter on refrigerator performance is studied for refrigerants R134a, R290, R600a and its mixture which named: RMix1(70%R134a,20%R290,10%R600a), RMix2(70%R134a,10%R290,20%R600a), RMix3.(50%R134a,20%R290,30%R600a), RMix4 (60%R134a,20%R290,20%R600a). The three adopted capillary tubes diameter are 1.4 mm, 1.8 mm and 2.2 mm, named capillary1, capillary2 and capillary3 respectively. The experimental work show that, the refrigerator operates in 2.2 mm capillary tube's diameter with R134a gives the highest COP from other refrigerants with the same diameter, where the performance of refrigerator with capillary tube of 1.4 mm and alternative ozone friendly refrigerant RMix2 give 1.3% COP reduction from base case of R134a .

KEYWORDS: Capillary Tube, refrigerant mixture, refrigerat

NOMENCLATURE

Symbols	Description	Unit
COP	Coefficient Of Performance	
q_c	Heat rejected by condenser	kJ/kg
w_{scom}	Compressor Specific work	kJ/kg
q_e	Refrigerating effect	kJ/kg
H	Enthalpy of refrigerant	kJ/kg
m_i	Mass fraction	

1. INTRODUCTION

Every refrigerating unit requires a pressure-reducing device to meter the flow of refrigerant from the high pressure side to the low pressure side of the refrigerating system according to load demand. The capillary tube is especially popular for smaller unitary hermetic equipment such as household refrigerators and freezers, dehumidifiers, and room air conditioners. Capillary tube use also extends to larger units such as unitary air conditioners in sizes up to 35 kW capacity. The capillary operates on the principle that liquid passes through it much more readily than vapor. It is a length of drawn copper tubing with a small inner diameter. When used for controlling refrigerant flow, it connects the outlet of the condenser to the inlet of the evaporator. Despite its small inner diameter, the term capillary tube is a misnomer because the inner bore is much too large to allow capillary action. A capillary tube must be compatible with other components. In general, once the compressor and condenser have been selected to meet the required design conditions, the capillary tube size and system charge are determined. However, detailed design considerations may be different for different applications and different refrigerant. A capillary tube passes liquid much more readily than vapor due to the increased friction with the vapor; as a result, it is a practical metering device. If capillary tube properly sized for the application, it compensates automatically for load and system variations and gives acceptable performance over a wide range of operating conditions (ASHRE, 1998).

There are many studies performed on capillary tube size and configurations. Issam et al., (2005) did an experimental study to perform the effect of capillary tube size on system performance work with R134a and R12, they used three capillary tube with different size 0.81mm ,1.4 mm and 1.5 mm .they found that the temperature gradient for the two refrigerants are the same, but after approximately one meter the temperature gradient of R-134a is faster than R12. Decreasing the discharge causes faster temperature gradient leads to faster vaporization. The effect of changing the discharge becomes insensible for small diameters. Poolkrajang et.al., (2009) studied the effect of capillary tube on spilt unit performance working with R22, they use five capillary tube with different size ,the results show that the refrigerant effect increases as the capillary tube diameter decreases ,while any change to the capillary tube diameter will give very little effect on Compressor work(no changes) ,and COP tends to be higher as the diameter of capillary tube decreases. Salim, (2012) used more than capillary tube. He showed when the capillary tube coil number increases, the compressor power decreases by 10.3% and refrigerant effect increases by 1.6%. So COP trends to be higher by 13.51%. And when the capillary coils number increasing from 0 to 4, the mass flow rate will increase by 4.3%. They found the best

coil number depending on the mass flow rate change is 4. [Matani and Mukesh \(2013\)](#) did an experimental test to show the effect of tube diameter with different refrigerant on refrigeration system performance; they use R134a, R401a and mixture R600a/R290, the results show that the system with HC mixture (R290/R600a); and capillary diameter 0.050 inch has higher COP from all tested refrigerant at all testing condition. Therefore it can be used as alternative refrigerant in air conditioning system. [Shekhar et.al, \(2014\)](#) study the capillary tube diameter and coiled formation on system performance, they used three capillary tube with different coiled shape helical, straight and serpentine. They revealed that the straight formation show maximum mass flow rate and helical coiled give the least. And the maximum cooling effect if found to be for the helical coiled and least for straight coiled. The system mass flow rate is increase as the capillary tube diameter decreasing. [Abed et al, \(2014\)](#) did experimental study to show the effect of the coiled diameter of capillary tube they found that coiled diameter of capillary tube affect the cycle COP strongly, so as the capillary coiled diameter increases from 25 to 100 mm the cycle COP increases from 2.8 to 3.7. The increases of coiled diameter more than 100 mm shows insignificant effect on the cycle COP. [Farayibi et.al, \(2016\)](#) study the effect of capillary tube line number on system performance .They found that as increasing the capillary tube number from one to three, the refrigerating effect was increase, while the compressor work decrease. So COP of the system was increase in the order of 5.69 ± 0.04 , 6.24 ± 0.04 and 6.71 ± 0.04 when one, two and three capillary lines were respectively used. The current study all tests are carried out with three capillary tube with same length of 3 meter but with different inner tube diameter 1.25 mm, 1.65 mm and 2.05mm, all tested are performed for refrigerant named R134a, R600a,R290,

RMix1(70%R134a,20%R290,10%R600a),RMix2(70%R134a,10%R290,20%R600a),

RMix3(50%R134a,20%R290,30%R600a),RMix4(60%R134a,20%R290,20%R600a).

Thermodynamic System Analysis:

The vapour compression cycle consist from: compressor, evaporator, condenser, and expansion valve. In an ideal refrigerator cycle, there are four thermodynamic process [Fig. 1](#):

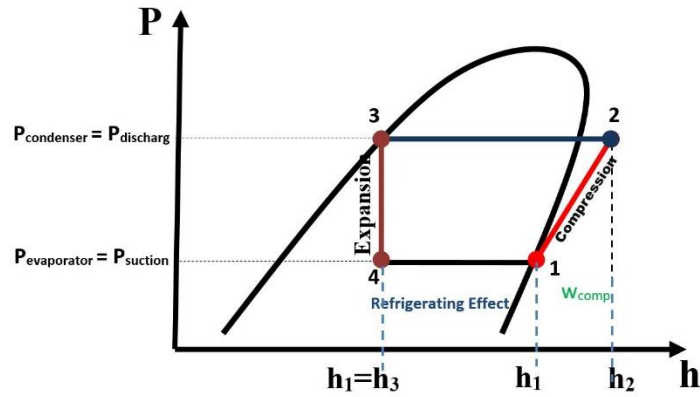

Fig. 1. Vapour compression cycle on P-h diagram (Ballaney, 2012).

ADIABATIC COMPRESSION AT COMPRESSOR (PROCESS 1-2):

The amount of specific work done by compressor per unit mass of the refrigerant, can be expressed regarding the change in enthalpy between State 1 and State 2.

$$w_c = h_2 - h_1 \quad (1)$$

CONSTANT PRESSURE HEAT REJECTION AT CONDENSER (PROCESS 2-3)

For the condenser the energy equation can be written as the enthalpies of refrigerant at the entrance and exit:

$$q_C = h_2 - h_3 \quad (2)$$

ADIABATIC THROTTLING AT CAPILLARY TUBE (PROCESS 3-4)

For the capillary tube the energy equation can be written as:

$$h_3 = h_4 \quad (3)$$

CONSTANT PRESSURE HEAT ADDITION AT EVAPORATOR (PROCESS 4-1)

The amount of specific heat absorbed by evaporator can be found by evaluating the refrigerant enthalpies at the inlet and outlet:

$$q_E = h_1 - h_4 \quad (4)$$

To get an indicted about the vapour compression cycle performance the coefficient of performance should be adopted ,which is the proportion of refrigerating effect to the work done by compressor, which used to give an:

$$\text{COP} = \frac{\text{Heat absorbed by evaporator}}{\text{Compressor Work}}$$

$$\text{COP} = \frac{h_1 - h_4}{h_2 - h_1} \quad (5)$$

PROPERTIES OF REFRIGERANTS MIXTURES:

Simple way of evaluating the extensive properties of a non-reacting ideal or real-gas mixture: Just add the contributions of each component of the mixture .Then the total internal energy, enthalpy, and entropy of a gas mixture can be expressed, respectively (Richard, 2013), as:

$$U_m = \sum_{i=1}^k U_i = \sum_{i=1}^k m_i u_i$$

$$H_m = \sum_{i=1}^k H_i = \sum_{i=1}^k m_i h_i$$

$$S_m = \sum_{i=1}^k S_i = \sum_{i=1}^k m_i s_i$$

2. SYSTEM EQUATIONS MODELING:

In this study , all The equations related to energy analysis and other properties of refrigerant are performed using Engineering Equation Solver Professional program (EES)version 9.8, which is a powerful mathematical program developed by Dr. Sanford Klein of the University of Wisconsin (1992-2013). EES has a built-in thermodynamic and transport property relations, graphical skills, numerical integration, and various other useful mathematical functions, Engineering Equation Solver can fast solve scores of transcendental equations.

3. EXPERIMENTAL WORK:

The Experimental test's rig is a lab. refrigerator that is manufactured by Prodit Ltd, that designed to work with R134a .Same modification are done on the refrigerator that are three manual valves are connected to the capillary tube inlets , header pipe that connected at capillary tubes outlet and there capillary tube with same length of 3 meter and different diameter of 1.4 mm, 1.8 mm and 2.2 mm, which named capillary1, capillary2 and capillary3 respectively, so the capillary tube of 2.2 mm is the bases case of compression (the designed capillary tube by Prodit manufacturing). The refrigerator consists from the main four components: hermetic compressor, wire- tube air cooled condenser, capillary tube and plate type evaporator, the refrigerator have measuring devices two pressure gauges, one connected on the suction side to

measure the evaporator pressure, and another gauge is connected on the discharge side to measure the condenser pressure. Also to measure the temperature of refrigerant the refrigerator have many digital thermometers, which attached to the inlets and outlets of the compressor, condenser and evaporator. To charge R134a and its alternatives mixture into the refrigerator an electronic charging scale system has been used. That automatically charge the required amount of refrigerant with circumstantially. The charging scale device consists of a joystick with LCD, balancer, solenoid valve and charging hoses. The cylinder of charging was putted on the balancer. The refrigerant required amount is selected by joystick control panel. The outlet of the refrigerant cylinder is connected with the inlet of the electronic valve of charging scale by charging hose, and the outlet of electric valve was connected with service port of the refrigerator. Fig. 2 shows the test rig and procedure of refrigerant charging .

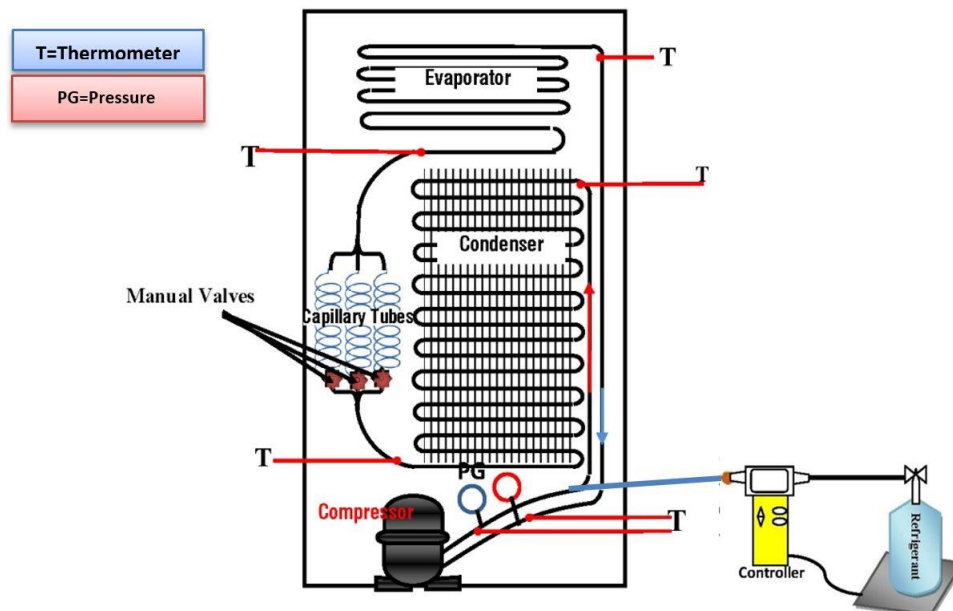

Fig. 2. Schematic diagram of test rig.

4. RESULT AND DISCUSSION:

4.1. EFFECT OF CAPILLARY TUBE ON COMPRESSOR WORK:

The Fig. 3 show that the refrigerator operate with R134a, the compressor work will decrease as the capillary tube diameter increase and the refrigerator with capillary3 has the lowest compressor work, because of the lower pressure ratio over capillary 3 as compared with other tested capillary tubes Fig. 4, where the refrigerator working with R290 and capillary tube 3 has

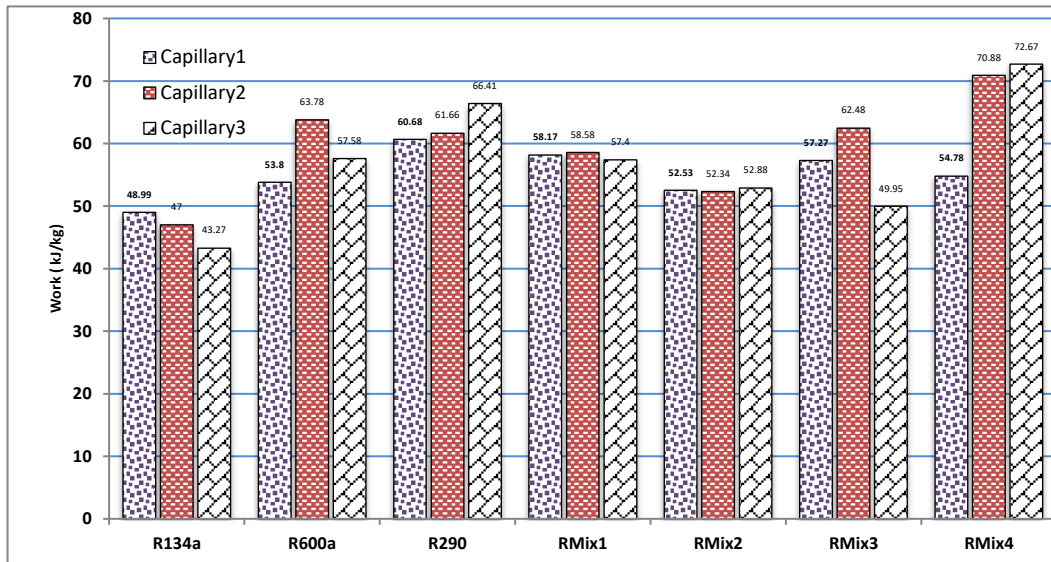

Fig. 3. Compressor work Vs capillary tube Diameter.

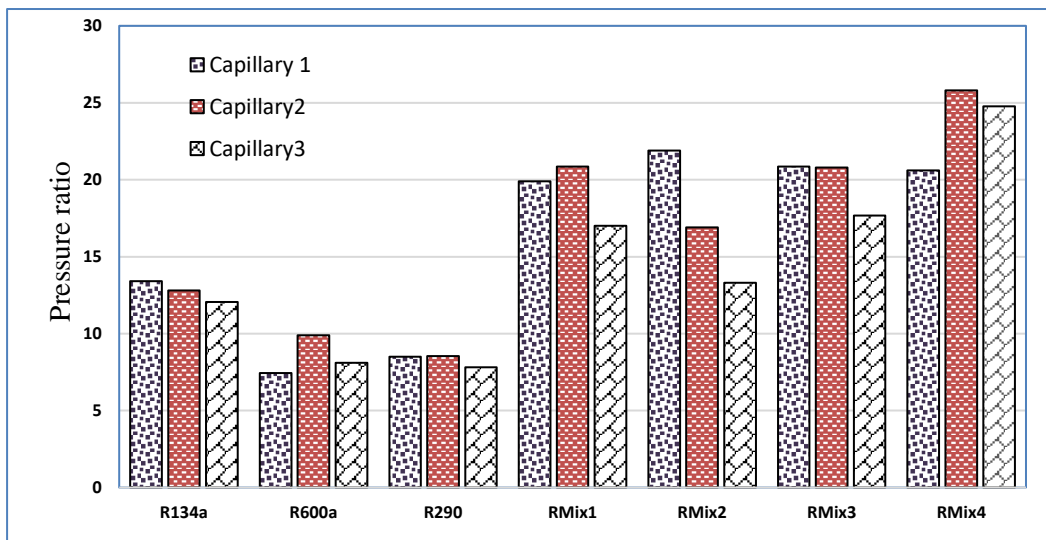

Fig. 4. Pressure ratio Vs capillary tube diameter.

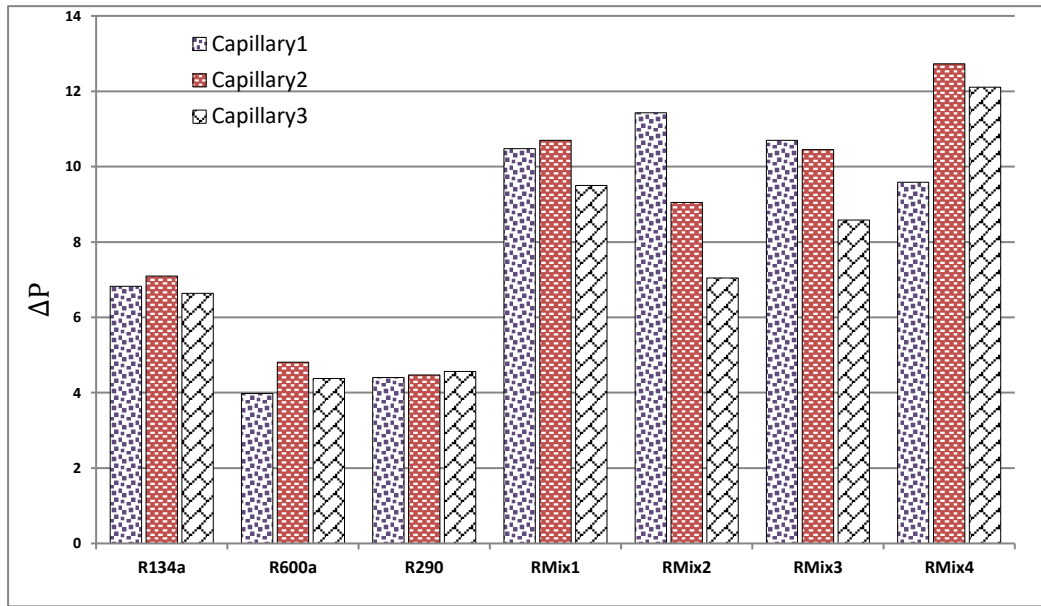

Fig. 5. Pressure ratio Vs capillary tube diameter.

4.2. EFFECT OF CAPPILARY TUBE ON REFRIGERATING EFFECT:

Refrigerating effect is the refrigerant enthalpies subtraction at the outlet and inlet, so the refrigerant state at evaporator inlet is always in wet state (Mixture gas and liquid). From Fig. 6 for refrigerant R134a as the capillary tube increase the refrigerant effect increase also because the small capillary tube diameter has more pressure drop across it, so as the pressure drop increase Fig. 5 this will lead to more head generated so more vapour Fig. 7, and this will led to reduce the amount of saturated liquid that required to absorb heat at evaporator, then refrigerating effect. But opposite for other refrigerant as the capillary tube decrease the refrigerant effect increased, because of these refrigerant have liquid viscosity leases than of R134a and this lead to less friction resistance and less pressure drop Fig. 5 then heat generated, so more liquid refrigerant at evaporator inlet.

4.3. EFFECT OF CAPPILARY TUBE ON COP:

The coefficient of performance of a refrigeration machine is the ratio of the energy removed at the evaporator (refrigerating effect) to the work done by the compressor. From Fig.6 the refrigerant R134a with capillary tube 3 is the base case. For R134a, the refrigerator operate with capillary tube 1 and 2 have less value of COP as compare with base case; due to the high compressor work with less refrigerating effect . For refrigerator work with RMix2 refrigerant and capillary tube1 give highest COP from other diameter and can be selected as optimum capillary tube diameter. So the COP of the refrigerator that operate with RMix2 and capillary tube1 give more close to that of base case; and can be selected as the best alternative selection

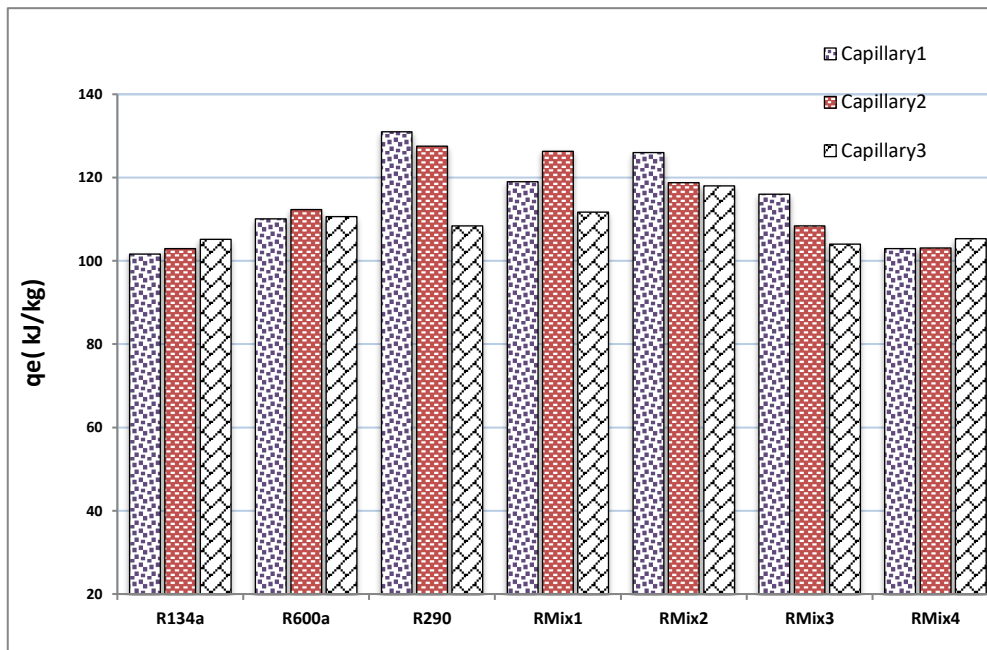

Fig. 6. Refrigerating capacity Vs capillary tube diameter.

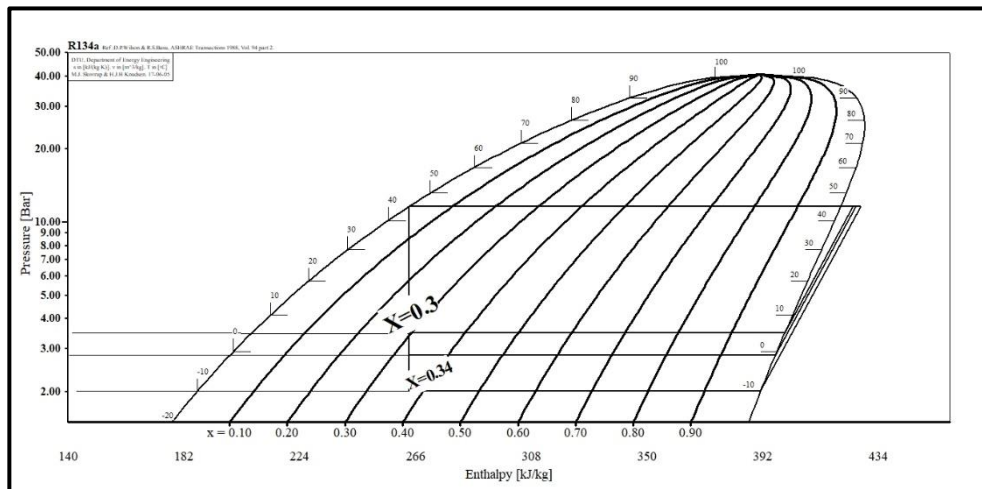

Fig. 7. Dryness fraction Vs pressure drop R134a.

for R134a. the refrigerator that performed with capillary tube 2 and with any refrigerant have less COP as compared with other tested capillary tube .since all other refrigerant have different phenomena ,this due to if the refrigerating effect have more value than compressor work likelihood of COP increase , and the opposite likelihood of COP decrease.

Table 2 shows a summary of the whole experimental data.

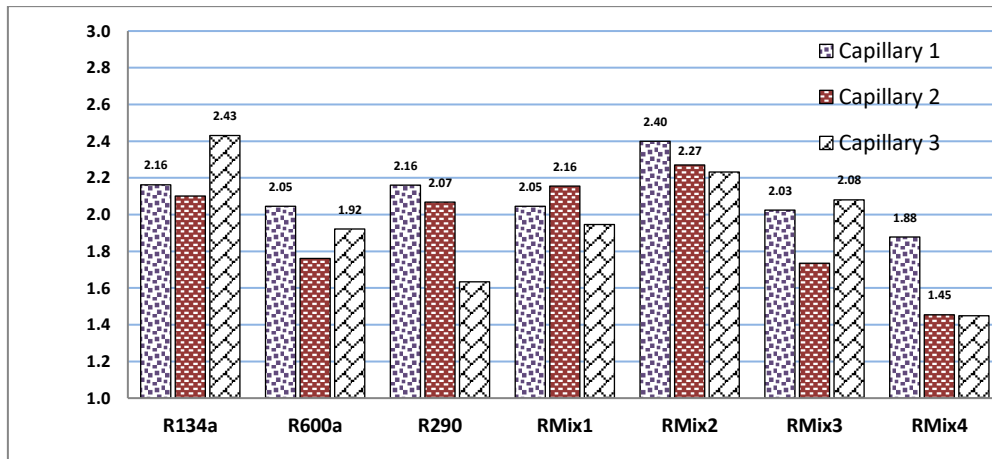

Fig. 8. COP Vs capillary tube diameter.

Table 2. Experimental data.

R134A						
Capillary	T1(°C)	T2(°C)	T3(°C)	T4(°C)	P1BAR	P2(BAR)
Capillary 1	8	67.8	49.8	1	2.3	15.7
Capillary 2	6	68.2	49	-2.7	2.1	14.9
Capillary 3	15	70	47	3.7	1.14	14.2
R600a						
Capillary 1	20	56	48	14	2.5	9.95
Capillary 2	22	63.3	46	14.7	2.6	12.5
Capillary 3	21	59	50	14.7	2.4	10.5
R290						
Capillary 1	13.6	54	32	-6	1.5	11
Capillary 2	11.9	53	30	-5.5	1.46	11
Capillary 3	19.5	62.5	36.4	14.5	1.19	10
RMix1						
Capillary 1	13.2	69.8	32.7	-8	1.1	22
Capillary 2	17.2	73.7	42.5	-11	1.15	23
Capillary 3	23.4	78.2	48.5	10	1	19
RMix2						
Capillary 1	23	73.9	45.4	-4.4	1.1	24
Capillary 2	13	64.7	33.8	-8	1.1	19
Capillary 3	18.8	70.3	45.2	-1	1.2	15.5
RMix3						
Capillary 1	4.5	54.8	41.7	-11	1.15	23
Capillary 2	1.5	56	42.8	-7.5	1.2	23
Capillary 3	7.5	52	45.7	2.5	1.33	20
RMix4						
Capillary 1	13.6	64	52	9	1.4	23
Capillary 2	4	68.1	52.1	-1	1.2	28
Capillary 3	4.5	69.9	52	-2.5	1.23	27

5. CONCLUSION:

In the light of the preceding results of experimental work, the following conclusions can be draw:

1. The refrigerator with small tube diameter required more work due to more pressure drop and pressure ratio.
2. The refrigerating effect for refrigerator work with R134a and RMix3 is increased as the capillary tube diameter increasing. Due to the amount of flashing gas reducing at evaporator inlet.
3. For refrigerant R134a, R600a and RMix3 the refrigerator that performed with capillary tube 2 have less COP as compared with other tested capillary tube.
4. The refrigerator that operate with RMix2 and capillary tube1 have COP more close to that of base case ;and can be selected as the best alternative selection for R134a .

6. REFERENCES:

ASHRE, Refrigeration (1998). Chaper 45.

Ali, I. M. and Jasim, A. H. (2005). An Experimental Study of Capillary Tubes Behavior With R-12 and R-134a. *Al-Khwarizmi Engineering Journal*, 1 (1), pp. 73-82.

Poolkrajang, A. and Preamjai, N. (2009). Optimization of Capillary Tube in Air Conditioning System. *Asian Journal on Energy and Environment*, 10 (3), pp. 165-175.

Salim, T. K. (2012).The Effect of the Capillary Tube Coil Number on the Refrigeration System Performance. *Tikrit Journal of Engineering Sciences*, 19 (2), pp. 18-29

Matani, A. G. and Agrawal, M. K. (2013). Effect of Capillary Diameter on the Performance of VCRS Using R134a, HC Mixture and R401a as Working Medium. *International Journal of Application or Innovation in Engineering & Management*, 2(3),pp. 106-115.

Pathak, S. S., Shukla, P., Chauhan S., and Srivastava, A. K. (2014). An experimental study of the Effect of capillary tube diameter and configuration on the performance of a simple vapour compression refrigeration system. *Journal of Mechanical and Civil Engineering*, 11(3), pp. 101-113.

Abed, A. R., Fadhiel, H. J., Mahsun, G., and Yassen T. C. (2014). Experimental Study on the Effect of Capillary Tube Geometry on the Performance of Vapour Compression Refrigeration System. *Diyala Journal of Engineering Sciences*, 7(2), pp.47-60.

Farayibi, P.K., Mogaji, T.S., and Erinle, T. J. (2016). Effect of Throttling Variation on the Performance of Vapour Compression Refrigeration System. *British Journal of Applied Science & Technology*, 13(5), pp. 1-10.

Ballaney, P. (2012). *Refrigeration and Airconditioning*. 15th ed. Nai Sarak Delhi, India: Khanna Publishers.

Borgnakke, C. and Sonntag, R. (2012). *Fundamentals of Thermodynamics*. 8th ed. Wiley.