

## Analysis of Fibrous Reinforced Concrete Beams

**Dr. Mereen Hassan Fahmi Rasheed**

Technology College, Foundation of Technical Technology of Erbil/ Erbil

E-mail: [mereen\\_akrawi@yahoo.com](mailto:mereen_akrawi@yahoo.com)

**Dr. Ayad Zeki Saber Agha**

Technology College, Foundation of Technical Technology of Erbil/ Erbil

Email: [agha-ayad@yahoo.com](mailto:agha-ayad@yahoo.com)

Received on: 23/3/2011 & Accepted on: 3/11/2011

### ABSTRACT

Steel fiber reinforced concrete is used as a construction material in modern structures. Recent studies have shown that steel fiber can be used to improve the behavior of structures and increase the bending moment capacity and shear strength of reinforced concrete members.

This research present and modify the nominal and ultimate bending moment equation, maximum and balance reinforcement indices and depth of compression zone for different types of reinforced concrete beams: single, double and T beams including the effect of steel fibers.

The modified equations showed that the internal moment capacity of the beams with steel fiber increased by the amount ( $M_{fiber}$ ) which represent the participation of the steel fiber. The balance and maximum reinforced indexes ( $\rho_b$  &  $\rho_{max}$ ) decreased by ( $\rho_{fiber}$ ) for single, double & T-beam reinforced concrete, this means that the ductility increased by adding steel fiber. Also the depth of compression zone increased by a factor ( $\lambda$ ) which is greater than (1.0). The modified equations are verified and applied on the reinforced concrete beams with steel fibers which tested in previous study, the theoretical results showed excellent agreement with the experimental values.

**Keywords:** Single reinforced concrete beam, Double reinforced concrete beam, T beam, Steel fiber, Bending moment and Reinforcement index.

### تحليل العتبات الخرسانية المسلحة والمعززة بالالياف الفولاذية

الخلاصة

الخرسانة المسلحة والمعززة بالالياف الفولاذية يمكن استخدامها كمادة أنشائية في المنشآت الحديثة. وتوضح الدراسات بأن الالياف الفولاذية يمكن استخدامها لتحسين خواص المنشآت وزيادة مقاومة العزم الاقصى ومقاومة القص للاعضاء الخرسانية المسلحة.

يقدم هذا البحث معادلات أيجاد مقاومة العزم الاقصى ونسبة التسليح الحرج والاكبر و عمق الخرسانة تحت الضغط للعتبات الخرسانية أحادية التسليح، ثنائية التسليح و عتبات على شكل (T) وأدخال تأثير الالياف الفولاذية.

المعادلات المعدلة اظهرت بان مقاومة العزم الاقصى الداخلي للعتبات الخرسانية المعززة بالالياف الفولاذية ازدادت بمقدار ( $M_{fiber}$ ) والتي تمثل مساهمة الالياف الفولاذية. نسبة التسليح الحرج والاقصى ( $\rho_b$  &  $\rho_{max}$ ) قلت بمقدار ( $\rho_{fiber}$ ) للعتبات ( الاحادية، المزدوجة وعلى شكل T) الخرسانية المسلحة. وهذا يعني زيادة استطالة العتبات الخرسانية باضافة الالياف الفولاذية. وكذلك فان عمق منطقة الانضغاط في مقطع العتبة الخرسانية المعززة بالالياف الفولاذية ازدادت بمقدار المعامل ( $\lambda$ ) وقيمتها اكبر من واحد. تم اختبار المعادلات المعدلة بتطبيقها على العتبات الخرسانية المعززة بالالياف الفولاذية لدراسة سابقة واطهرت النتائج النظرية تطابقا جيدا مع المعطيات العملية.

## INTRODUCTION

Steel fiber reinforced concrete is increasingly used as a construction material and it's a concrete made of cement with aggregate and steel bars with addition of steel fibers. Steel fiber reinforced concrete has been used in many applications such as bridges and high way paving [(Hoff,1986),( Johnston,1984),(Ramakrishnan et al.,1990)].

(Ezeldin et al.,1992), presented a computer algorithm that analyze the effective simultaneous contribution of steel fibers to bending and shear strengths of reinforced fiber concrete beams in an attempt to optimize the use of different materials (cement, steel fibers, reinforcing bars and stirrups). The algorithm conducts a systematic direct search in the space of six variables (beam width, beam depth, fiber content, bending reinforcing bars, shear stirrups and stirrup spacing to yield an optimum solution for a given cost objective function. The algorithm can simply the combined used of concrete, conventional reinforcement and steel fibers as construction materials.

(Lim et al.,1987), reported an analytical and experimental investigation into the moment – curvature and load – deflection characteristics of steel fiber concrete. Explicit expression were given for the modulus of elasticity, tensile and compressive stress – strain behavior of the composite. Analytically predicted curves are found to agree well with those obtained from experiments conducted on two series of mixes. This approach serves as a useful tool to predict flexural strength and to quantify the toughness of the material using available indexes.

(Swamy et al.,1981), presented an experimental study on the influence of fiber reinforcement on the deformation characteristics and ultimate strength in flexure. Tests showed that while ultimate strength is increased, the fibers arrest advancing cracks and increase post cracking stiffness at all stages of loading up to failure which results in narrower crack widths and less deformation. Also the concrete compressive strain reaches values of (0.005 to 0.006) at failure. The tests reported by (Swamy et al.,1975) showed that the presence of steel fibers enables high strength steel bars with yield strength (700 MPa) to be used with both cracks width and deflection being controlled to acceptable limits. The tests showed that at failure the concrete compressive strain reached values of 0.005 to 0.006 and the steel fiber attained stresses well in excess of their yield strengths.

(Aziz et al.,2002), developed an analytic expression for the stress-strain relationship for normal weight fibrous concrete. A simple expression technique was used to obtain the stress-strain curves of the normal weight fibrous concrete, also they obtained

empirical expressions to predict the ultimate strain of concrete and block stress parameters for different values of steel fiber content as shown below:

$$\epsilon_{uf} = 0.003 + 0.008 \left( \frac{Q_f \cdot L_f}{D_f} \right) \dots\dots (1)$$

$$\gamma_f = 0.85 + 0.02 \left( \frac{Q_f \cdot L_f}{D_f} \right) \dots\dots (2)$$

$$\beta_f = 0.85 + 0.03 \left( \frac{Q_f \cdot L_f}{D_f} \right) \text{ for } f'_c < 27.58 \text{ MPa} \dots\dots(3)$$

$$\beta_f = 0.85 + 0.03 \left( \frac{Q_f \cdot L_f}{D_f} \right) - 0.05 \left( 1 - 0.25 \frac{Q_f \cdot L_f}{D_f} \right) (f'_c - 27.58) / 6.89 \dots\dots(4)$$

For

$$55.2 > f'_c > 27.58 \text{ MPa}$$

$$\beta_f = 0.65 \text{ for } f'_c > 55.2 \text{ MPa} \dots\dots(5)$$

Where:

$Q_f$  = Volume fraction of steel fiber (%).

$\frac{L_f}{D_f}$  = Aspect ratio of steel fiber.

$L_f$  = Length of steel fiber (mm).

$D_f$  = Diameter of steel fiber (mm).

Different types of steel fibers are used, such as, asbestos, steel, carbon, glass, polypropylene and polyethylene fibers (ACI – Committee 544,1993 and 1996), the most common type used with concrete is the steel fiber which is improved the properties of the concrete.

The tensile strength of plain concrete with steel fiber can be calculated from the following equation [(Hanant,1978),(Swamy et al.,1974)]:

$$\sigma_{fu} = 0.82 \tau F \dots\dots (6)$$

Where:

$\tau$  = Interfacial bond strength between the steel fiber and concrete matrix.

$F$  = Fiber factor [(Narayanan et al.,1984),(Narayanan et al.,1985)].

$$= Q_f \cdot d_f \frac{L_f}{D_f} \dots\dots(7)$$

$d_f$  = Bond factor depends on the type of steel fiber.

(Kumar,2004), presented an analytical study on ultimate shear strength of fibrous reinforced concrete corbels without shear reinforcement and tested under vertical loading. Semi-empirical equations developed based on available data to estimate the shear strength and effect of fiber reinforcement on the ductility of shear failure.

(Balaguru et al.,1992), used a relatively new procedure to measure the deflections of the flexural behavior of steel fiber reinforced concrete. The results indicate that using of steel fiber provides excellent ductility for normal and high strength concrete, also hooked end fiber geometry provides better results than corrugated and deformedend fibers.

**Theory and Analysis**

**Singly reinforced concrete beams**

From the horizontal equilibrium for stress diagram shown in Fig. (1). The depth of equivalent compression zone is obtained:

$$a_f = \left( \frac{A_s \cdot f_y}{b} + \sigma_{fu} \cdot h \right) / \left( \gamma_f \cdot f'_c + \frac{\sigma_{fu}}{\beta_f} \right) \dots\dots(8)$$

if  $\sigma_{fu}=0$ , the above equation return to the same equation of beams without steel fiber.

$$a = A_s \cdot f_y / (\gamma_f \cdot f'_c \cdot b) \dots\dots\dots (9)$$

Where:

- $\sigma_{fu}$ = Tensile strength of fibrous concrete.
  - $f'_c$ = Compressive strength of concrete (MPa).
  - $f_y$ = Yield strength of steel bar (MPa).
  - $a$ = Depth of equivalent compression zone (mm).
  - $a_f$ = Depth of equivalent compression zone for fibrous concrete (mm).
  - $b$ = Total width of the member (mm).
  - $h$ = Total depth of the member (mm).
  - $A_s$ = Area of steel reinforcement in tension (mm<sup>2</sup>).
- Equation (8) can be written in another form:

$$a_f = a \cdot \lambda \dots\dots\dots (10)$$

where:

$$\lambda = \frac{\left[ 1 + \frac{\sigma_{fu} \cdot b \cdot h}{A_s \cdot f_y} \right]}{\left[ 1 + \frac{\sigma_{fu}}{\gamma_f \cdot \beta_f \cdot f'_c} \right]} \dots\dots\dots (11)$$

The above equation shows that the depth of equivalent rectangular stress distribution in compression for fibrous concrete beams is increased by a factor ( $\lambda$ ). Fig.(2) shows the relation between the fiber factor ( $F$ ) versus ( $\lambda=a_f / a$ ).

The nominal flexural bending moment can be written as:

$$M_{nf} = A_s \cdot f_s \left( d - \frac{a_f}{2} \right) + \sigma_{fu} \cdot b \left( h - \frac{a_f}{\beta_f} \right) \left( \frac{h}{2} - \frac{a_f}{2} + \frac{a_f}{2\beta_f} \right) \dots\dots(12)$$

The above equation can be written in another form:

$$M_{nf} = A_s \cdot f_s \left( d - \frac{a_f}{2} \right) + \frac{\sigma_{fu} \cdot a_f^2 \cdot b}{2\beta_f^2} \cdot \left( \frac{\beta_f \cdot h}{a_f} - 1 \right) \left( \frac{\beta_f \cdot h}{a_f} - \beta_f + 1 \right) \dots \dots (13)$$

Or:

$$M_{nf} = M_n + M_{fiber} \dots \dots (14)$$

$$M_n = A_s \cdot f_s \left( d - \frac{a_f}{2} \right)$$

$$M_{fiber} = \frac{\sigma_{fu} \cdot a_f^2 \cdot b}{2\beta_f^2} \left( \frac{\beta_f \cdot h}{a_f} - 1 \right) \left( \frac{\beta_f \cdot h}{a_f} - \beta_f + 1 \right)$$

Where:

$M_n$  = Nominal Bending moment (N.mm).

$M_{nf}$  = Nominal Bending moment for fibrous concrete (N.mm).

$M_{fiber}$  = Nominal Bending moment contribution of steel fibers (N.mm).

For ductile (tension) failure, the steel stress ( $f_s$ ) replaced by ( $f_y$ ).

The first term represents the nominal bending moment capacity of ordinary reinforcement concrete and the second term represents the participation of steel fibers. Fig.(3) shows the contribution of steel fiber in the internal flexural capacity of the beam.

To provide ductile failure, the beam should be reinforced with an amount less than the balance or maximum amount(Nilson,2004), i.e. reinforcement index ( $\rho$ ) less than maximum ( $\rho_{max}$ ) or balance reinforcement index ( $\rho_b$ )

Balance reinforcement index can be determined by applying the equilibrium equation and strain compatibility condition as following:

$$c_b = \left( \frac{\epsilon_u}{\epsilon_u + \epsilon_y} \right) d \dots \dots (15)$$

$$a_b = \left( \frac{\beta_f \cdot \epsilon_u}{\epsilon_u + \epsilon_y} \right) d \dots \dots (16)$$

equating equations (8 and 16) and taking ( $\rho = A_s/bd$ ):

$$\rho_{bf} = \left( \frac{\gamma_f \cdot \beta_f \cdot f'_c + \sigma_{fu}}{f_y} \right) \left( \frac{\epsilon_u}{\epsilon_u + \epsilon_y} \right) - \frac{\sigma_{fu} \cdot h}{f_y \cdot d} \dots (17)$$

Applying more simplifications:

$$\rho_{bf} = \frac{\gamma_f \beta_f f'_c}{f_y} \left( \frac{\epsilon_u}{\epsilon_u + \epsilon_y} \right) - \frac{\sigma_{fu}}{f_y} \left[ \frac{h}{d} - \frac{\epsilon_u}{\epsilon_u + \epsilon_y} \right] \dots (18)$$

Or:

$$\rho_{bf} = \rho_b - \rho_{fiber} \dots \dots (19)$$

$$\rho_{maxf} = \rho_{max} - \rho_{fiber} \dots \dots (20)$$

Where:

$$\rho_b = \frac{\gamma_f \beta_f f'_c}{f_y} \left( \frac{\epsilon_u}{\epsilon_u + \epsilon_y} \right)$$

$$\rho_{fiber} = \frac{\sigma_{fu}}{f_y} \left[ \frac{h}{d} - \frac{\epsilon_u}{\epsilon_u + \epsilon_y} \right]$$

The first term represents reinforcement index of ordinary reinforced concrete and the second term represents the contribution of steel fiber.

Where:

$\epsilon_u$  = Ultimate strain of plain concrete.

$\epsilon_y$  = Yield strain of steel bar.

$a_b$  = Depth of equivalent compression zone in balance condition (mm).

$c_b$  = Depth of compression zone in balance condition (mm).

$\rho$  = Reinforcement index of tension reinforcement.

$\rho_b$  = Balance reinforcement index.

$\rho_{max}$  = Maximum reinforcement index.

$\rho_{bf}$  = Balance reinforcement index for fibrous concrete beams.

$\rho_{maxf}$  = Maximum reinforcement index for fibrous concrete beams.

$\rho_{fiber}$  = Reinforcement index of steel fiber.

Fig.(4) shows the relation of Fiber factor ( $F$ ) versus the ratio ( $\rho_{bf}/\rho_b$ ), the value of ( $\rho_{bf}$ ) is reduced with increasing of ( $F$ ) this means that the addition of steel fibers increase the ductility of the beams.

### DOUBLY REINFORCED CONCRETE BEAMS

From the horizontal equilibrium for stress diagram shown in Fig. (5).

The depth of equivalent compression zone is obtained:

$$a_f = \beta_f [A_s \cdot f_s - A'_s \cdot f'_s + \sigma_{fu} \cdot b \cdot h] / [(\gamma_f \cdot \beta_f \cdot f'_c + \sigma_{fu}) b] \quad \dots\dots (21)$$

In case  $f_s = f'_s = f_y$  and taking ( $\rho = A_s/bd$ ) and ( $\rho' = A'_s/bd$ )

$$a_f = \beta_f [(\rho - \rho') f_y \cdot d + \sigma_{fu} \cdot h] / [\gamma_f \cdot \beta_f \cdot f'_c + \sigma_{fu}] \quad \dots\dots (22)$$

Or in simpler form:

$$a_f = a \cdot \lambda \quad \dots\dots (23)$$

where:

$$a = (\rho - \rho') f_y d / (\gamma_f \cdot f'_c)$$

$$\lambda = \frac{[1 + \frac{\sigma_{fu} \cdot h}{(\rho - \rho') f_y d}]}{[1 + \frac{\sigma_{fu}}{\gamma_f \cdot \beta_f \cdot f'_c}]}$$

Where:

$A'_s$  = Area of steel reinforcement in compression (mm<sup>2</sup>).

$f_s$  = Stress in tension steel bar (MPa).

$f'_s$  = Stress in compression steel bar (MPa).

$\rho'$  = Reinforcement index of compression reinforcement.

The nominal bending moment for doubly reinforced concrete beams with steel fiber can be written as:

$$M_{nf} = A'_s \cdot f'_s (d - d') + \left( A_s - \frac{A'_s \cdot f'_s}{f_s} \right) f_s \left( d - \frac{a_f}{2} \right) + \sigma_{fu} \cdot b \left( h - \frac{a_f}{\beta_f} \right) \left( \frac{h}{2} - \frac{a_f}{2} + \frac{a_f}{2\beta_f} \right) \dots \dots \dots (24)$$

The above equation can be written in another form:

$$M_{nf} = A'_s \cdot f'_s (d - d') + \left( A_s - \frac{A'_s \cdot f'_s}{f_s} \right) f_s \left( d - \frac{a_f}{2} \right) + \frac{\sigma_{fu} \cdot a_f^2 \cdot b}{2\beta_f^2} \left( \frac{\beta_f \cdot h}{a_f} - 1 \right) \left( \frac{\beta_f \cdot h}{a_f} - \beta_f + 1 \right) \dots \dots (25)$$

Or Similarly as in singly reinforced concrete beams:

$$M_{nf} = M_n + M_{fiber} \dots \dots (26)$$

Where:

$$M_n = A'_s \cdot f'_s (d - d') + \left( A_s - \frac{A'_s \cdot f'_s}{f_s} \right) f_s \left( d - \frac{a_f}{2} \right)$$

$$M_{fiber} = \frac{\sigma_{fu} \cdot a_f^2 \cdot b}{2\beta_f^2} \left( \frac{\beta_f \cdot h}{a_f} - 1 \right) \left( \frac{\beta_f \cdot h}{a_f} - \beta_f + 1 \right)$$

$d'$  = Distance from the top surface to the center of compression bar (mm).

In ductile (tension) condition replacing  $f_s$  and  $f'_s$  by  $f_y$  in above equations.

By the same previous procedures that explained in singly reinforced concrete beams, the equations to determine balance and maximum reinforcement indexes are shown below:

$$\rho'_{bf} = \frac{\gamma_f \beta_f f'_c}{f_y} \left( \frac{\epsilon_u}{\epsilon_u + \epsilon_y} \right) + \frac{\rho' f'_s}{f_y} - \frac{\sigma_{fu}}{f_y} \left[ \frac{h}{d} - \frac{\epsilon_u}{\epsilon_u + \epsilon_y} \right] \dots \dots \dots (27)$$

or in simpler form:

$$\rho'_{bf} = \rho'_b - \rho_{fiber} \dots \dots \dots (28)$$

$$\rho'_{maxf} = \rho'_{max} - \rho_{fiber} \dots \dots \dots (29)$$

Where:

$$\rho'_b = \frac{\gamma_f \beta_f f'_c}{f_y} \left( \frac{\epsilon_u}{\epsilon_u + \epsilon_y} \right) + \frac{\rho' f'_s}{f_y}$$

$$\rho_{fiber} = \frac{\sigma_{fu}}{f_y} \left[ \frac{h}{d} - \frac{\epsilon_u}{\epsilon_u + \epsilon_y} \right]$$

$\rho'_{bf}$  = Balance reinforcement index for doubly reinforced concrete beams with steel fiber.

$\rho'_b$  = Balance reinforcement index for doubly reinforced concrete beams.

$\rho'_{maxf}$  = Maximum reinforcement index for doubly reinforced concrete beams with steel fiber.

$\rho'_{max}$  = Maximum reinforcement index for doubly reinforced concrete beams.

The limiting reinforcement index for compression reinforcement ( $\rho'_{cy}$ ) is derived by using the compatibility equation:

$$c_b = \left( \frac{\epsilon_u}{\epsilon_u + \epsilon_y} \right) d' \quad \dots\dots\dots (30)$$

$$a_b = \left( \frac{\beta_f \cdot \epsilon_u}{\epsilon_u + \epsilon_y} \right) d' \quad \dots\dots\dots (31)$$

equating equations (8 and 31), after some elimination simplification procedures:

$$\rho'_{cyf} = \frac{\gamma_f \beta_f f'_c}{f_y} \cdot \frac{d'}{d} \cdot \left( \frac{\epsilon_u}{\epsilon_u - \epsilon_y} \right) + \frac{\rho' f'_s}{f_y} - \frac{\sigma_{fu}}{f_y} \left[ \frac{h}{d} - \left( \frac{\epsilon_u}{\epsilon_u - \epsilon_y} \right) \left( \frac{d'}{d} \right) \right] \dots (32)$$

Or in simpler form:

$$\rho'_{cyf} = \rho'_{cy} - \rho'_{fiber} \quad \dots\dots\dots (33)$$

Where:

$$\rho'_{cy} = \frac{\gamma_f \beta_f f'_c}{f_y} \cdot \frac{d'}{d} \cdot \left( \frac{\epsilon_u}{\epsilon_u - \epsilon_y} \right) + \frac{\rho' f'_s}{f_y}$$

$$\rho'_{fiber} = \frac{\sigma_{fu}}{f_y} \left[ \frac{h}{d} - \left( \frac{\epsilon_u}{\epsilon_u - \epsilon_y} \right) \left( \frac{d'}{d} \right) \right]$$

$\rho'_{cyf}$  = Limit reinforcement index for doubly reinforced concrete beams with steel fiber.

$\rho'_{cy}$  = Limit reinforcement index for doubly reinforced concrete beams.

$\rho'_{fiber}$  = Reinforcement index of steel fiber for doubly reinforced concrete beams.

**REINFORCED CONCRETE T – BEAMS**

From the horizontal equilibrium for stress diagram shown in Fig.(6).the depth of equivalent compression zone is obtained:

$$a_f = \frac{\beta_f [(A_s - A_{sf}) f_s + \sigma_{fu} \cdot b_w \cdot h]}{(\gamma_f \cdot \beta_f \cdot f'_c + \sigma_{fu}) b_w} \quad \dots\dots\dots (34)$$

In case  $f_s = f'_s = f_y$  and taking  $(\rho = A_s/bd)$  and  $(\rho_f = A_{sf}/bd)$



$$a_f = \frac{\beta_f[(\rho - \rho_f) f_y \cdot d + \sigma_{fu} \cdot h]}{(\gamma_f \cdot \beta_f \cdot f'_c + \sigma_{fu})} \dots\dots\dots (35)$$

Or in simpler form:

$$a_f = a \cdot \lambda \dots\dots\dots (36)$$

where:

$$a = \frac{(\rho - \rho_f) f_y \cdot d}{\gamma_f \cdot f'_c}$$

$$\lambda = \frac{[1 + \frac{\sigma_{fu} \cdot h}{(\rho - \rho_f) f_y \cdot d}]}{[1 + \frac{\sigma_{fu}}{\gamma_f \cdot \beta_f \cdot f'_c}]}$$

The nominal bending moment for doubly reinforced concrete beams with steel fiber can be written as:

$$M_{nf} = A_{sf} \cdot f_s (d - h_f/2) + (A_s - A_{sf}) f_s (d - \frac{a_f}{2}) + \sigma_{fu} \cdot b_w (h - \frac{a_f}{\beta_f}) (\frac{h}{2} - \frac{a_f}{2} + \frac{a_f}{2\beta_f}) \dots\dots\dots (37)$$

The above equation can be written in another form:

$$M_{nf} = A_{sf} \cdot f_s (d - h_f/2) + (A_s - A_{sf}) f_s (d - \frac{a_f}{2}) + \frac{\sigma_{fu} \cdot a_f^2 \cdot b_w}{2\beta_f^2} (\frac{\beta_f \cdot h}{a_f} - 1) (\frac{\beta_f \cdot h}{a_f} - \beta_f + 1) \dots\dots\dots (38)$$

Similarly as in singly reinforced concrete beams:

$$M_{nf} = M_n + M_{fiber} \dots\dots\dots (39)$$

Where:

$$M_n = A_{sf} \cdot f_s (d - \frac{h_f}{2}) + (A_s - A_{sf}) f_s (d - \frac{a_f}{2})$$

$$M_{fiber} = \frac{\sigma_{fu} \cdot a_f^2 \cdot b_w}{2\beta_f^2} (\frac{\beta_f \cdot h}{a_f} - 1) (\frac{\beta_f \cdot h}{a_f} - \beta_f + 1)$$

$h_f$  = Thickness of the slab (mm).

By the same previous procedures that explained in singly reinforced concrete beams, the equations to determine balance and maximum reinforcement indexes are shown below:

$$\rho_{bwf} = \rho_{bw} - \rho_{fiber} \quad \dots(40)$$

Where:

$$\rho_{bw} = \frac{\gamma_f \beta_f f'_c}{f_y} \left( \frac{\epsilon_u}{\epsilon_u + \epsilon_y} \right) + \rho_f$$

$$\rho_{fiber} = \frac{\sigma_{fu}}{f_y} \left[ \frac{h}{d} - \frac{\epsilon_u}{\epsilon_u + \epsilon_y} \right]$$

$$\rho_f = \frac{A_{sf}}{b_w d}$$

$$A_{sf} = \frac{\gamma_f \cdot f'_c \cdot h_f (b - b_w)}{f_y}$$

$\rho_{bwf}$  = Balance reinforcement index for fibrous concrete T beams.

$\rho_{bw}$  = Balance reinforcement index for ordinary concrete T beams.

### Doubly reinforced concrete T – beams

The following equations are derived for doubly reinforced concrete T beams with steel fibers by using the same procedures.

$$a_f = a \cdot \lambda \quad \dots\dots\dots(41)$$

where:

$$a = \frac{(\rho - \rho_f - \rho') f_y \cdot d}{\gamma_f \cdot f'_c}$$

$$\lambda = \frac{\left[ 1 + \frac{\sigma_{fu} \cdot h}{(\rho - \rho_f - \rho') f_y \cdot d} \right]}{\left[ 1 + \frac{\sigma_{fu}}{\gamma_f \cdot \beta_f \cdot f'_c} \right]}$$

$$M_{nf} = M_n + M_{fiber} \quad \dots(42)$$

Where:

$$M_n = A_{sf} \cdot f_s \left( d - h_f / 2 \right) + A'_s \cdot f'_s \left( d - d' \right) + \left( A_s - A_{sf} - A'_s \frac{f'_s}{f_s} \right) f_s \left( d - \frac{a_f}{2} \right)$$

$$M_{fiber} = \frac{\sigma_{fu} \cdot a_f^2 \cdot b_w}{2\beta_f^2} \left( \frac{\beta_f \cdot h}{a_f} - 1 \right) \left( \frac{\beta_f \cdot h}{a_f} - \beta_f + 1 \right)$$

$$\rho'_{bwf} = \rho'_{bw} - \rho_{fiber} \quad \dots\dots\dots (43)$$

Where:

$$\rho'_{bw} = \frac{\gamma_f \beta_f f'_c}{f_y} \left( \frac{\epsilon_u}{\epsilon_u + \epsilon_y} \right) + \rho_f + \frac{\rho' \cdot f'_s}{f_y}$$

$$\rho_{fiber} = \frac{\sigma_{fu}}{f_y} \left[ \frac{h}{d} - \frac{\epsilon_u}{\epsilon_u + \epsilon_y} \right]$$

$$\rho'_{cy,wf} = \rho'_{cy,w} - \rho'_{fiber} \quad \dots\dots\dots(44)$$

Where:

$$\rho'_{cy,w} = \frac{\gamma_f \beta_f f'_c}{f_y} \frac{d'}{d} \left( \frac{\epsilon_u}{\epsilon_u - \epsilon_y} \right) + \rho_f \frac{\rho' \cdot f'_s}{f_y}$$

$$\rho'_{fiber} = \frac{\sigma_{fu}}{f_y} \left[ \frac{h}{d} - \left( \frac{\epsilon_u}{\epsilon_u - \epsilon_y} \right) \left( \frac{d'}{d} \right) \right]$$

The theoretical equations which are derived in previous sections are verified and applied on three beams which are experimentally tested in ref (swamy et al. 1981), the details of reinforcement and cross section of the beams are shown in Fig.(7). The theoretical bending moment showed excellent agreement with the experimental value as shown in table below.

Beam	$M_{test}$ KN.m	$M_{theory}$ KN.m	Ratio
DR12	23.81	23.82	1.0004
DR22	35.06	34.187	0.975
DR32	30.83	29.55	0.96

## CONCLUSIONS

This study presents the strength equations for different types of reinforced concrete beams (singly reinforced, doubly reinforced and T-beam) with steel fibers. The equations of nominal bending moment, depth of compression zone and reinforcement indexes are modified to include the effect of steel fibers. From the results the following conclusions are obtained.

1. Depth of compression zone ( $a$ ) for beams with steel fibers increased by a factor ( $\lambda$ ) which is increased parabolically with increasing of fiber factor ( $F$ ) as shown in Fig.(2).
2. The internal bending moment capacity of the beams increased by amount ( $M_{fiber}$ ) which represents the participation of steel fibers.
3. The results indicate that steel fibers has significant contribution in the internal strength of the beams as shown in Fig.(3).
4. The balance and maximum reinforcement indexes are decreased by amount ( $\rho_{fiber}$ ), this means that the ductility of the beams increased by using steel fibers. Fig.(4) shows that the ratio of ( $\rho_{bf}/\rho_f$ ) decreased with increasing the fiber factor ( $F$ ).
5. Theoretical ultimate bending moment taking into account the effect of steel fiber showed excellent agreement with the experimental data given in previous study.
6. For beam with steel fiber content (1%), the depth of compression zone ( $a$ ) increased by (42%), nominal bending moment increased by (32.5%) and balance reinforcement index decreased by (17.3%).

## NOTATIONS

$\sigma_{fu}$  = Tensile strength of fibrous concrete.

$\tau$  = Interfacial bond strength between the steel fiber and concrete matrix.

$F$  = Fiber factor.

$d_f$  = Bond factor depends on the type of steel fiber.

$Q_f$  = Volume fraction of steel fiber (%).

$\frac{L_f}{D_f}$  = Aspect ratio of steel fiber.

$L_f$  = Length of steel fiber (mm).

$D_f$  = Diameter of steel fiber (mm).

$f'_c$  = Compressive strength of concrete (MPa).

$f_y$  = Yield strength of steel bar (MPa).

$f_s$  = Stress in tension steel bar (MPa).

$f'_s$  = Stress in compression steel bar (MPa).

$\gamma_f$  and  $\beta_f$  = Stress block parameters.

$\varepsilon_{uf}$  = Ultimate strain of fibrous concrete.

$\varepsilon_u$  = Ultimate strain of plain concrete.

$a$  = Depth of equivalent compression zone (mm).

$a_b$  = Depth of equivalent compression zone in balance condition (mm).

- $a_f$  = Depth of equivalent compression zone for fibrous concrete (mm).  
 $c$  = Depth of compression zone (mm).  
 $c_b$  = Depth of compression zone in balance condition (mm).  
 $\varepsilon_s$  = Strain of steel bar in tension.  
 $\varepsilon'_s$  = Strain of steel bar in compression.  
 $\varepsilon_y$  = Yield strain of steel bar.  
 $d$  = Effective depth of the member (mm).  
 $d'$  = Distance from the top surface to the center of compression bar (mm).  
 $b$  = Total width of the member (mm).  
 $b_w$  = Width of the member web (mm).  
 $h$  = Total depth of the member (mm).  
 $A_s$  = Area of steel reinforcement in tension (mm<sup>2</sup>).  
 $A'_s$  = Area of steel reinforcement in compression (mm<sup>2</sup>).  
 $M_n$  = Nominal Bending moment (N.mm).  
 $M_{nf}$  = Nominal Bending moment for fibrous concrete (N.mm).  
 $M_{fiber}$  = Nominal Bending moment contribution of steel fibers (N.mm).  
 $\rho$  = Reinforcement index of tension reinforcement.  
 $\rho'$  = Reinforcement index of compression reinforcement.  
 $\rho_b$  = Balance reinforcement index.  
 $\rho_{max}$  = Maximum reinforcement index.  
 $\rho_{bf}$  = Balance reinforcement index for fibrous concrete beams.  
 $\rho_{maxf}$  = Maximum reinforcement index for fibrous concrete beams.  
 $\rho_{fiber}$  = Reinforcement index of steel fiber.  
 $\rho'_{fiber}$  = Reinforcement index of steel fiber for doubly reinforced concrete beams.  
 $\rho'_{cyf}$  = Limit reinforcement index for doubly reinforced concrete beams with steel fiber.  
 $\rho'_{cy}$  = Limit reinforcement index for doubly reinforced concrete beams.  
 $\rho'_b$  = Balance reinforcement index for doubly reinforced concrete beams.  
 $\rho'_{max}$  = Maximum reinforcement index for doubly reinforced concrete beams.  
 $\rho'_{bf}$  = Balance reinforcement index for doubly reinforced concrete beams with steel fiber.  
 $\rho'_{maxf}$  = Maximum reinforcement index for doubly reinforced concrete beams with steel fiber.  
 $h_f$  = Thickness of the slab (mm).  
 $\rho_{bwf}$  = Balance reinforcement index for fibrous concrete T beams.  
 $\rho_{bw}$  = Balance reinforcement index for ordinary concrete T beams.

**REFERENCES**

- [1] Hoff, G.C.,(1986): "Use of Steel Fiber Reinforced Concrete in Bridge Ducts and Pavements", Steel Fiber Concrete, Elsevier Applied Science Publishers Ltd., England, PP. 67-108.
- [2] Johnston, C.D.,(1984): "Steel Fiber Reinforced Concrete Pavements Trails", Concrete International Design and Construction, Vol. 6, No. 12, Dec., PP.39-43.
- [3] Ramakrishnan, V., Balaguru, P., Kastaneski, L. and Johnston, D.,(1990): "Field Performance of Fiber Reinforced Concrete High way Pavements", Proceedings of the First Materials Engineering Congress, Denver, Aug., PP. 903-912.
- [4] Ezeldin, A.S. and Hsu, C.T.T.,(1992): "Optimization of Reinforced Fibrous Concrete Beams", ACI Structural Journal, Jan.-Feb., Vol. 89, No. 1, Title no. 89-S12, PP. 106-114.
- [5] Lim, T.Y., Paramasivam, P. and Lee, S.L.,(1987): "Bending behavior of Steel Fiber Concrete Beams", ACI Structural Journal, Nov.-Dec., Title no. 84-S54, PP. 524-536.
- [6] Swamy, R.N. and Al-Ta'an, S.A.,(1981): "Deformation and Ultimate Strength in Flexure of Reinforced Concrete Beams Made with Steel Fiber Concrete", ACI Structural Journal, Sep.-Oct., Title no. 87-36, PP. 395-405.
- [7] Swamy, R.N. and Al-Noori, K.A.,(1975): "Flexural Behavior of Fiber Concrete with Conventional Steel Reinforcement", Proceedings, RILEM Symposium on Fiber Reinforced Cement and Concrete, London, Sep., The Construction Press Limited, Lancaster, PP. 187-196.
- [8] Aziz, O.Q. and Abdul-Ahad, R.B.,(2002): "Stress – Strain Curves of Fibrous Concrete in Compression", Journal of Zankoy Sulaimani, June, Vol.5, No. 2, Part A, PP. 9-16.
- [9] ACI – Committee 544,(1993): "Guide for Specifying, Proportioning, Mixing, Placing and Finishing Steel Fiber Reinforced Concrete", ACI Manual Journal, Jan.-Feb., Vol.90, No.1, PP.94-101.
- [10] ACI – Committee 544,(1996): "State of Art Report on Fiber Reinforced Concrete", ACI Manual, PP.411-452.
- [11] Hanant, D.J.,(1978): "Fiber Cements and Fiber Concretes", John Wiley and Sons Publication, New York, USA, 220p.
- [12] Swamy, R.N., Mangar, R.S. and Roa, K.C.U.S.,(1974): " The Mechanics of Fiber Reinforcement of Cement Materials", ACI, SP-44, Detroit, PP.1-28.
- [13] Narayanan, R. and Palanjian, A.S.K.,(1984): "Effect of Fiber Addition on Concrete Strength", Indian Concrete Journal, Vol.58, No.4, April, PP. 100-103.
- [14] Narayanan, R. and Palanjian, A.S.K.,(1985): "A Space Truss Model for Fiber Concrete Beams in Torsion", The Structural Engineer, Vol 63B, No.1, March, PP. 4-18.
- [15] Kumar, S.,(2004): "Shear Strength of Reinforced Steel Fibrous Concrete Corbels without Shear Reinforcement", IE(I) Journal, Vol. 85, Nov., PP.202-212.
- [16] Balaguru, P.N., Narahari, R. and Patel, M.,(1992): "Flexural Toughness of Steel Fiber Reinforced Concrete", ACI Material Journal, Nov.-Dec., Vol. 89, No. 6, PP. 541-545.

[17] Nilson, A.H., Darwin, D. and Dolan, C.W., (2004): "Design of Concrete Structures", 13<sup>th</sup> edition, McGraw-Hill Inc. 779p.

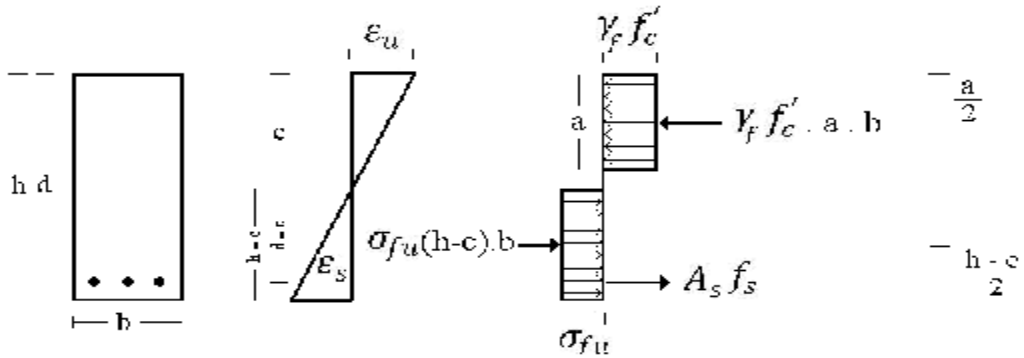

Figure (1): Stress and Strain distribution of Fibrous Singly R.C Beam

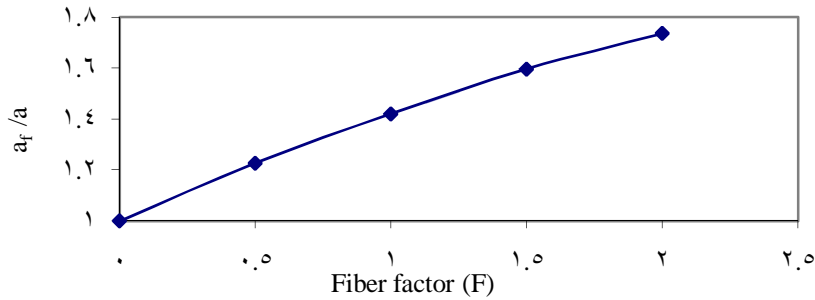

Figure (2): Relation between (  $a_f/a$  ) versus Fiber factor (F)

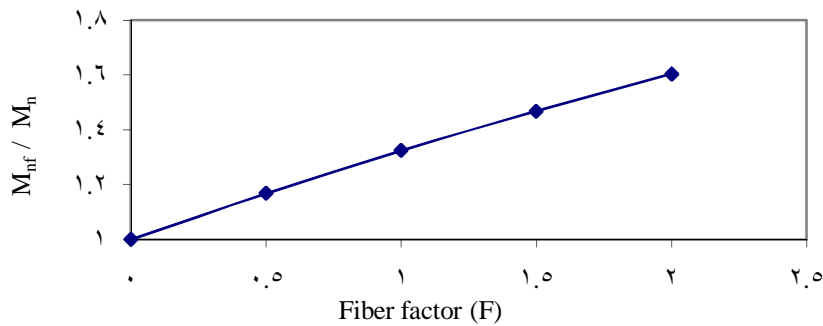

Figure (3): Relation between (  $M_{nf}/M_n$  ) versus Fiber factor (F)

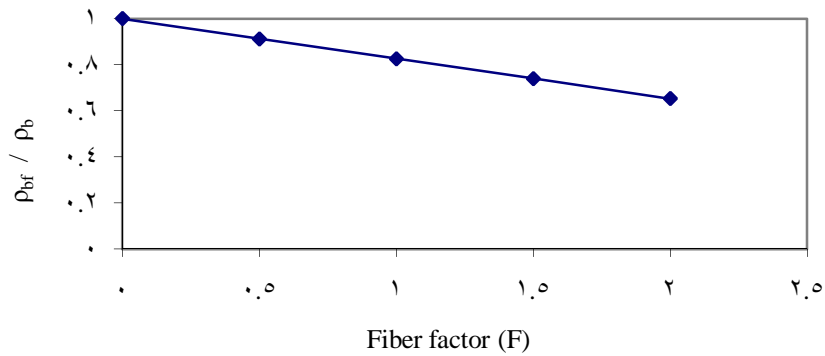
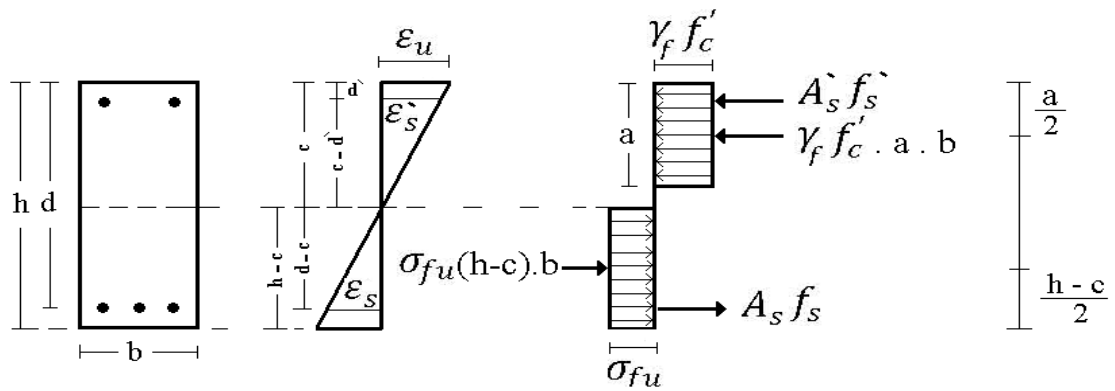

Figure (4): Relation between ( $\rho_{bf}/\rho_b$ ) versus Fiber factor (F)



Figure(5): Stress and Strain distribution of Fibrous Doubly R.C Beam

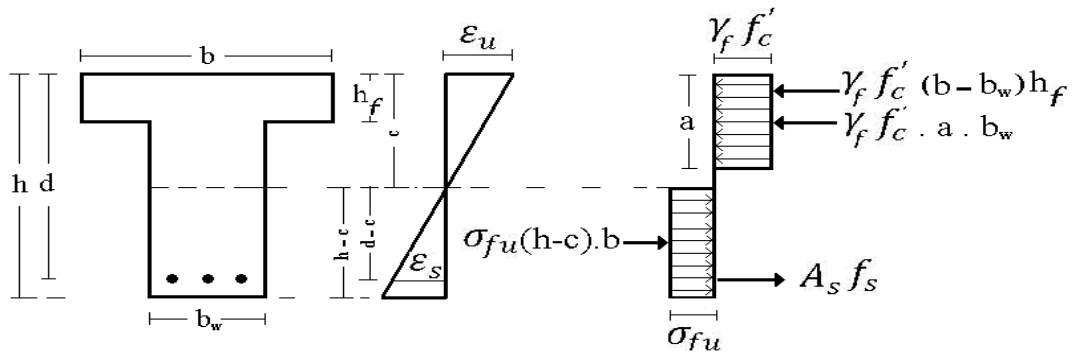

Figure (6): Stress and Strain distribution of Fibrous R.C.T Beam



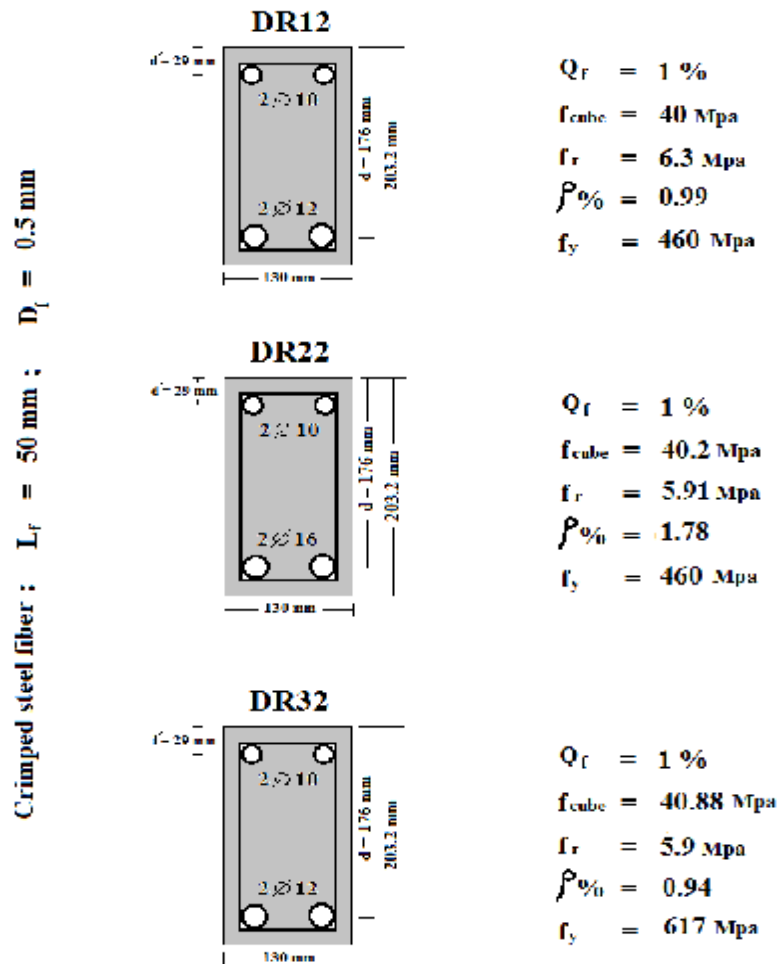
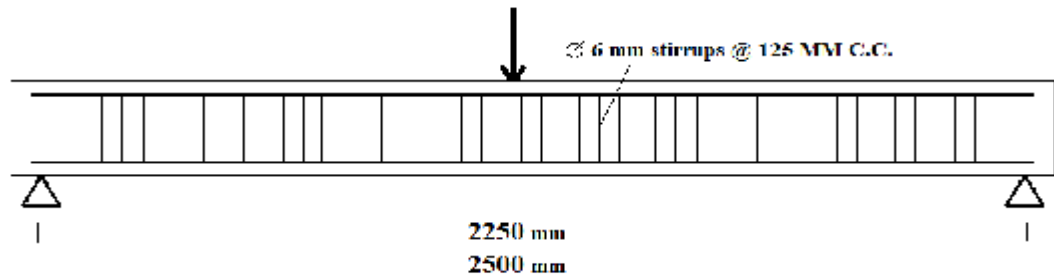

Figure (7): Details of the reinforcement and cross section of beams