

Microfiltration Membranes for Separating Oil / Water Emulsion

Ahmed Faiq Al-Alawy and Samah Mohsin Al – Musawi

Chemical Engineering Department – College of Engineering – University of Baghdad – Iraq

Abstract

This research was aimed to study the efficiency of microfiltration membranes for the treatment of oily wastewater and the factors affecting the performance of the microfiltration membranes experimental work were includes operating the microfiltration process using polypropylene membrane (1 micron) and ceramic membrane (0.5 micron) constructed as candle; two methods of operation were examined: dead end and cross flow. The oil emulsion was prepared using two types of oils: vegetable oil and motor oil (classic oil 20W-50). The operating parameters studied are: feed oil concentration 50 – 800 mg/l, feed flow rate 10 – 40 l/h, and temperature 30 – 50 °C, for dead end and cross flow microfiltration.

It was found that water flux decreases with increasing operating time and feed oil concentration and increases with increasing operating temperature, feed flow rate and pore size of membrane. Also, it was found that rejection percentage of oil increases with increasing flow rate and rejection percentage decreases with increasing time, feed oil concentration, feed temperature and pore size of membrane for dead end and cross flow microfiltration. In cross flow microfiltration, reject concentration (concentrate) increases with increasing flow rate, feed concentration, time and feed temperature. The dead end filter has more flux compared to cross flow filter, while, in cross flow the oil rejection percentage is best than dead end. Flux for vegetable oil is more than motor oil but rejection percentage for vegetable oil is less than that for motor oil. The highest recovery ratio was found is 44.8% for cross flow process with recirculation of concentrating stream to feed vessel. The highest rejection percentage of oil was found is 98 % and 97.8 % for cross flow and dead ends respectively.

Keywords: Membrane Separation; Microfiltration; Oil; Wastewater; Polypropylene Membranes; Ceramic Membrane

Introduction

Petroleum refineries and petrochemical plants all generate oily wastewater to some extent, and the oils contained in those wastewaters can vary widely. Removal of oils from wastewater is normally one of the first steps in the treatment of wastewater and arguably, the most important treatment step (Thomas, 2007). In

recent years, considerable attention has been focused on the discharge of oily wastewater and its impact on the environment. Pollution of water by oily hydrocarbons is especially harmful to the aquatic life, as it attenuates the light and perturbs the normal mechanism of oxygen transfer (Xianguo and Gyula, 2005, Nandi B.K 2010).

Typical oil concentrations from various industrial sources are: petroleum (10 – 7200 mg/l), Metals (100 – 5000 mg/l), food processing (14 – 10550 mg/l), wool (3000 – 20000 mg/l), textiles (20 – 12260 mg/l) and cooling and heating (7 – 1200 mg/l) (Syed, 2000). Iraqi requirements for the oil in the discharge water are 10 mg/l (Jassim, 2008). Various types of technologies exist for treatment of oily waters. These methods are gravity separators, dissolved air flotation, coalescers, biological treatment and activated carbon adsorption (Shams, et al., 2007).

Over the past several years, advances have been made in developing an industrial wastewater reclaim system for a separation process for oily industrial wastewater which is extremely effective and economical in recycling of aqueous parts washing solutions. This process is based on a membrane technology that has major technical and commercial advantages over other approaches that have been tried for this application (Mike and Ivan, 2008). Membrane separation technology has been around for many years. Initially, the use of membranes was isolated to a laboratory scale. However, improvements over the past twenty years have made it possible to use membranes on an industrial level. A membrane is simply a synthetic barrier, which prevents the transport of certain components based on various characteristics. Membranes are very diverse in their nature with the one unifying theme to separate. Membranes can be liquid or solid, homogeneous or heterogeneous and can range in thickness. They can be manufactured to be electrically neutral, positive, negative or bipolar. These different characteristics enable membranes to perform many different separations from reverse osmosis to microfiltration. Therefore pressure

driven membrane processes such as microfiltration (MF), ultrafiltration (UF), nanofiltration (NF) and reverse osmosis (RO) are increasingly being applied for treating oily wastewater (Syed, 2000).

Membranes have several advantages, among them: (Cheryan and Rajagopalan, 1998)

- The technology is more widely applicable across a wide range of industries.
- The membrane is a positive barrier to rejected components. Thus, the quality of the treated water is more uniform regardless of influent variations. These variations may decrease flux, but generally does not affect quality of its output.
- No extraneous chemicals are needed, making subsequent oil recovery easier.
- Membranes can be used in-process to allow recycling of selected waste streams within a plant.
- Membrane equipment has a smaller foot print.
- The plant can be highly automated and does not require highly skilled operators.

Microfiltration (MF) is filtration process that operation on a physical sieving separation process. It is best used for the removal of suspended solids, Giardia, Cryptosporidium and the reduction of turbidity. MF process require low trans membrane pressure (1–30 psi) to operate, and it is also used as a pretreatment to desalination technologies such as reverse osmosis, nanofiltration, and electrodialysis. MF membranes can operate in either cross flow separation or dead-end filtration. Cross flow separation is where only part of the feed stream is treated and the remainder of the water is passed through the membrane untreated. In dead-end separation, all of the feed water is treated. The microfiltration membrane can consist of various

materials like, for example, polysulfone, polypropylene, polyvinylidene fluoride (PVDF), polyethersulfone (PES), ZrO₂ and carbon (Peter, 2007). In this research study the efficiency of membrane separation process (MF) for oily wastewater treatment, and to achieve low content of oil in permeate and high permeate flux, effects of operating parameters such as oil concentration, temperature, feed flow rate, pore diameters of membranes, time, different types of membranes, different types of oils and methods of different operating (dead end and cross flow) in a microfiltration unit were studied. Simple filtration models have also been employed to help analyze the microfiltration membrane – fouling process.

Membrane Fouling Models

The permeation flux of particle-free water across a clean membrane can be described by Darcy's law as:

$$J = \frac{\Delta p}{\mu R_m} \quad \dots(1)$$

Where J ($\text{m}^3 \text{m}^{-2} \text{s}^{-1}$) is the permeation flux, Δp (pa) the Trans membrane pressure (TMP), μ (kg/m.sec) the absolute viscosity of the water, and R_m (m^{-1}) the hydraulic resistance of the clean membrane (or clean membrane resistance).

For suspension filtration, the permeation flux will always be lower than that given by Equation (1). Flux decline is a result of the increase of membrane resistance to the permeating flow, resulting from membrane fouling or particle deposition on or in the membrane. The mechanisms of membrane fouling usually include pore blocking, concentration polarization and cake formation. For microfiltration, the fouling by

concentration polarization may be negligible due to the large size of the particles retained (Leow and Bai, 2002).

Thus, the permeation flux through a microfiltration unit treating oily wastewater, can be given, by modifying Equation (1), as: (Leow and Bai, 2002)

$$J = \frac{\Delta p}{\mu(R_p + R_m + R_c)} \quad \dots(2)$$

Where R_p (m^{-1}) is the resistance due to pore blocking, and R_c (m^{-1}) the resistance arising from cake formation.

For microfiltration at a constant TMP, the initial permeate flux J_0 ; will mainly depend on R_m as R_p and R_c are initially zero. With the proceeding of microfiltration operation, pore blocking and cake formation will cause R_p and R_c to increase, and change the relative significance of R_m , R_p , and R_c in Equation (2), and the microfiltration process can transfer from a membrane resistance to a pore blocking resistance or a cake resistance process. Based on this, generally four fouling mechanisms for porous membranes can be observed, these are (Subramanian and Raghavarao, 2001):

a. Complete blocking model

Complete blocking model assumes that particles arrive at the membrane and seal the membrane pores such that the particles are not superimposed upon the other. The blocked surface area is proportional to the permeate volume.

b. Standard blocking model

In standard blocking model, the particle diameter is much less than the pore diameter, thus, the particles can enter most pores, deposit on the pore walls, and thus reduce the pore volume. The decrease of pore volume is also proportional to the permeate volume.

c. Intermediate blocking model

In intermediate blocking model, the number of blocked pores or surface is also assumed to be proportional to the permeate volume but it is less restrictive in such a way that not every particle necessarily blocks the pores and particles may settle on other particles.

d. The cake filtration model

The cake filtration model is used to explain for the case of large particles, which cannot enter most pores, and hence, deposit forms a cake on the membrane surface.

For microfiltration at a constant transmembrane pressure, the permeation fluxes under each of these case may be given as:

a. Complete pore blocking model:

$$J = J_0 \exp(-k_b t) \quad \dots(3)$$

b. Standard pore blocking model:

$$J = J_0 \left(1 + \frac{1}{2} K_s (AJ_0)^{0.5} t \right)^{-2} \quad \dots(4)$$

c. Intermediate pore blocking model:

$$J = J_0 (1 + K_i AJ_0 t)^{-1} \quad \dots(5)$$

d. Cake filtration model:

$$J = J_0 (1 + 2K_c (AJ_0)^2 t)^{-0.5} \quad \dots(6)$$

Where J_0 depends on the transmembrane pressure, membrane resistance and viscosity of the filtrate and is expressed as $J_0 = \Delta P / \mu R_m$. The various K terms represent mass transfer coefficients for the associated filtration laws (Nandi et al., 2010).

In the case of constant pressure filtration, the term (AJ_0) is constant and the filtration laws can be simplified to:

a. Complete pore blocking model:

$$\ln(J) = \ln(J_0) - k_b t \quad \dots(7)$$

b. Standard pore blocking model:

$$(1/J^{0.5}) = (1/J_0^{0.5}) + k_s t \quad \dots(8)$$

c. Intermediate pore blocking model:

$$(1/J) = (1/J_0) + k_i t \quad \dots(9)$$

d. Cake filtration model:

$$(1/J^2) = (1/J_0^2) + k_c t \quad \dots(10)$$

Where $k_s = (1/2) K_s A^{0.5}$, $k_i = K_i A$, $k_c = 2K_c A^2$.

Consequently plotting the left-hand side flux functions for each model against time are the tests to determine the more appropriate model and the means to obtain the mass transport parameters from the slope. Therefore, a plot of $\ln(J)$ vs. t , $(1/J^{0.5})$ vs. t , $(1/J)$ vs. t and $(1/J^2)$ vs. t shall be a straight line with slope of k_b , k_s , k_i and k_c , with y-intercept of $\ln(J_0)$, $(1/J_0^{0.5})$, $(1/J_0)$ and $(1/J_0^2)$ for complete pore blocking, standard pore blocking, intermediate pore blocking and cake filtration model, respectively. This is shown in figures 13 to 17. The appropriate fitness and competence of various fouling models can be confirmed by comparing the values of coefficient of correlation (R^2) obtained from the linear regression analysis (Peng and Tremblay, 2008).

Oil Removal Efficiency

Produced water treating equipment performance is commonly described in terms of its “oil removal efficiency.” This efficiency considers only the removal of dispersed oil and neglects the dissolved oil content. For example, if the equipment removes half of the dispersed oil contained in the influent produced water, it is said to have 50% oil removal efficiency. For a specific piece of equipment or an overall

system, the oil removal efficiency can be calculated using the following equation:

$$R\% = \left(1 - \frac{C_P}{C_F}\right) * 100 \quad \dots(11)$$

Where

R % = oil removal efficiency, (rejection percentage)

C_P = dispersed oil concentration in the water outlet (effluent) stream, ppm.

C_F = dispersed oil concentration in the water inlet (influent) stream, ppm.

Experimental Materials

These filters have columnar filter element sealed within a pressure vessel to produce dry / wet cake. Figure 1 show picture of Candle Filter.

a) Ceramic filter: metal filter such as zirconium or titanium oxide over the support structure of an aluminum oxide tube.

The specifications of the filter are as follow:

- Absolute filtration to 0.5 micron
- Removes algae ,rust ,sediment ,suspended solids
- Flow rate (liters) to 8 LPM
- Pressure to 3 bar
- Turbidity reduction

b) Polypropylene filter: Manufactured from pure 100% polypropylene.

The specifications of the filter are as follow :(Made in China)

- Designed for purity and chemical compatibility.
- Spun fibers from a true gradient density from outer to inner surfaces.
- Temperature Range: 4.4 °C to 62.8 °C
- Dimensions: L = 25 cm and d = 6.5 cm
- Effective area: 0.051 m²
- Absolute filtration to 1 micron

Experimental Procedure and Equipments

Oil – Water emulsions were prepared by vigorous mixing of oil and water in the QVF glass vessel (30 l), using a stirrer (Janke and Kunkelkg, England, 1 KA – Werk, RW 50 H, Staufen) at an agitation speed of 0 - 10000 rpm, Classic Oil 20W-50 and Edible Vegetable Oil was used for the preparation of the oil-water emulsions with oil concentration of 50, 400 and 800 ppm. The physical and chemical properties of the oil are given in Table 1.

Feed solution was prepared in the QVF glass vessels by mixing with the oil (20W - 50) in 30 liter of tap water, since stirring a mixture of small amount of oil in water made an emulsion which was stable during the experiment, no emulsifier was used. The out let valve of the feed vessel was open to let the emulsion fill the whole pipes of the system. The emulsion feed drawn from the feed vessel by means of a centrifugal pump to pass through filter (Polypropylene or Ceramic) to remove oil from oil – water emulsions. Permeate (filtered water) was collected every 30 minutes and volume of permeate during the interval was measured and recorded. The oil concentrations in the feed and permeate solutions were analyzed using UV spectrophotometer. The filtration flux was calculated by dividing the permeate volume by the product of effective membrane area and time.

An experimental rig was constructed in the laboratory as shown schematically in Figure 2 and pictured in Figure 3. Experimental system consists of:

1) Microfiltration Membrane: Two types of filters candle-polypropylene (1 micron) and candle-ceramic (0.5 micron) are used to remove oil from wastewater.

- 2) **Feed vessel:** The QVF glass vessels with a capacity of 30 liters were used as feed vessel.
- 3) **Rotameters:** Calibrated Rotameters is used to measure the volumetric flow rate of feed (O/W emulsions) inlet to membrane separation unit (range of 10 – 60 l/h).
- 4) **Pressure gauge:** One pressure gauge is used in the feed (O/W emulsions) line to indicate the feed pressure (range of 0 – 2.5 bar).
- 5) **Heater:** In order to maintain the temperature at a certain value, one submersible electrical coil (220 Volt, 1000 Watt) and thermostat of range from 0 to 80 °C was used as a heating media.
- 6) **pH Meter:** The pH value measurement was carried out by means of a bench pH meter with specification as following: (Type = SensoDirect pH200 , Range = 0 – 14 pH, Accuracy = \pm 0.01 pH, Power requirements = AC/DC 6V)
- 7) **Digital Balance:** A digital balance with 4 decimal points (Sartorius BP3015 max. 303 g, d = 0.1 mg) is used to measure the samples weight in experiments.
- 8) **Pump:** Centrifugal pump was used to pump the feed (O/W emulsions) from vessel to membrane cell (54.5 – 11.4 l/min, 3 – 13.7 m. H, 210 Watt, Stuart Turner LTD. Henley on Thames Eng. (England)).
- 9) **Spectrophotometer:** The concentration of oil in water was measured using spectrophotometer, with specification as following: (Model = Genesys 10 UV, Wave length = 1090 – 190 nm ,Power = 50 / 60 HZ Made in U.S.A)

Results and Discussion

In oily waste water treatment processes, oil concentration in

emulsion often changes because of different input situations.

Effect of Oil Concentration

In this process, higher concentration from the feed oil is produced the lower permeate flux. This is shown in Figure 4. The feed oil concentration has a direct influence on adsorption of oil (fouling). Fouling is mainly due to adsorption of oil on the membrane structure, which modifies the critical surface tension and the wettability, as well as the effective pore diameter, resulting in reduced membrane permeability (Sama, 2011; Rajagopalan, 1998). The high oil concentration in feed increases the oil adsorption and causes easily great resistance for permeating water. Therefore, Figure 5 illustrates the permeate (or product) concentration of oil increased with the increase in feed concentration. The increase of oil concentration will decrease the rejection percentage and vice versa (according to Equation 11). As the feed concentration of oil increases, the reject concentration (or concentrate) will increase. This is shown in Figure 6. Also, we can by increasing the operation time, the flux, oil rejection, and reject concentration will decreases. A similar observation was noticed in the experimental study of (Lawrence and Jiaping, 2011). The pressure and pH value for all experiments are 0.125 bar and 8.2 respectively.

Effect of Operating Temperature

In Figure 7, the permeate flux increased with an increase in the temperature. The higher temperature may lead to an enhancement of the activity of water molecules and a decline of the emulsion viscosity. Therefore, the rejection percentage of oil decreased with increase in operating temperature i.e. the oil concentration in product increased.

This is shown in Figure 8. The effect of temperature on the flux and permeate concentration explains the effect of temperature on reject concentration. Thus, the reject concentration increases with increasing temperature (see Figure 9). These results correspond with the results of the researcher (Sama, 2011; Lawrence, 2011).

Effect of Flow Rate

Flow rate is an important operation parameter for MF. High flow rate is used to reduce cake formation and/or concentration polarization. The convection to and diffusion away from the membrane surface determine the rate of build-up of fouling, the rate of convection to the membrane is a function of the permeate flux, and the diffusion away is linked to the degree of turbulence (Cheryan and Rajagopalan, 1998). According to this information we observe, the flux increased with an increase in feed flow rate. An increase in the cross-flow velocity will directly increase in oil rejection % and increase in the reject concentration. This is shown in Figures 10 to 12. These results correspond with the results of the researcher (Samah, 2013).

The Filtration Models

Figures 13 to 17 show application of Hermia's model (filtration models) for prediction and experimental data in dead end process. In most cases the models exhibit a reasonable agreement with experimental data giving linear correlations. The model correlations for each case are given in Figures 13 to 17. The estimation of the flux at $t = 0$ (J_0), from the intercept, gives the following values, 187.73, 189.94, 192.68 and 200.32 $l/m^2.h$ for the complete pore blocking, standard pore blocking, intermediate pore blocking and cake filtration models,

respectively. These values are different from the initial experimental flux, measure at 196.07 $l/m^2.h$. The best agreement with experimental data is given by the complete pore blocking model and came in second level, the standard model for polypropylene membrane (1 μm). These results correspond with the results of the researcher (Hasan, 2011; Erik, 1989).

Conclusions

The following conclusions could be drawn from this study:

1. Microfiltration can be used for the treatment of oily wastewater.
2. The flux decreases with increasing operating time and feed oil concentration. While, the flux of the membrane increases with increasing operating temperature, feed flow rate and pore size of membrane for dead end and cross flow.
3. The oil rejection percent increases with increasing flow rate. While, the rejection percentage decreases with increasing time, feed oil concentration, feed temperature and pore size of membrane for dead end and cross flow.
4. The reject concentration (or the concentrate) increases with increasing flow rate, feed concentration, time and feed temperature.
5. In the dead end process the amount of flux is more than cross flow process. While, in the cross flow the oil rejection percentage is best than dead end.
6. The amount of flux for Vegetable Oil more than oil 20W-50, but rejection percentage for Vegetable Oil is less than rejection percentage for oil 20W-50.
7. The highest recovery ratio is 44.8% using cross flow process with recirculation of concentrate stream.
8. In the microfiltration process, the highest rejection percentage of oil is

98% and 97.8% for cross flow and dead end respectively.

Experimental results in this work were in excellent agreement with complete

pore blocking model and the standard model.

Nomenclature

Symbol	Description	Units
ΔP	Transmembrane Pressure	pa
μ	Viscosity	kg/m.sec
A	Area	m^2
C_F	Feed Concentration	mg/l
C_P	Permeate Concentration	mg/l
F	Centrifugal Force	kg .m/s ²
J	Permeation Flux	$m^3/m^2.sec$
J_0	Initial Permeate Flux	$m^3/m^2.sec$
k_b	Mass Transfer Coefficient for Complete pore blocking model	m/sec
k_c	Mass Transfer Coefficient for Cake filtration model	m/sec
k_i	Mass Transfer Coefficient for Intermediate pore blocking model	m/sec
k_s	Mass Transfer Coefficient for Standard pore blocking model	m/sec
m	Mass of Particle	kg
Q_{feed}	Feed Flow Rate	l/hr
$Q_{permeate}$	Permeate (or Product) Flow Rate	l/hr
r	Distance from Central axis Rotation	m
$R \%$	Rejection Percentage	
R^2	Correlation of Coefficient	
R_c	Cake Resistance	m^{-1}
R_m	Clean Membrane Resistance	m^{-1}
R_p	Pore Blocking Resistance	m^{-1}
t	Time	h
T	Temperature	°C
ω	Angular Velocity	rad/s

Abbreviation

Symbol	Description
MF	Microfiltration
O/W	Oil-in-Water
W/O	Water-in-Oil

References

- 1- Beccari M., Majone M., Riccardi C., Savarese F. and Torrisi L. (1999). "Integrated treatment of olive oil mill effluents: effect of chemical and physical pretreatment on anaerobic treatment", Water Sci. Tech., 40(1), 347-355.
- 2- Cheryan M. (1998) "Ultrafiltration and Microfiltration Handbook", pp.

- 71-112. Lancaster, United States: Technomic Publishing Company.
- 3- Cheryan M. and Rajagopalan N. (1998): "Membrane Processing of Oily Streams", Wastewater treatment and waste reduction, *J. Membr. Sci.*, 151(1), 13-28.
 - 4- H.F. Leow and R.B. Bai (2002) "Modeling and experimental study of microfiltration using a composite module", *J. Membr. Sci.* 204 359.
 - 5- Hasan Ferhood Makki, Ahmed Faiq Al-Alawy, Maha H. Al-Hassani and Zaid Waadulla Rashad (April 2011) "Membranes Separation Process for Oily Wastewater Treatment" , *Journal of Engineering*, Number2 Volume 17.p 15
 - 6- Jassim M.K., (2008), "Using of Local Bentonite for Removal of Oil Contaminants from Industrial Wastewater", M.Sc. Thesis, University of Baghdad.
 - 7- Lawrence K. Wang and Jiaping P. Chen (2011), " Membrane and Desalination Technologies" *Handbook of Environmental Engineering*, vol. 13,p 178
 - 8- Mike P. and Ivan A.C., (2008), "Ultrafiltration for Oily Industrial Water", NC AWWA-WEA conference November 17.
 - 9- Nandi B.K., Moparathi A., Uppaluri R. and Purkait M.K. (2010), "Treatment of oily wastewater using low cost ceramic membrane: Comparative assessment of pore blocking and artificial neural network models", *chemical engineering research and design*.
 - 10- Peng H. and Tremblay A.Y. (2008), "Membrane regeneration and filtration modeling in treating oily wastewaters", *Journal of Membrane Science* (324), 59 – 66.
 - 11- Peter A. Williams (2007) "Handbook of Industrial Water Soluble Polymers" by Blackwell Publishing Ltd.
 - 12- Sama Mohammed Abdullah (April 2011) "Oily Water Treatment using Ceramic Membrane" , *Journal of Engineering*, Number2 Volume 17,p25
 - 13- Samah Mohsin Al – Musawi, (2013), "Separation of Oil from Oil in Water Emulsions Using Microfiltration Membranes", M.Sc. Thesis, University of Baghdad.
 - 14- Schramm L. L. (1992), "Petroleum emulsions-basic principles", in *Emulsions: Fundamentals and Applications in the Petroleum Industry*, American Chemical Society, Washington, D.C., pp. 1–49.
 - 15- Shams Ashaghi, K., Ebrahimi, M. and Czermak, P., (2007), "Ceramic Ultra- and Nanofiltration Membranes for Oilfield Produced Water Treatment: A Mini Review", *the Open Environmental Journal*, (1), 1-8.
 - 16- Shaw D. J. (1991) "Introduction to Colloid and Surface Chemistry" Fourth edition, Butterworth - Heinemann Ltd, Great Britain.
 - 17- Syed R.Q., Edward M.M. and Guang Z., (2000), "Water Works Engineering: Planning, Design, and Operation", Prentice – Hall, Inc., USA.
 - 18- Thomas E. Schultz (2007), "Wastewater treatment for the petroleum industry", *Technology and Trends Specialist Article*, *Panda Select Oil and Gas*.
 - 19- Xianguo HU and Gyula Vatai (2005), "Ultrafiltration of Oily Emulsion for Metal Cutting Fluid: Role of Feed Temperature" , *Environment Protection Engineering* , Vol. 31,No. 3-4.

Table 1, the Physical and Chemical Properties of Oil

Classic Oil 20W-50	
Viscosity grade	20W-50
Colour	Amber
Physical State	Liquid at ambient temperature
Odour	Characteristic mineral oil
Vapour Pressure	Expected to be less than 0.5 Pa at 20 °C
Initial Boiling Point	Expected to be above 280 °C
Solubility in Water	Negligible
Density	888 kg/m ³ at 15 °C.
Flash Point	215 °C
Flammable Limits - Upper	1% (V/V)
Flammable Limits - Lower	10% (V/V)
Auto-Ignition Temperature	Expected to be above 320°C
Kinematic Viscosity	157 mm ² /s at 40 °C
Pour Point	-27 °C
Vegetable Oil	
Density	985 kg/m ³
Viscosity	4.01×10 ⁻² kg/m.sec
Type	ZER (Made in Turkey)



Fig. 1, Candle Filter

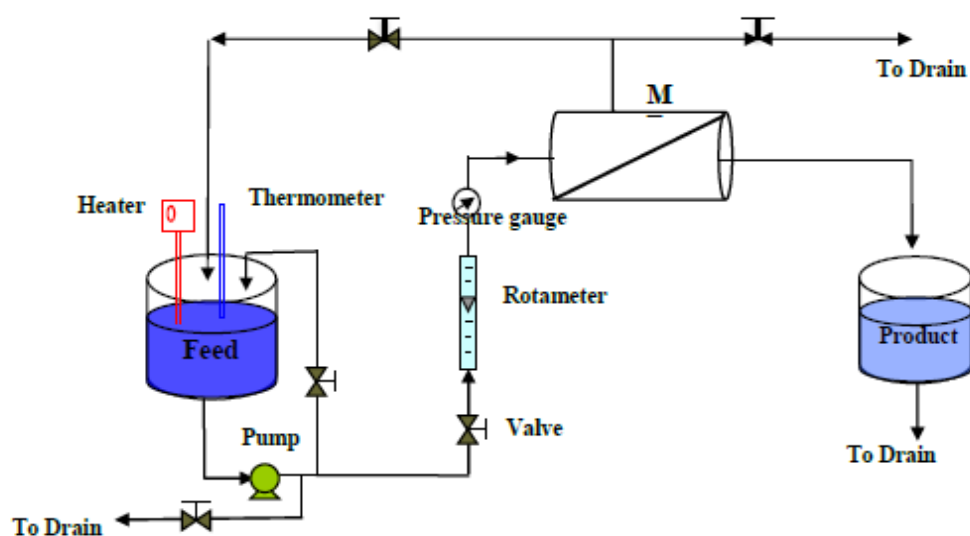

Fig. 2, Schematic Diagram of Microfiltration Process

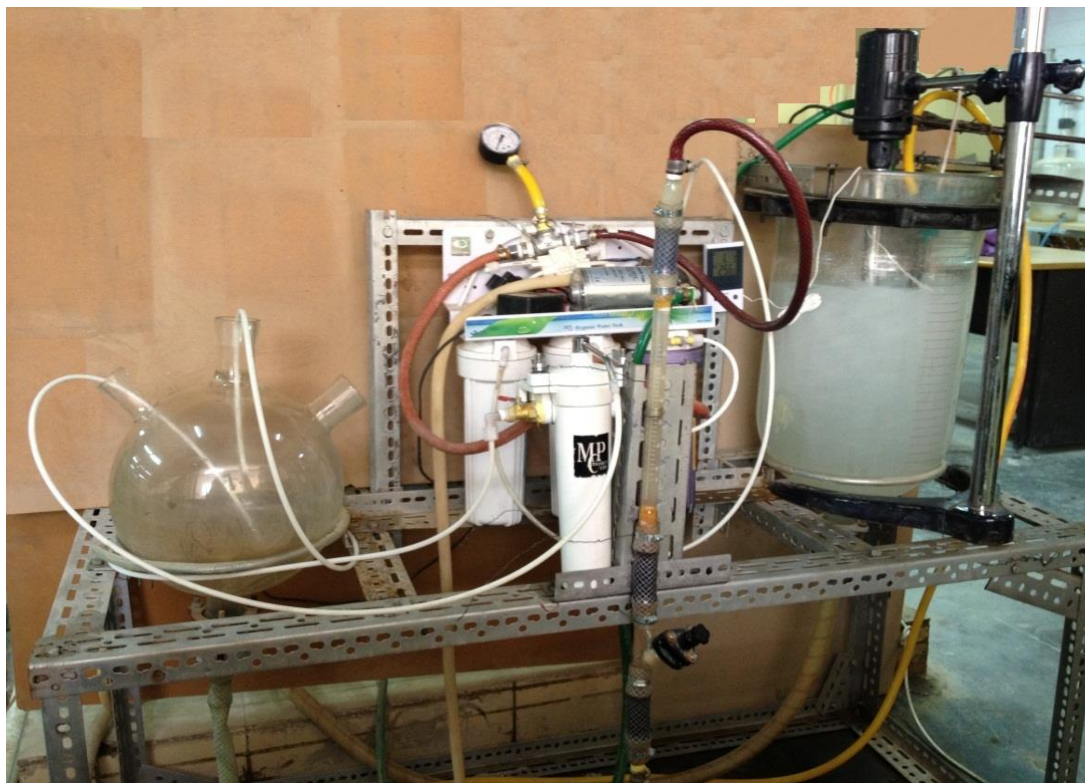

Fig. 3, Picture Experimental System Consists

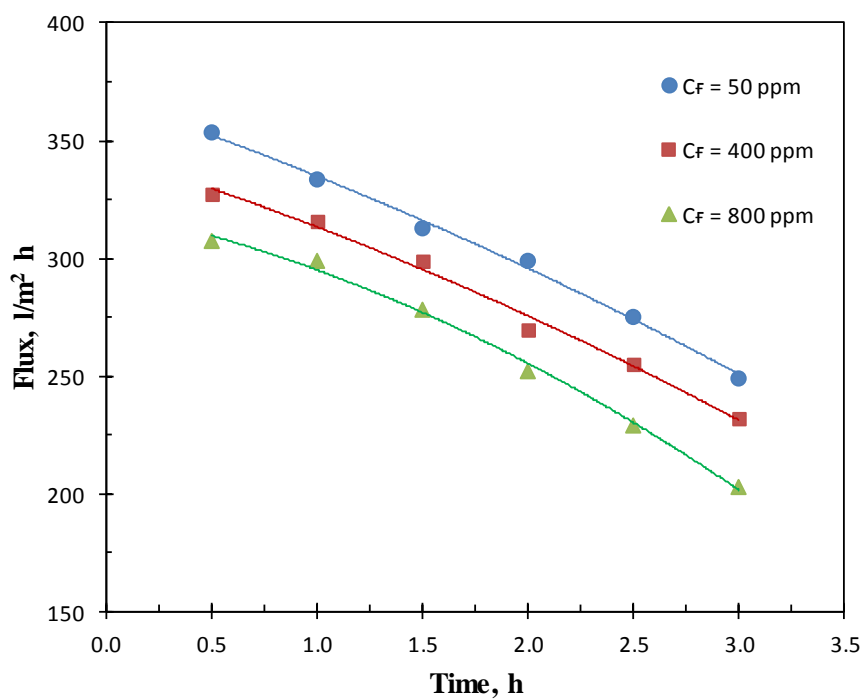

Fig. 4, Flux vs. Time at Different Oil Concentrations (Ceramic 0.5 μm , $Q_F = 25 \text{ l/h}$, Oil 20W-50 and $T = 40^\circ\text{C}$)

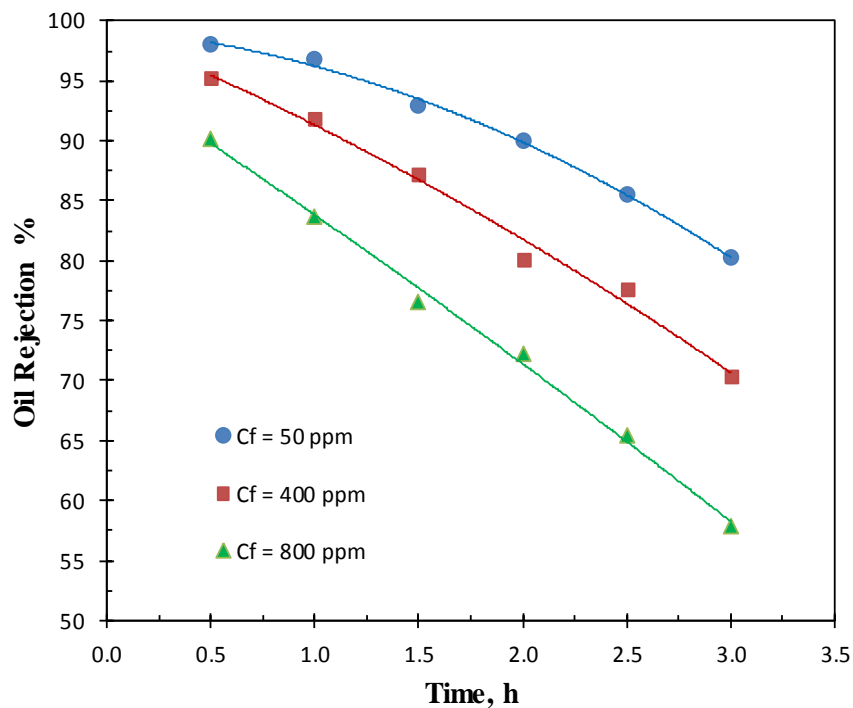

Fig. 5, Oil Rejection % vs. Time at Different Oil Concentrations (Ceramic 0.5 μ m, $Q_F = 25$ l/h, Oil 20W-50 and $T = 40^\circ\text{C}$)

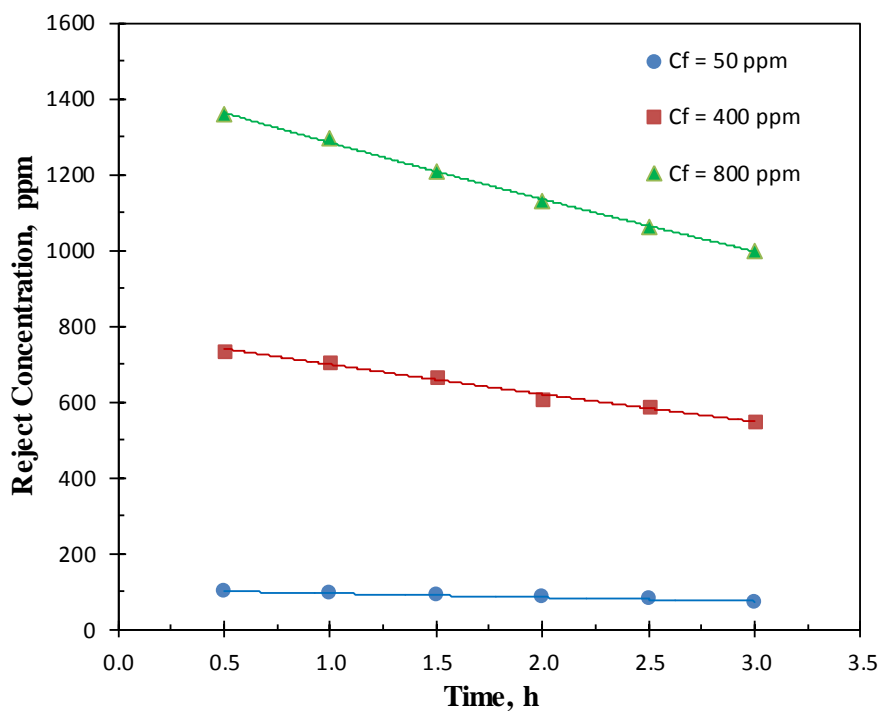

Fig. 6, Reject Concentration vs. Time at Different Oil Concentration (Ceramic 0.5 μ m, $Q_F = 25$ l/h, Oil 20W-50 and $T = 40^\circ\text{C}$)

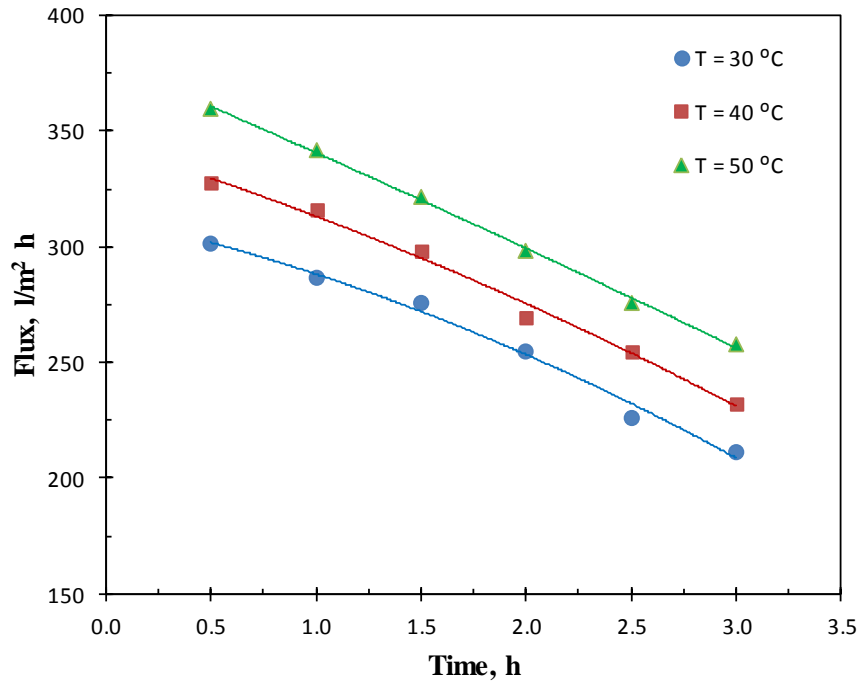

Fig. 7, Flux vs. Time at Different Feed Temperature (Ceramic 0.5 μm , $Q_F = 25$ l/h, Oil 20W-50 and $C_F = 400$ ppm)

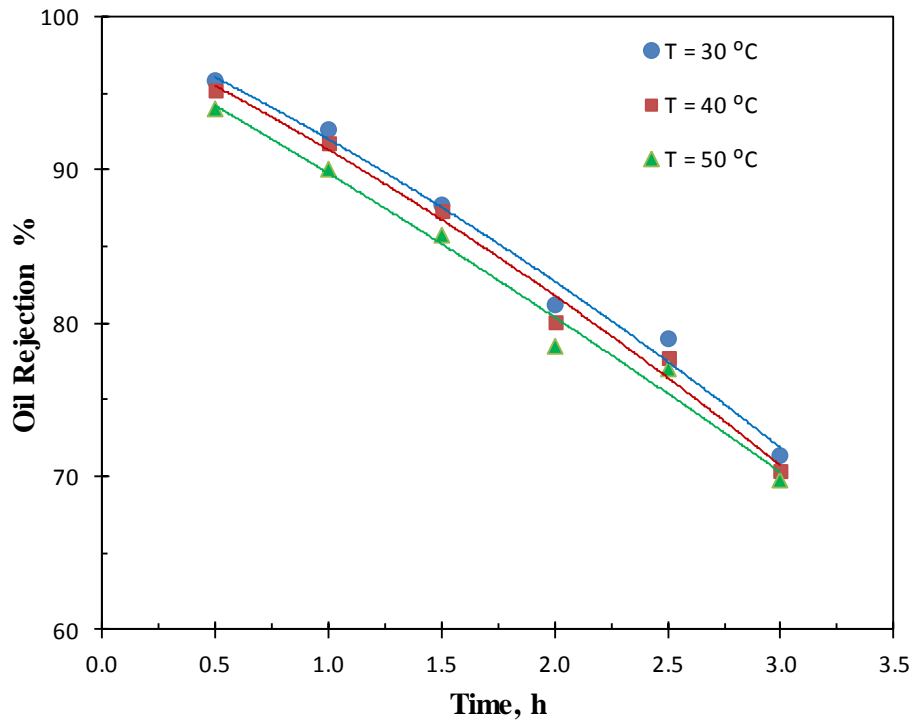

Fig. 8, Oil Rejection % vs. Time at Different Feed Temperature (Ceramic 0.5 μm , $Q_F = 25$ l/h, Oil 20W-50 and $C_F = 400$ ppm)

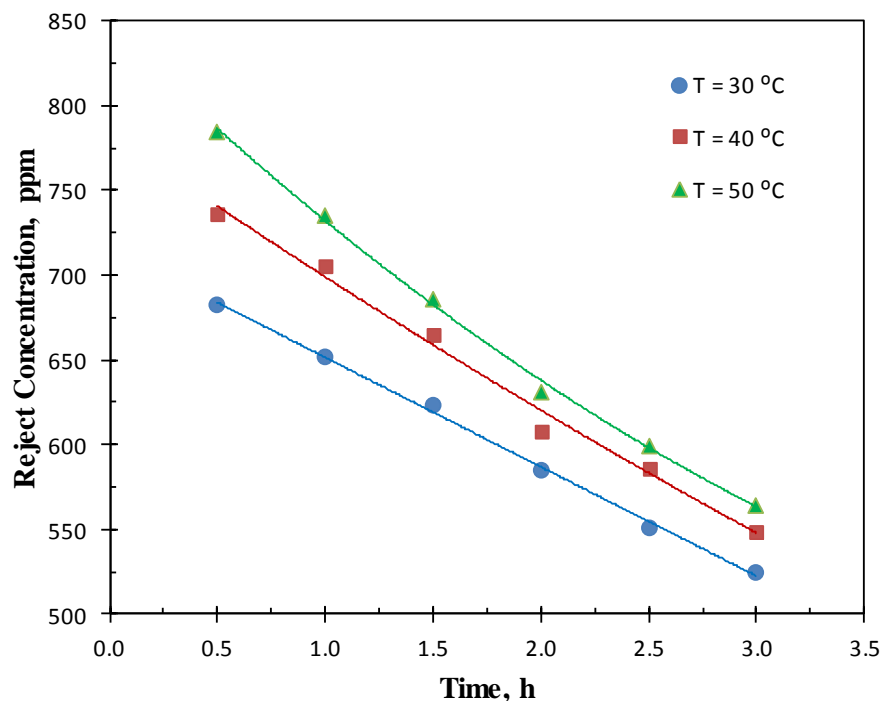

Fig. 9, Reject Concentrations vs. Time at Different Feed Temp. (Ceramic 0.5 μ m, $Q_F = 25$ l/h, Oil 20W-50 and $C_F = 400$ ppm)

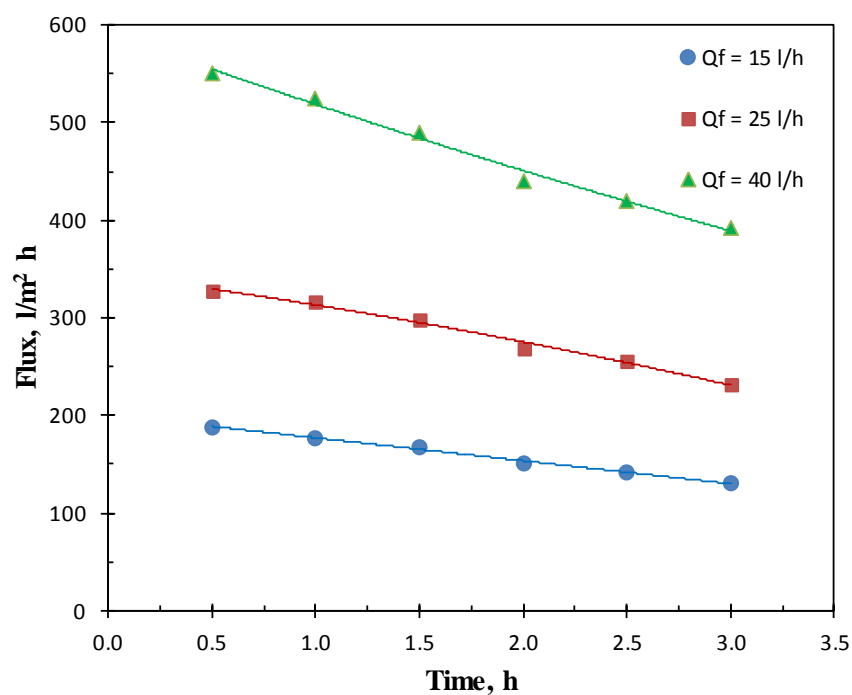

Fig. 10, Flux vs. Time at Different Feed Flow Rate (Ceramic 0.5 μ m, $T = 40^\circ\text{C}$, Oil 20W-50 and $C_F = 400$ ppm)

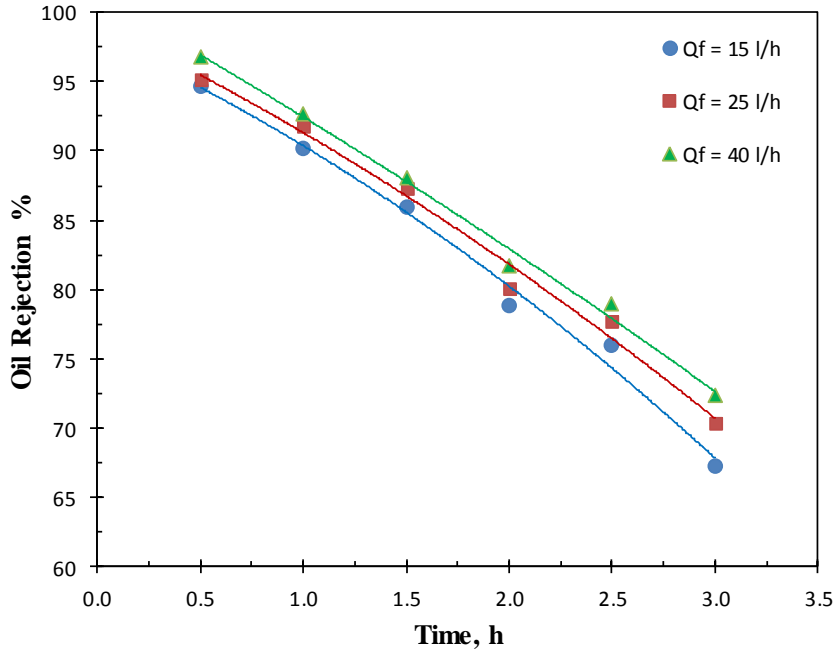

Fig. 11, Oil Rejection % vs. Time at Different Feed Flow Rate (Ceramic 0.5 μ m, T = 40°C, Oil 20W-50 and C_F = 400 ppm)

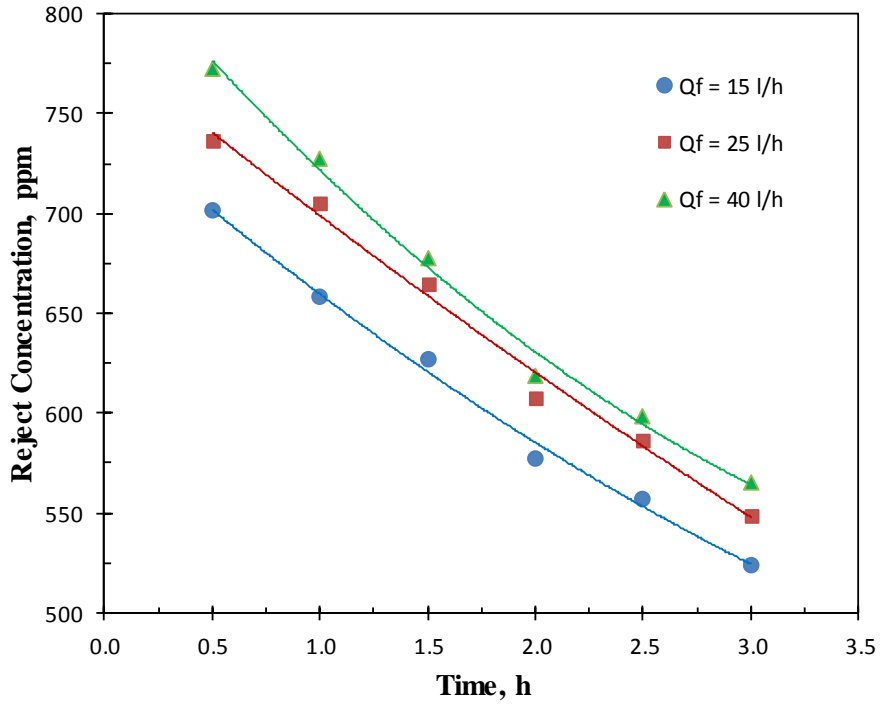

Fig. 12, Reject Concentration vs. Time at Different Feed Flow Rate (Ceramic 0.5 μ m, C_F = 400 ppm, Oil 20W-50 and T = 40°C)

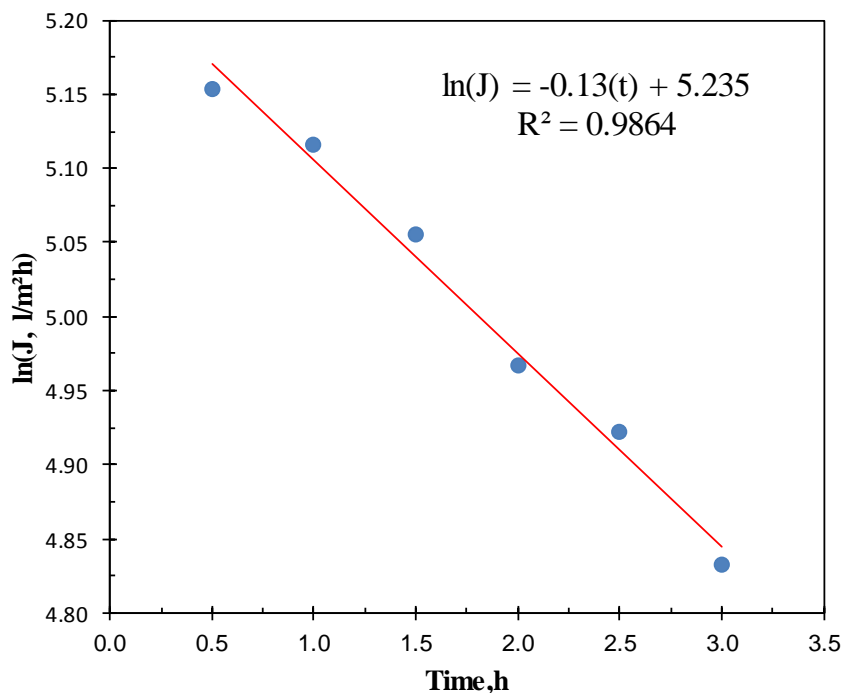

Fig. 13, Complete Pore Blocking Model ($C_F = 400$ ppm, $T = 30^\circ\text{C}$ and $Q_F = 10$ l/h)

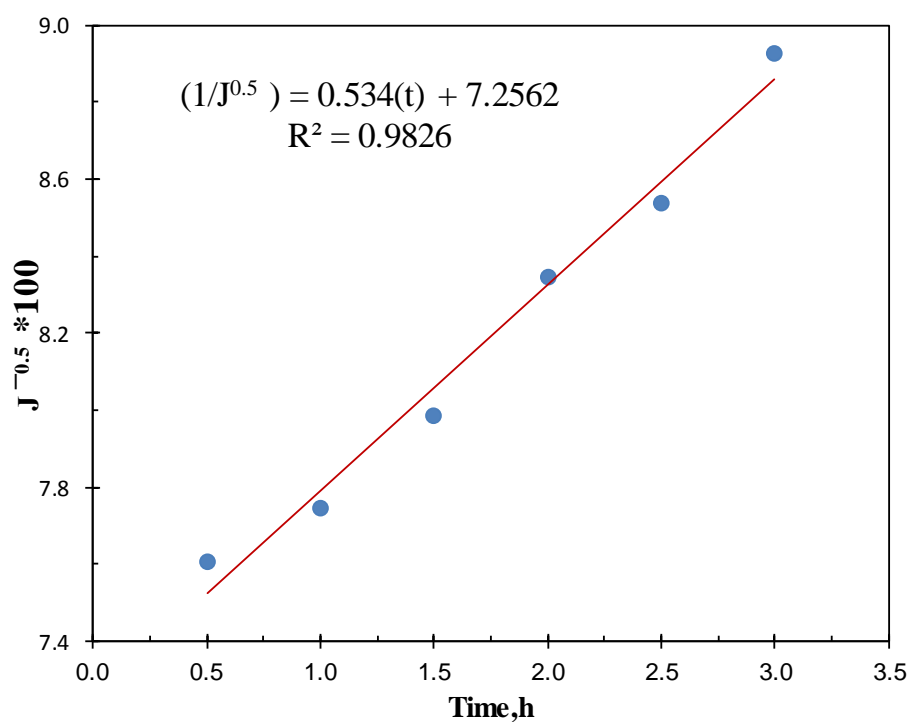

Fig. 14, Standard Pore Blocking Model ($C_F = 400$ ppm, $T = 30^\circ\text{C}$ and $Q_F = 10$ l/h)

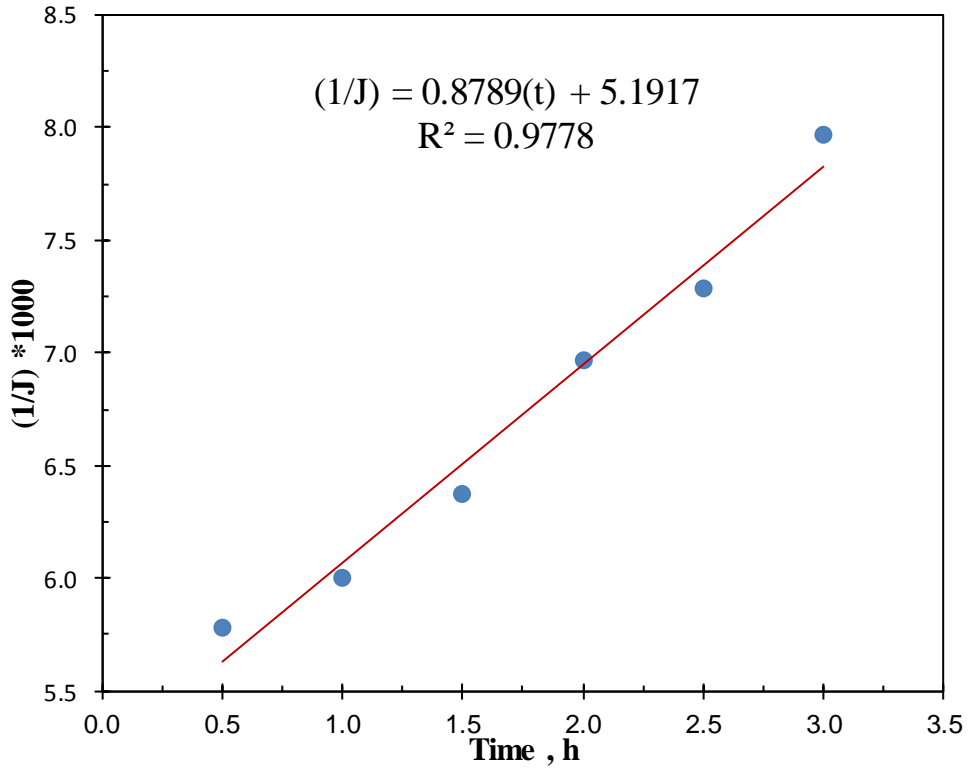

Fig. 15, Intermediate Pore Blocking Model ($C_F = 400$ ppm, $T = 30^\circ\text{C}$ and $Q_F = 10$ l/h)

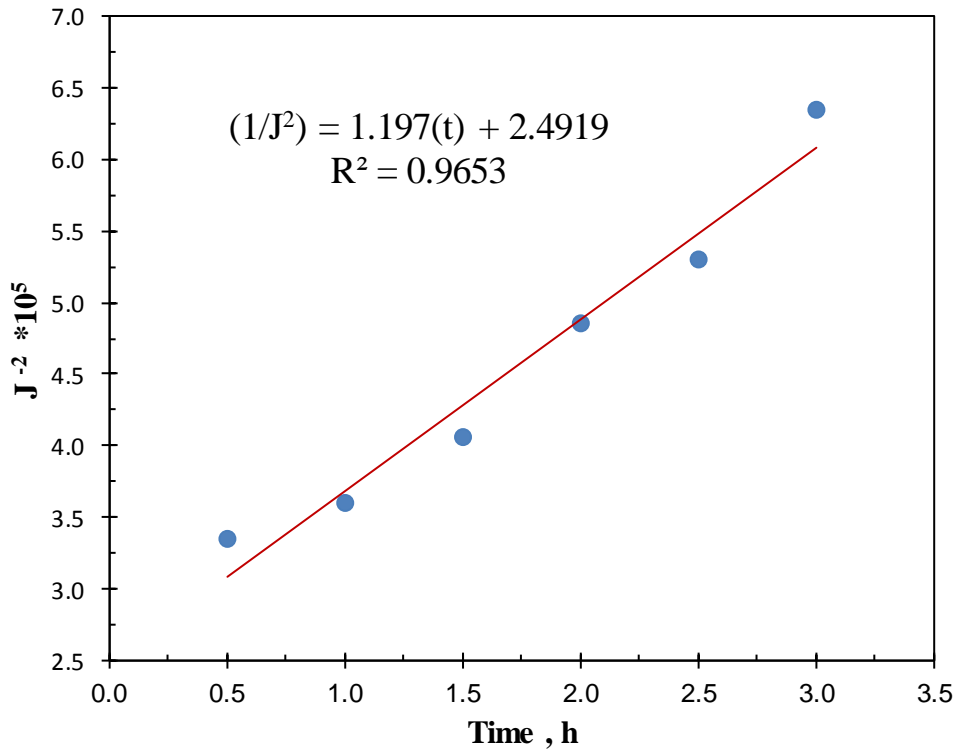

Fig. 16, Cake Filtration Model ($C_F = 400$ ppm, $T = 30^\circ\text{C}$ and $Q_F = 10$ l/h)

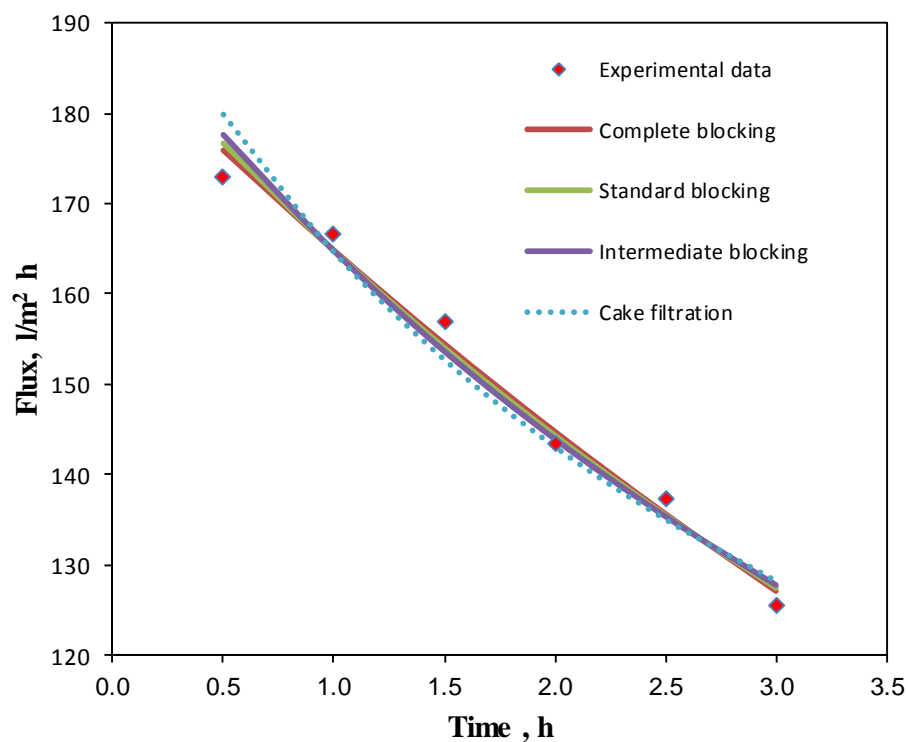

Fig. 17, Comparison of Filtration Model Prediction with Experimental Data for Polypropylene Membrane (1 μ m)