

## Comparison between Using FLC and Auto-Tuning FLC in Synchronous Generator Transient Voltage Stability Enhancement

**Dr. Majli Nema Hawas**

College of Electrical and Electronic Techniques; Baghdad

Email: [nmajli@yahoo.com](mailto:nmajli@yahoo.com)

**Abdullah Yaseen Abbas**

College of Electrical and Electronic Techniques; Baghdad

Received on: 16/4/2012 & Accepted on: 6/12/2012

### ABSTRACT

This paper compares between responses of Fuzzy Logic Controller (FLC) based exciter and auto-tuning FLC based exciter. Both of the exciters are simulated separately with synchronous generator connected to infinite bus through a short transmission line. The systems were subjected to three phase fault at the infinite bus, maximum Integral of Square Error (ISE) of generator terminal voltage response and critical clearing time were taken as performance indices of the exciters. The systems then studied under normal operating condition to justify the need of auto-tuning.

**Keywords:** Power System Simulation; Generators; Voltage Control; Fuzzy Control; Adaptive Control.

مقارنة بين استخدام متحكم المنطق الضبابي وبين متحكم المنطق الضبابي تلقائي  
التنغيم لتحسين استقرارية الجهد العابر لمولد متزامن

### الخلاصة

هذه الورقة تقارن بين استجابة محفز معتمد على مسيطر ضبابي واستجابة محفز معتمد على مسيطر ضبابي ذاتي التنغيم. تم محاكاة كل محفز على حده للسيطرة على الجهد الطرفي العابر للمولد تزامني متصل بعمومي لانتهائي خلال خط نقل قصير. أخضع النظام الى اضطراب ثلاثي الطور على العمومي اللانتهائي. استخدم تكامل مربع الخطأ لاستجابة الفولتية الطرفية للمولد وزمن الإزالة الحرج كدلائل لمعرفة الإداء للمحفزات في ظروف العمل المضطربة وتم إثبات الحاجة الى التنغيم الذاتي في ظروف العمل الطبيعية.

### INTRODUCTION

Like the power angle, voltage exhibits an oscillatory behavior when displaced from equilibrium. Usually, a departure from equilibrium (a voltage spike) is expected to dampen out very quickly, though sometimes continuing oscillations are observed, especially in the event of major disturbances <sup>[1]</sup>.

In any electrical power network synchronous generators are the primary source of reactive power and are to a great extent responsible for maintaining a good voltage profile across the electric power system. Consequently their characteristics and their limitations are of major importance for the analysis of voltage stability. It is worth noting that in almost all voltage instability incidents, one or several crucial generators were operating with limited reactive capability. The main functions of generator excitation system are to maintain generator voltage and control the reactive power flow<sup>[2]</sup>.

Significant improvements in transient stability can be achieved through rapid temporary increase of generator excitation. The increase of generator field voltage during transient disturbance has the effect of increasing the internal voltage of the machine; this in turn increases the synchronizing power<sup>[3]</sup>.

The voltage regulator and exciter characteristics can affect stability because; if all things being equal, higher field excitation requires a smaller rotor angle. Consequently, stability is enhanced by a properly applied regulator and exciter that respond rapidly to transient effects and furnish a high degree of field forcing. In this respect, modern solid-state voltage regulators and static exciters can contribute markedly to improved stability<sup>[4]</sup>.

## **FLC AND ITS NEED IN POWER SYSTEM CONTROL APPLICATIONS**

Due to the facts that modern electric power systems are being operated close to their limits and they are highly non-linear complex systems, the application of Artificial Intelligence based controllers in electric power systems is becoming an important field of research. The FLC uses linguistic, not numerical, variables, making it similar to the way humans think; it also relates output to input, without having to understand all the variables, permitting the design of a system that may be more accurate and stable than one with a conventional control system<sup>[5 & 6]</sup>.

The basic configuration of the FLC can be simply represented in four parts, as shown in Figure (1).

Fuzzifier module, its function is to transform the input numerical values to the corresponding linguistic (fuzzy) variables with appropriate membership values.

Knowledge base, which includes the definitions of the fuzzy membership functions defined for each control variable and the necessary rules that specify the control goals using linguistic variables.

Inference mechanism, it is capable of simulating human decision making and influencing the control actions based on fuzzy logic.

Defuzzifier module, which converts the inferred decision from the linguistic variables back to numerical values.

## **SIMULATED SYSTEM**

The system under study is shown in Fig. 2, which consists of one synchronous generator connected to an infinite bus by a short transmission line with  $r_e$  and  $x_e$ .

Figure (3) shows a block diagram for the terminal voltage control sequence of the synchronous generator.

## FLC BASED EXCITERS DESIGN AND SIMULATION

In order to enhance the voltage response of the system and in order to keep the system stable, FLC based exciters must be designed to fulfill the following requirements<sup>[8]</sup>:

- i. Minimize maximum ISE of the generator terminal voltage.
- ii. Minimize average of absolute error voltage ( $|V_{err}|$ ) of the generator terminal voltage.
- iii. To have stabilizing effect in order to keep the generator in synchronism with the rest of the network.
- iv. Fast controlling action which will make the generator able to withstand a relatively longer fault durations.

The system in Figure (2) will be simulated by solving its equations (the synchronous generator model was taken from<sup>[9]</sup>) MATLAB/Simulink, the disturbance subjected to the three phase solid fault on the infinite bus twice which will reduce the infinite bus voltage each time to zero. Previous simulation with standard DC1A exciter was carried out in<sup>[10]</sup> and compared with a designed non-auto-tuning FLC based exciter, this paper will simulate the system with FLC based exciters only. Nearly 14 FLC based exciters were designed of both Mamdani and Takagi-Sugeno types with different membership functions and defuzzification methods. All of them used the same rule base shown in table 1 and applied to the synchronous generator as shown in Figure (4).

The one with Takagi-Sugeno type, Gaussian membership function and weighted sum defuzzification method had the best response indices (0.41 sec. critical clearing time, 0.5464 max ISE). Figure (5) shows these responses.

The control surface of designed FLC based exciter with best response is shown in Figure (6).

This best designed FLC based exciter is very good under fault conditions but as shown in Table (2) it suffers from steady state error during normal working conditions, due to this reason and in order to extend this controller to all working conditions it would need an auto-tuning auxiliary controller.

The need of an auxiliary FLC to auto-tune the gains of the main FLC comes from the different working conditions. For example if the gain of the control signal (excitation voltage) increases as the absolute error voltage increases it would accelerate the controlling action of the exciter.

The auto-tuning controller can be designed to control the gains of both the control signal and the input signals, so it will enable the controller to further adapt itself according to the input signals in order to give the controller extra capability to handle highly nonlinear systems in different working conditions.

The auto-tuning FLC designed in this research has two inputs ( $V_{err}$  and  $dV_{err}$ ) and three outputs ( $G_{Verr}$ ,  $G_{dVerr}$  and  $G_{Vf}$ ) as shown in Figure (7).

Table (3 and 4) show the responses of the best designed FLC based exciters along with the DC1A exciter response during normal and fault working conditions.

## DISCUSSION

Table (3) shows that FLC based exciter with auxiliary auto-tuning FLC has less than half the ISE of the one without auxiliary FLC, and M-file FLC with auto-tuning has less than two percent the ISE of the one without auxiliary FLC.

Table (3) shows that FLC based exciter with auxiliary auto-tuning FLC maintained the extended critical clearing time of the one without auxiliary FLC (0.41 sec.) as the one without auxiliary FLC, while M-file FLC with auto-tuning has shorter critical clearing time (0.40 sec.).

### CONCLUSIONS

The results well justified the need of auxiliary auto-tuning controller by reducing both steady state absolute error of the generator terminal voltage ( $|V_{err}|$ ) and the maximum ISE.

The auxiliary auto-tuning without FLC has shortened the critical clearing time, while with auxiliary auto-tuning FLC maintained it as it is for the FLC based exciter without auto-tuning; which had made it very suitable exciter for the system during both faulty and normal working conditions.

### LIST OF SYMBOLS

$dV_{err}$	Change in error voltage.
$E_f$	The field excitation voltage on the stator side.
$r_e, x_e$	The external line resistance and reactance respectively.
$T_{em}$	The electro-mechanical torque developed.
$U$	Control signal.
$V_{err}$	Error voltage.

### LIST OF ABBREVIATIONS

FLC	Fuzzy logic controller.
ISE	Integral of square error.

### REFERENCES

- [1].Meier A. V., "Electric power systems a conceptual introduction", Wiley, 2006.
- [2].Custem T. V. and Vournas C., "Voltage stability of electric power systems", Springer, 2002.
- [3].Saadat H., "Power system analysis", McGraw-Hill, 1999.
- [4].ANSI/IEEE Std. 421.1-1986, "IEEE standard definitions for excitation systems for synchronous machines".
- [5].McNeill F. M. and Thro E., "Fuzzy logic a practical approach", Academic Press, Inc., 1994.
- [6].Banks W. and Hayward G., "Fuzzy logic in embedded microcomputers and control systems", Byte Craft Ltd., 2002.
- [7].EL-Hawary M. E., "Electric power applications of fuzzy systems", IEEE Press, 1998.
- [8].Abbas A. Y., "Synchronous generator transient voltage stability enhancement using fuzzy logic controller", M.Tech. Thesis, Electrical Power Techniques Engineering Dept., College of Electrical and Electronic Techniques, Foundation of Technical Education, 2011.
- [9].Ong C., "Dynamic simulation of electrical machinery using MATLAB/Simulink", Prentice Hall PTR, 1997.

[10].Hawas and Abbas, "Transient voltage stability enhancement using fuzzy logic controller techniques", The Engineering Conference of Control, Computers and Mechatronics, Baghdad, Iraq, January 2011.

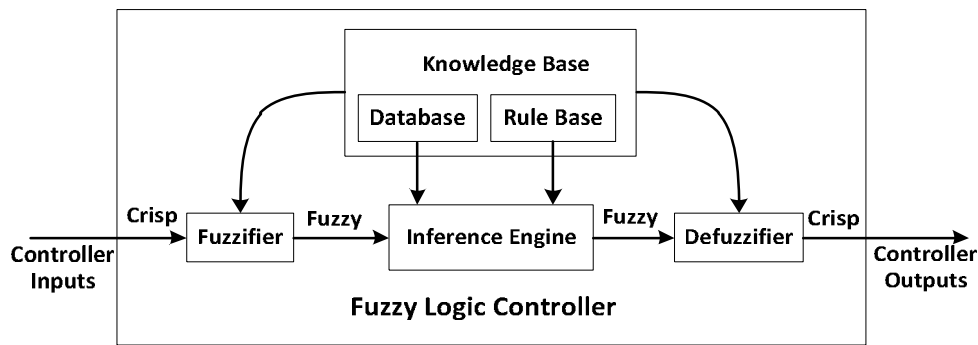

Figure(1) Schematic diagram of the FLC [7].

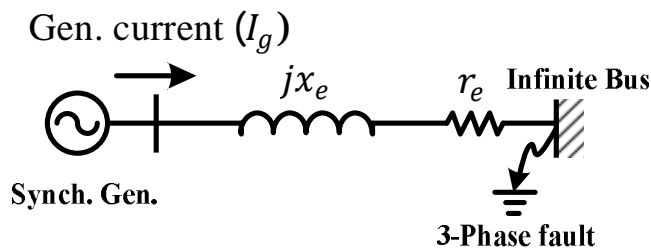

Figure (2) Synchronous generator connected to infinite bus subjected to 3- $\Phi$  fault.

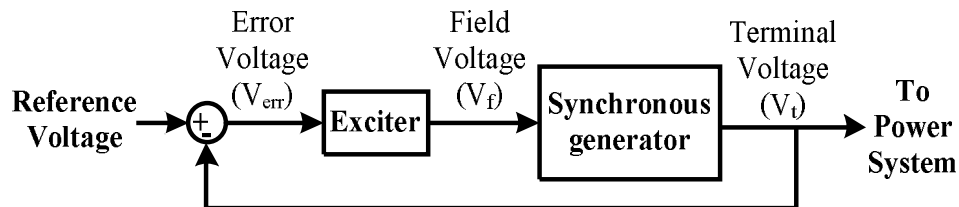

Figure (3) Synchronous generator terminal voltage control block diagram.

Table (1) the FLC based exciter rule base.

Where: NB-Negative Big, NM-Negative Medium, NS-Negative Small, ZE-Zero, PS-Positive Small, PM-Positive Medium, and PB-Positive Big.

$\frac{dV_{err}}{V_{err}}$	PBDV	PMDV	PSDV	ZEDV	NSDV	NMDV	NBDV
PBV	PBU	PBU	PBU	PBU	PMU	PSU	ZEU
PMV	PBU	PBU	PMU	PMU	PSU	ZEU	NSU
PSV	PBU	PMU	PMU	PSU	ZEU	NSU	NMU
ZEV	PMU	PMU	PSU	ZEU	NSU	NMU	NMU
NSV	PMU	PSU	ZEU	NSU	NMU	NMU	NBU
NMV	PSU	ZEU	NSU	NMU	NMU	NBU	NBU
NBU	ZEU	NSU	NMU	NBU	NBU	NBU	NBU

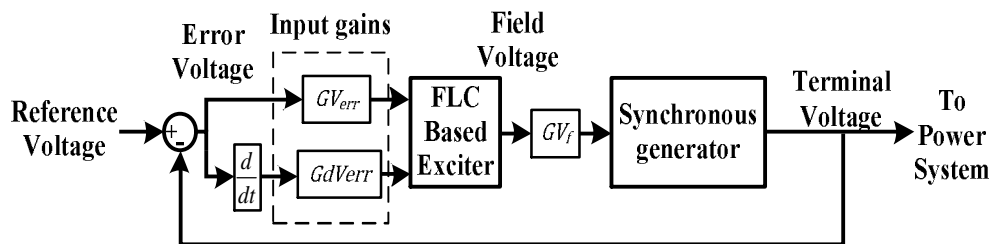

Figure (4) Synchronous generator with FLC based exciter.

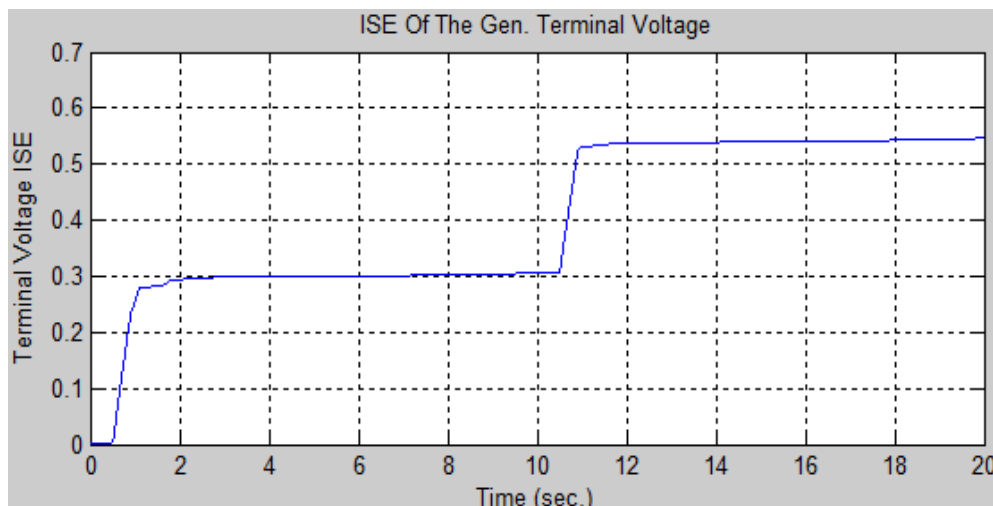

Figure (5) AISE of the terminal voltage of the generator with the best FLC based exciter for 0.41 second clearing time.

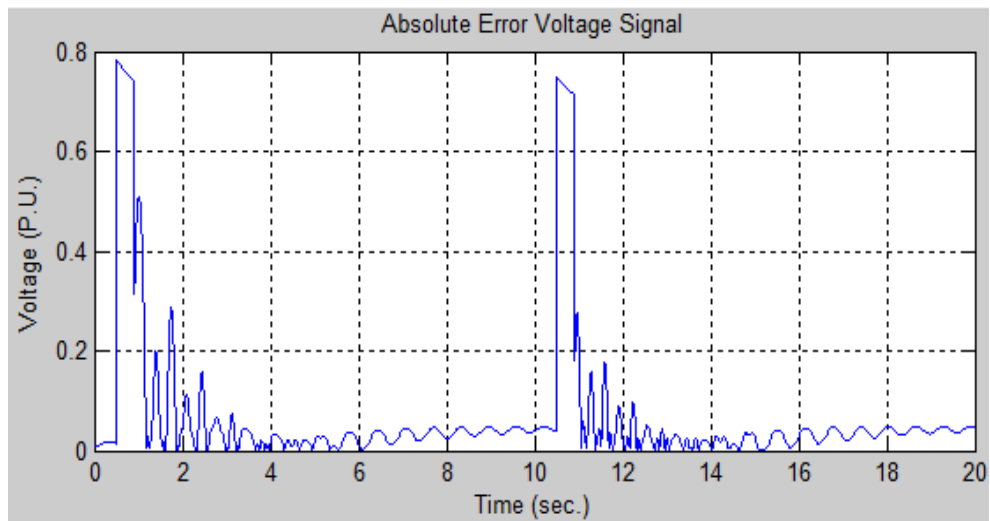

Figure (5) B Absolute error of the generator terminal voltage with the best FLC based exciter for 0.41 second clearing time.

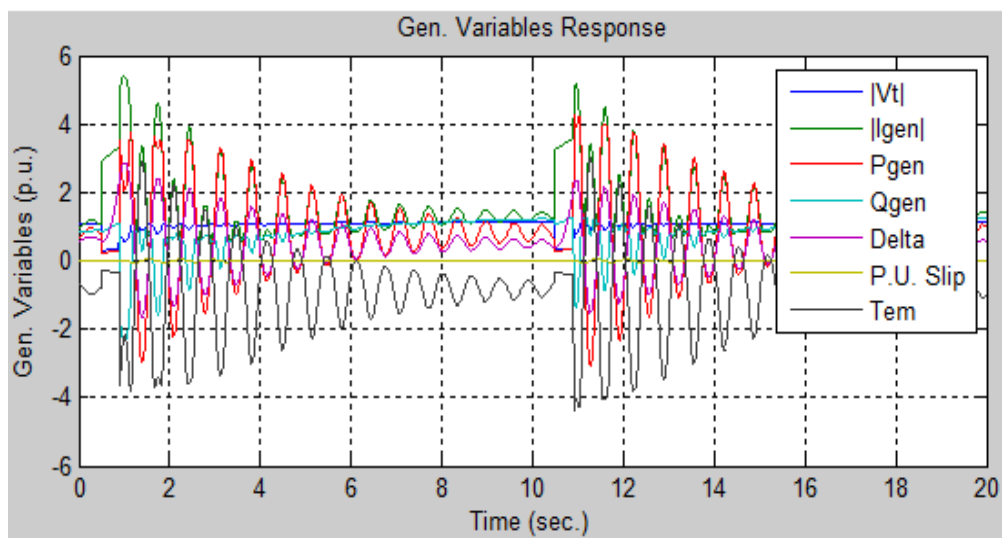

Figure (5) C Generator's variables response with the best FLC based exciter for 0.41 second clearing time.

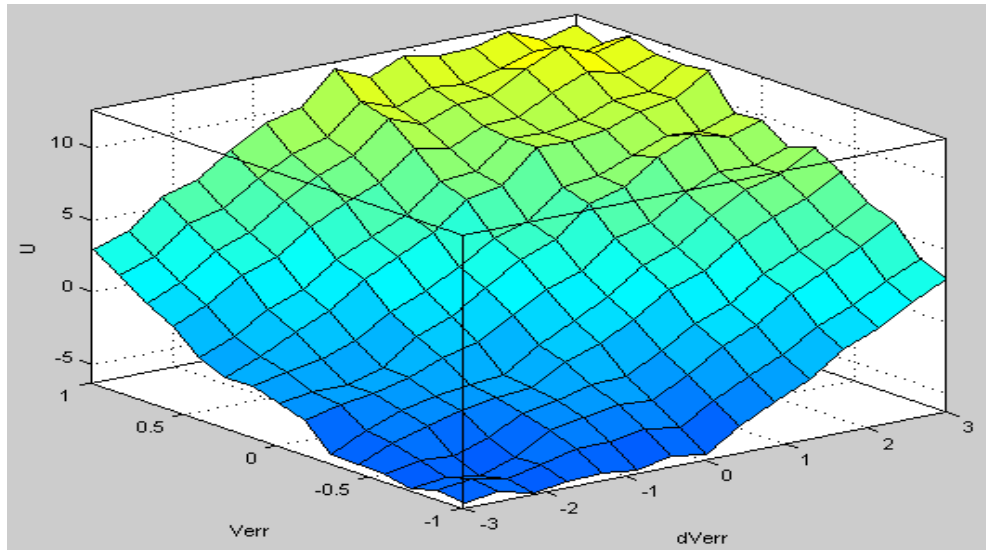

Figure (6) the control surface of the best designed FLC based exciter.

Table (2) Synchronous generator response during normal working conditions.

Controller Type	During Normal Working Conditions for 20 seconds period.	
	ISE Max	Steady State  Verr
Takagi-Sugeno with Gaussian membership function and weighted sum defuzzification method.	0.0375	0.046388
DC1A Exciter	0.000113	0.001753

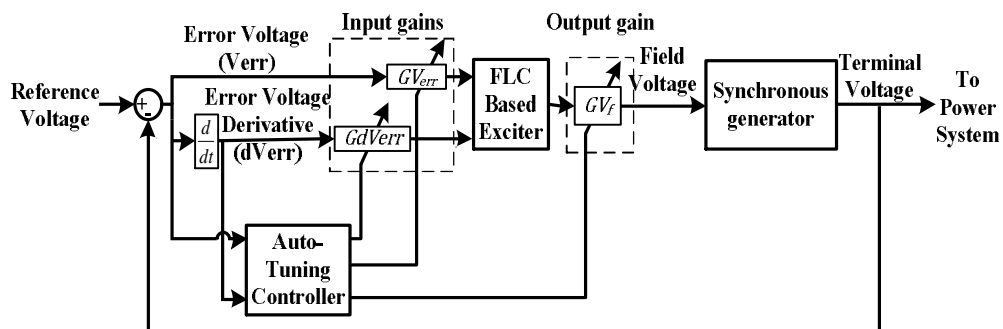

Figure (7) FLC based exciter with an auxiliary auto-tuning controller.



**Table (3) Synchronous generator response during normal working conditions.**

Controller Type	During Normal Working Conditions for 20 seconds period.	
	ISE Max	Steady State  Verr
Toolbox Takagi-Sugeno with Gaussian membership function and weighted sum defuzzification method without auxiliary auto-tuning FLC.	0.037500	0.046388
Toolbox Takagi-Sugeno with Gaussian membership function and weighted sum defuzzification method with auxiliary auto-tuning FLC.	0.014700	0.027846
M-file Takagi-Sugeno with Triangular membership function and WtAver defuzzification method with auto-tuning without FLC.	0.000509	0.0001366
DC1A Exciter	0.000113	0.001753

**Table (4) Synchronous generator response during fault working conditions.**

Controller Type	During Fault Conditions Response	
	Critical Clearing Time (sec.)	ISE Max
Toolbox Takagi-Sugeno with Gaussian membership function and weighted sum defuzzification method without auxiliary auto-tuning FLC.	0.41	0.5464
Toolbox Takagi-Sugeno with Gaussian membership function and weighted sum defuzzification method with auxiliary auto-tuning FLC.	0.41	0.5814
M-file Takagi-Sugeno with Triangular membership function and WtAver defuzzification method with auto-tuning without FLC.	0.40	0.5611
DC1A Exciter	0.32	0.4668