

## Experimental and Finite Element Analysis on Rounded Corners Square Shape Tube Hydroforming Process

**Dr. Hani Aziz Ameen**

Technical College, Foundation of Technical Education/Baghdad

Email:haniazizameen@yahoo.com

**Dr. Nahedh Mahmood Ali**

Materials Engineering Department, University of Technology/Baghdad

Received on: 28/1/2014 & Accepted on: 13/5/2014

### ABSTRACT

Tube hydroforming is a forming process where an inner pressure combined with axial feeding deforms the tube to the shape of a die cavity, i.e. the process state where the hardening of the material is unable to resist the increase in inner pressure and wall thickness reduction. In the current work the tube with circular cross section is deformed to square cross section using hydraulic pressure. The die of the square edges is designed and manufacturing to change the tube with circular cross section to square cross section. The die and tools were designed and manufactured in order to satisfy the experimental work. The hydraulic system manufactured is capable to give several values of internal pressure. Initially circular tubes are inflated against a square die while simultaneously they are axially compressed in order to delay wall thinning and burst and achieve an accept tube wall thickness distribution. The dimension of tube used in the experimental work of copper is ( $L=110$  mm,  $d_o=9.4$  mm ,  $t_o=1.5$ mm) to obtain forming limit diagram and mechanical properties of tube and value of the bursting pressure and final thickness for copper tube (170MPa ) and 1.18 mm. A squared grid has been printed by screen method with dimensions (5x5mm) the strain measurement accomplished by measuring the dimensions of the grid printed before and after deformation. The finite element method was applied via ANSYS11 software package in order to determine the tube thickness, stress and strain behavior and the internal pressure required to form the square shape tube and the radius of curvature of the tube. It was found that the generated strain during the tube hydroforming process in the square cross – sectional die was less than that in ANSYS software within 20%. The results showed good agreement.

**Keywords:** Tube Hydroforming, Finite element method, ANSYS, Bulging, Square cross section Tube

### دراسة تشكيل الانابيب مربعة المقطع ذات الحواف الدائرية عمليا وباستخدام طريقة العناصر المحددة

#### الخلاصة

عملية تشكيل الانبوب باستخدام التشكيل الهيدروليكي هو عملية تشكيل باستخدام ضغط السائل الداخلي جنباً إلى جنب مع القوى المحورية الى ان يأخذ الانبوب شكل القالب، بمعنى ان المعدن غير قادر على مقاومة الزيادة في الضغط الداخلي ونقصان سمك الجدران. في بحثنا هذا تم تحويل الأنبوب ذو المقطع العرضي الدائري الى مقطع عرضي مربع باستخدام الضغط الهيدروليكي. تم تصميم وتصنيع قالب ذو حواف مربعة لتغيير مقطع

الانبوب من الدائري الى المربع. و باسلوب يناسب الاجراءات العملية. ان النظام الهيدروليكي المصنع قادر على إعطاء عدة قيم من الضغط الداخلي. بدءاً عند تسليط الضغط يحدث انتفاخ للانبوب الدائري ليأخذ شكل القالب المربع، بينما في الوقت نفسه يكون مضغوط محورياً من أجل تأخير التشققات في جدار الانبوب وتحقيق توزيع للسمك على جدار الانبوب. لقد تم استخدام انبوب من النحاس ذو ابعاد ( الطول 110 ملم، القطر الخارجي 9.4 ملم وسمك 1.5 ملم) للحصول على سمك نهائي للانبوب 1.18 ملم و يضغط 170 MPa. حيث استخدمت شبكة ذات مربعات ( 5 × 5 ملم ) وتم قياس الانفعال قبل وبعد التشوه باستخدام هذه التقنية. تم تطبيق طريقة العناصر المحدودة من خلال برنامج ANSYS11 من أجل تحديد سماكة الأنبوب ، والإجهاد و الانفعال و الضغوط الداخلية اللازمة لتشكيل الأنبوب الى شكل مربع، وايضا تم دراسة نصف قطر انحناء حافة الأنبوب. تم مقارنة الانفعالات المتولدة خلال عملية التشكيل عمليا ونظريا ووجد انها تقل بنسبة 20% عن نتائج المستحصلة ببرنامج ANSYS. أظهرت النتائج توافقاً جيداً.

## INTRODUCTION

The process of tube hydroforming has gradually comes into use over the last half decade for manufacturing aircraft and automobile components.

The advantages of hydroforming include reduced tooling cost, reduced finishing cost on formed part, excellent material utilization, fewer operations and improved part quality [1]. Hydroforming is the fabrication process that uses a fluid medium to form a piece by using high internal pressure. A tubular blank is placed between two dies, sealed and pressurized fluid up to certain pressure is injected. Deforming the tube walls in the cavity form of dies. Tube hydroforming is a relatively modern forming process for shaping initially circular tubes into structural members of chosen longitudinal and cross-sectional shapes. There have been numerous studies on the hydroforming process like T-shape tube hydro forming process, expanding the diameter of the pipe and convert the cross section from shape to other shape. Asnafi et al(2000)[2] proposed a mathematical model to predict the internal forming pressure and the associated feeding stroke needed for hydro forming a T-shape tube product without wrinkling or bursting, Lei et al (2001)[3] developed a three dimension finite element program based on the rigid-plastic model for analysis and design of the tube hydro forming process with eight isoparametric brick element, Kwan et al (2004)[4] developed the Die shape for T-shape tube hydroforming where two design methods for T-shape tube hydroforming dies are proposed, namely, the extrusion-cutting-fillet method and inter section fillet method a qualified product of T-shape tube, without wrinkling or bursting. Jorge et al (2006)[5] studied the behavior of an aluminum tube when submitted to the hydroforming process, the simulation via finite element method of two hydroforming process is made. Mikael et al(2007)[6] studied an iterative optimization problem and adaptive simulation procedure based on process response approximation is proposed to the tube-hydro forming process. Hwang et al (2007)[7] studied a hydro forming test machine designed and developed for tube hydroforming process using annealed AA6063-TS and 6011A aluminum tube experiments of bulge forming and T-shape hydroforming. Yannis P. Korkolis and Stelios Kyriakides(2011)[8] and [9] presented an experimental investigation of hydroforming of Al-6260-T4 tubes and a simple two-dimensional model of the process. Relatively long, extruded circular tubes were formed against a square die with rounded corners, with simultaneous application of axial feeding. Also they presented fully 3D models of the process that include friction as well as more advanced constitutive models shown in previous studies to be essential for simulation of burst in free hydroforming of aluminum alloy tubes.

Process of Tube Hydroforming

In this paper, the closed die is used for tube hydroforming. As shown in Figure(1).

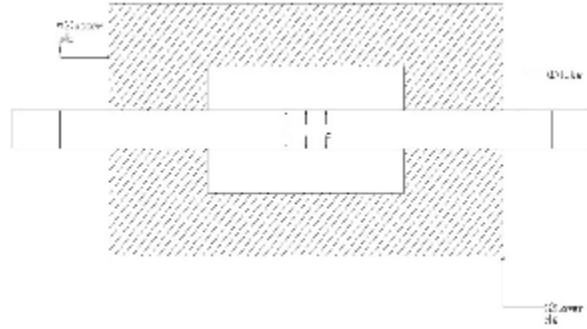

Figure (1):The tube with lower and upper dies

From Figure1, the tube (1) is placed at cavity lower die, the split dies are closed in order to avoid movements of the tubular blank. As a further action the tubular blank is fulfilled with the fluid medium through the sealed washer and internal pressure loading is applied. In this paper the experiments performed on copper tube. The specimen material of this work is a copper tube of commercial standards ASTM B280 and its purity was determined by spectrometer analysis by atomic absorption and found 99.924 copper. Other specimen material was as shown in table(1).

Table (1) The chemical composition of specimen

Pb	Zn	Fe	Ni	Co	Cd	Si	Mn	Ag
0.01	0.002	0.003	0.02	0.005	0.001	0.005	0.001	0.002
Sn	Cr	P	S	As				
0.002	0.005	0.015	0.002	0.003				

In order to determine the mechanical properties of copper tube, the tensile test is achieved, from this test the important mechanical properties of tube material are obtained which can be used in numerical and experimental tests like yield stress, Modulus of Elasticity, ultimate stress and tangent modulus as follows :Yield stress ( $\sigma_y$ ) = 45MPa, Modulus of Elasticity (E) =124GPa, Tangent Modulus of Elasticity ( $E_t$ ) =0.8GPa, Poisson’s Ratio( $\nu$ )=0.34. In this study, a relatively long circular tube is formed into a square section.

Design Calculations of the Hydroforming Die

The main role in current calculation is to determine the loads that affect on the hydroforming die, which is the pressure (P) and axial force (F) of the fluid medium as shown in Figure(2)that exert on the die[10].

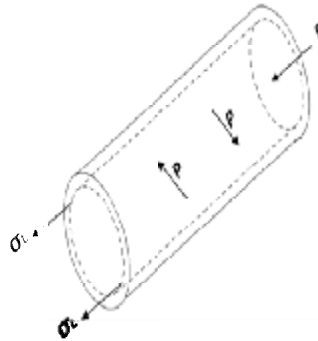

Figure (2):The main load which exerting on the tube, that transfer to the die.

The stresses that caused from these loads are the longitudinal stress ( $\sigma_L$ ) and circumferential stress ( $\sigma_\theta$ ).

From equilibrium forces (Figure(2)) it can be deduced that

$$\sigma_L \cdot 2\pi r t_0 = F + P \pi r^2 \quad \dots (1)$$

where,  $r$  is the radius of the tube and  $t_0$  is the thickness of the tube

Eq.(1) can be rearranged

$$\sigma_L = \frac{F}{2\pi r t_0} + \frac{P r}{2 t_0} \quad \dots (2)$$

the equilibrium forces in the circumferential direction will be

$$\sigma_\theta \cdot 2t_0L = P \cdot 2rL \quad \dots (3)$$

where  $L$  is the length of the tube. Hence Eq.(3) can be rearranged to get

$$\sigma_\theta = \frac{P r}{t_0} \quad \dots (4)$$

thus, there is no load in the radial direction, so  $\sigma_r = 0$

Now, the effective stress that affect on the tube wall due to the internal pressure and axial forces can be get from Von Mises yield criteria as shown in Eq.(5).

$$\bar{\sigma} = \frac{1}{\sqrt{2}} \sqrt{(\sigma_L - \sigma_\theta)^2 + (\sigma_\theta - \sigma_r)^2 + (\sigma_r - \sigma_L)^2} \quad \dots (5)$$

our data are :

thickness ( $t_0$ ) = 1.5mm ,  $r$ = 9.4mm,  $P$  = 50 bar ,  $P$ =  $50 \times 10^5$  pa,  $P$ =5Mpa

$F = P \cdot 2 \pi r t_0 = 5 \times 10^6 \times 2 \pi \times 0.0094 \times 0.0015 = 442.74$  N

substituting in Eq.(2) gives,  $\sigma_L = 20.7 \times 10^6$ Pa= 21 Mpa

substituting our data in Eq.(4) gives  $\sigma_\theta = 47$  MPa and  $\sigma_r = 0$

substituting the value of the  $\sigma_L$  ,  $\sigma_\theta$  and  $\sigma_r$  into Eq.(5) , gives

$$\bar{\sigma} = \frac{1}{\sqrt{2}} \sqrt{(21 - 47)^2 + (47 - 0)^2 + (0 - 21)^2}$$

$$\bar{\sigma} = 81.57 \text{ Mpa} , \bar{\sigma} = 82 \text{ Mpa} = P$$

This is representing the pressure exert on the upper and lower dies shown in Figure(3).

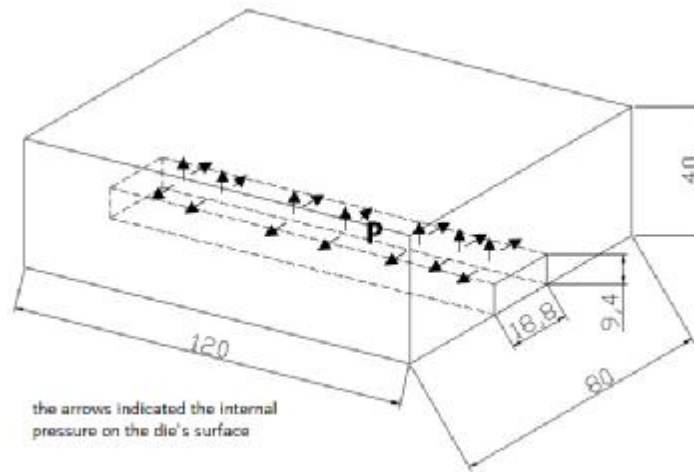

**Figure (3): The loads exert on the die.**

According to the calculated forces, it can be deduced that the max pressure is 246MPa with factor of safety equal 3 . So according to the current calculation, the following dimensions are used for the die:

Length of the die = 120 mm, Width of the die = 80 mm, Height of the upper and lower part = 40 mm.

Hence, the Dimensions of the cavity (square section) will be Length=120, width=18.8 and height of the upper and lower part= 9.4mm)

The Stresses inflicted by the pressure on the tube and transferred to cavity's die (248MPa) with factor of safety 3, is less than the yield stress of the die material ( $\sigma_y$ ) in which the low carbon steel (250 Mpa). So the dimensions that are developed for the die can be resistance the loads applied on the die without happening crack and broken the die.

On the other hand if the forming pressure is calculated on the tube, the thickness of the tube can be determined[11].Due to forming the thickness is changed theoretical from 1.5mm to 1.18mm and the forming load is calculated as follows:

$2tR = \frac{\pi}{2} R t_0 \dots$  where the  $t$  is the final thickness

$$t = \frac{\pi t_0}{4} = \frac{\pi * 1.5}{4 * 1000} = 0.001175 \text{ m} \approx 1.18 \text{ mm}$$

$$\bar{\epsilon} = \frac{2}{\sqrt{3}} \epsilon_\theta = \frac{2}{\sqrt{3}} \ln \frac{t_0}{t} = \frac{2}{\sqrt{3}} \ln \frac{1.5}{1.18} = 0.277$$

$$\sigma_\theta = \frac{2}{\sqrt{3}} K \bar{\epsilon}^n = \frac{2}{\sqrt{3}} * 800 * 10^6 * (0.277)^{0.33} = 605 \text{ MPa}$$

$$P = \frac{\sigma_\theta \cdot t}{R} = \frac{605 * 10^6 * 1.18 * 10^{-3}}{9.4 * 10^{-3}} = 75.94 \text{ MPa, Hence, } P = 76 \text{ MPa}$$

the dimension bearing 82 MPa(effective load) and forming load (76MPa) in which the yield of mild steel is approximately (250 MPa). So the factor of safety equal to 3 is used that ensures no failure in the dies.

**Design of the Hydroforming Die**

In order to passing the difficulties for getting the product, the die is made from two parts which consists of two main forming dies (upper and lower) and provide plungers for the axial feed actuators. The SOLIDWORK program is implemented to achieve the die design. During forming, the dies (upper and lower) are held together by 4 bolts as shown in Figure(4). The hydroforming dies are made of mild steel and have overall dimensions shown in Figure(5).

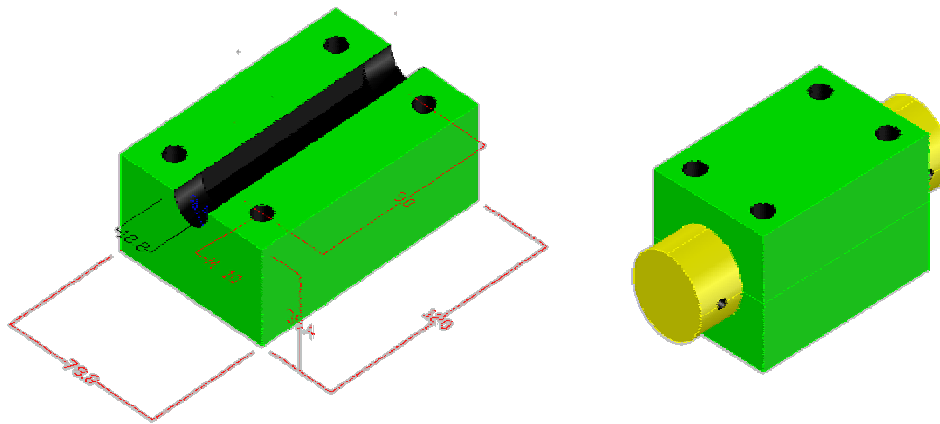

Figure(4): Shows the upper and lower dies

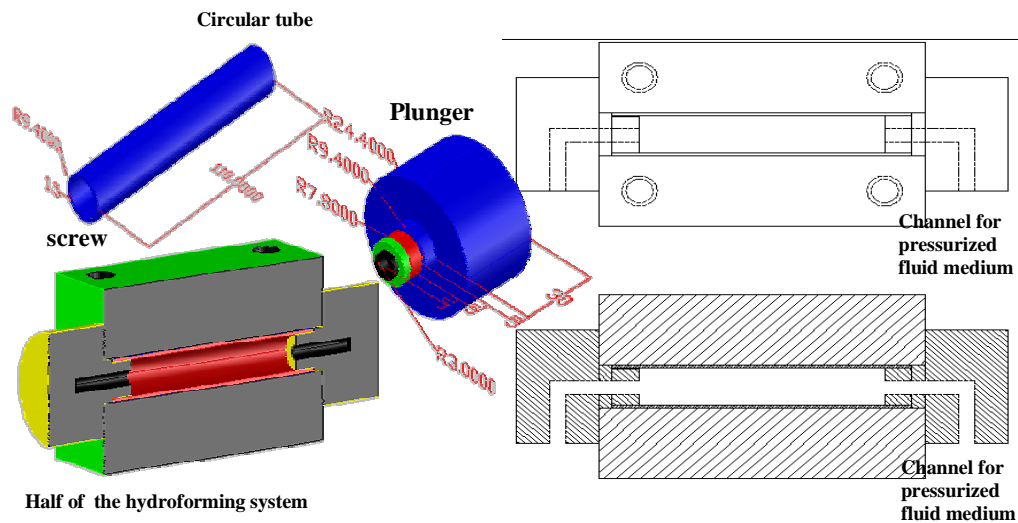

Figure(5):Shows the details of hydroforming system for square cross section.

**Manufacturing Process of the Hydroforming Die**

The hydroforming die is made from mild steel , the parts of the die are designed by the milling machine then using the drilling to making the four holes, and then using dies to make the threading. The two plungers parts are made by lathe machine and then making holes by drilling machine.(as shown in Figure(6)).

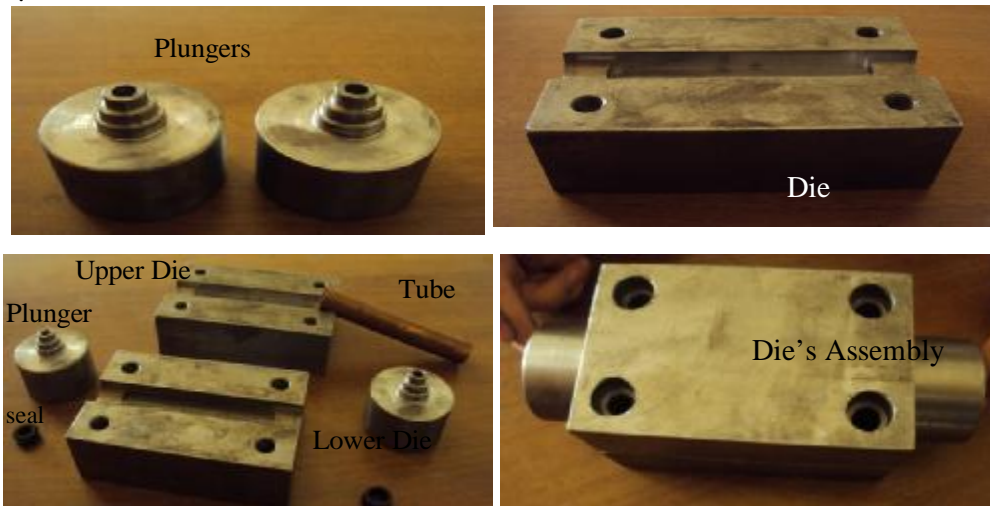

**Figure(6): Hydroforming die for square cross section.**

Seals are an important part of in the hydraulic system[12]. Figure(7), shows the two lips seal, that is using in our hydraulic system



**Figure (7):Two lips seal.**

**Tube Hydroforming System**

Because of high cost of hydraulic pump, so a car jack is redesigning and remanufacturing and reversing its operation, it can achieve high internal pressure by squeezing the hydraulic inside tube. Figure(8) shows the die with the hydraulic system .



**Figure (8):Shows the die with the hydraulic system.**

Figure (9) shows the experimental final tube formed of copper by internal pressure 170MPa.



**Figure (9): Final tube formed of copper.**

### **Finite Element Modeling**

ANSYS, finite element analysis, software package with capability to analyze a wide range of different problems is a powerful numerical technique, has been applied in the past years to a wide range of engineering problems. Although much FE analysis is used to verify the structural integrity of designs, more recently FE has been used to model fabrication processes. When modeling fabrication processes that involve deformation, the deformation process must be evaluated in terms of stresses and strain states in the body under deformation including contact issues[13]. A numerical control algorithm is described that predicts the internal pressure loads to give maximum formability of circular tubes during hydroforming. The controller tracks the stresses, strains and mechanical response of the incremental .finite element solution to estimate the proper internal pressure increments to apply in the next increment as the tube deforms. The algorithm uses the material stress–strain curve and the deformation theory of plasticity to relate the current stress and strain increments (from the FEM) to the next applied load increments. A controlled increment in plastic strain is prescribed for the next solution increment, and the pressure increments are calculated [14].Static stress analysis with nonlinear material models enables the study of stress, strain and



displacement in systems that have geometric and material nonlinearities but no appreciable motion. In this type of analysis, loading can cause large deformation, permanent deformation beyond the material yield point and residual stresses. Damping and mass effects are ignored due to the absence of motion; however, contact between parts of a mechanism or among independent parts can be handled. Nonlinear static stress analyses produce more accurate stress results than linear static stress analyses. Plane stress condition with thickness is achieved. The die represented by (Target 169), and defined as a very rigid body and the tube blank material represented by (Plane182), which is defined by four nodes having up to three degrees of freedom at each node. The contact interface between die and the deformed material is represented by (Contact 171), which has two degrees of freedom at each node. Due to symmetry quarter is meshed, as shown in Figure(10).

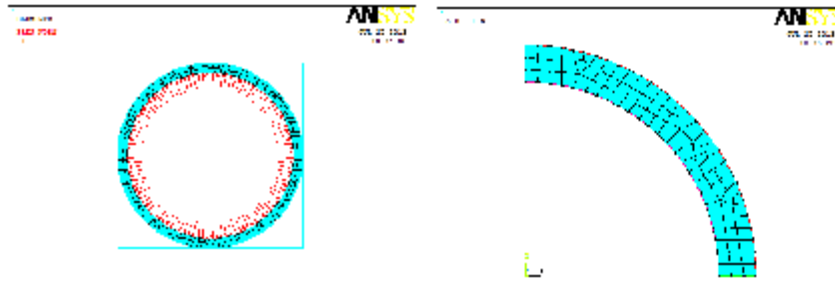

**Figure (10): Tube hydroforming process modeling**

The internal pressure represented in this modeling by a uniform distributed pressure is applied as a stepped load on internal line of axisymmetric 2-D. In this modeling MAPPED meshing was used , also several simulation tests were done to know the effect of increasing number of elements on results accuracy as shown in Figure10.The following steps are the APDL for the bulging tube.

```

/prep7
! Die
k,1,0,0 $ k,2,9.4,0 $ k,3,9.4,9.4 $ k,4,0,9.4 $ L,4,3 $ L,3,2
! Blank $ cyl4,0,0,9.4,0,(9.4-1.5),90
! blank $ ET,1,182 $ KEYOPT,1,3,3 $ R,1,120 $ MP,eX,1,124e3 $ MP,nuXY,1,0.34
tb,biso,1 $ tldata,1,45,0.8e3
! meshing the Blank $ type,1 $ mat,1 $ real,1 $ esize,0.5 $ amesh,1 $ allsel,all
! contact $ ! using contact manager $ allsel,all $ finish
/config,nres,10000
/solu $ Lsel,s,,,4 $ nsl,s,1 $ D,all,ux $ Lsel,s,,,6 $ nsl,s,1 $ D,all,uy
*do,I,1,170,1 $ lsel,s,,,5 $ nsl,s,1 $ sf,all,pres,I $ allsel $ nlgeom,on $ outre,all,all
outpr,all,all $ nropt,full $ nsubst,10 $ cnvtol,u,0.25,.1 $ NEQIT,99 $ eqslv,sparse
solve $ *enddo $ finish $ /post1 $ Plnsol,S,Eqv $ finish
    
```

### Results and Discussion

The image processing technique can be used to measure the strain by analysis of the grid which was printed on surface. Table (2) shows the different between the

tangential and radial strain,  $\epsilon_{\theta}$  and  $\epsilon_r$ . The experimental was carried out on copper, a square grid was etched on tube to measure the hoop and the longitudinal strain at the end of process. The bulge area is plastically deformed. During the test the axial actuators are still and the tube is fully blocked. The experiment design starts from the observation of the tube bursting pressure and yield pressure. The results are shown in the table(2).

**Table (2) Results of the tube hydroforming**

Pressure [MPa]	Experimental results		ANSYS Results		% discrepancy	
	$\epsilon_{\theta}$	$\epsilon_r$	$\epsilon_{\theta}$	$\epsilon_r$	$\epsilon_{\theta}$	$\epsilon_r$
10	0.156679	-0.04082	0.125343	-0.03306	20.00013	19.01029
20	0.155596	-0.04779	0.124477	-0.03871	19.99987	18.99979
30	0.154512	-0.05481	0.12361	-0.0444	19.99974	18.99288
40	0.153427	-0.06899	0.122742	-0.05588	19.99974	19.00275
50	0.152341	-0.07616	0.121873	-0.06169	19.99987	18.99947
60	0.151253	-0.08338	0.121002	-0.06754	20.00026	18.99736
70	0.150164	-0.09065	0.120131	-0.07343	20.00013	18.99614
80	0.149075	-0.09798	0.11926	-0.07936	20	19.00388
90	0.147983	-0.10536	0.118386	-0.08534	20.00027	19.00152
100	0.146891	-0.1128	0.117513	-0.09137	19.99986	18.99823
110	0.145798	-0.12029	0.116638	-0.09743	20.00027	19.00407
120	0.144703	-0.13544	0.115762	-0.10971	20.00028	18.99734
130	0.143607	-0.1431	0.114886	-0.11591	19.99972	19.0007
140	0.14251	-0.22314	0.114008	-0.18074	20	19.00152
150	0.141412	-0.23995	0.11313	-0.19436	19.99972	18.99979
160	0.140312	-0.04082	0.11225	-0.03306	19.99971	19.01029
170	0.139211	-0.04779	0.111369	-0.03871	19.99986	18.99979

**Stress, Strain, Deformed Shape and Contact Pressure Distribution**

Figures.(11,12,13 and 14) show the contours of the distribution of Von Mises stress, strain, deformed shape and contact pressure in the final formed copper tube in hydraulic bulge test. It can be seen from Figures.(11) and (12) that the maximum Von Mises stress and strain are located in the pole of the tube. Table(3) shows the variation of Von Mises stress with internal pressure.

Figure(13) shows the tube thickness and location of thinning along its bulged part. The minimum simulated thickness of tube (1.08 mm) while it is reduced from 1.5 mm to 1.18 mm by experimental test at pressure 170MPa, the variation between simulated and experimental test result is 8.47% .

Fig. (15) show the relationship between internal pressure and bulge height in tube hydroforming in square die.

**Table(3) Von Mises stress with internal pressure**

Internal Pressure (MPa)	Von Mises Stress (MPa)
40	156.947
60	233.551
100	266.655
130	282.24
150	294.918
170	310.049

**Corner Radius**

The final corner radius for square cross- section tube was measured from the hydroformed experimental samples and were compared with the simulation results. Table(4) shows the results of the final corner radiuses.

**Table(4) Corner radius comparison of copper tube.**

Corner radius		
Experiment (mm)	ANSYS (mm)	% discrepancy
2.84	2.72	0.704225

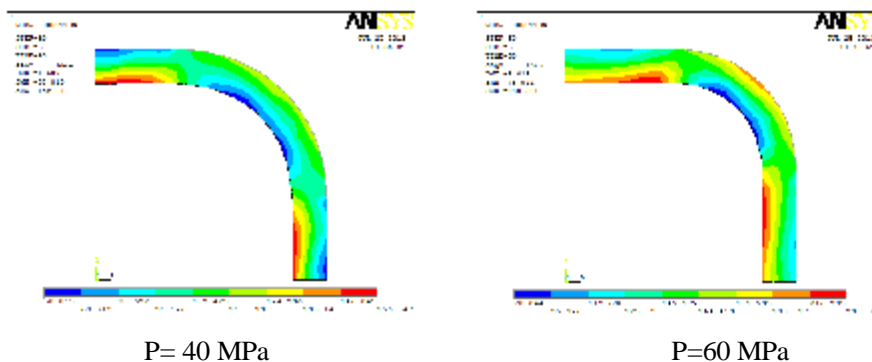

**Figure (11) to be continued**

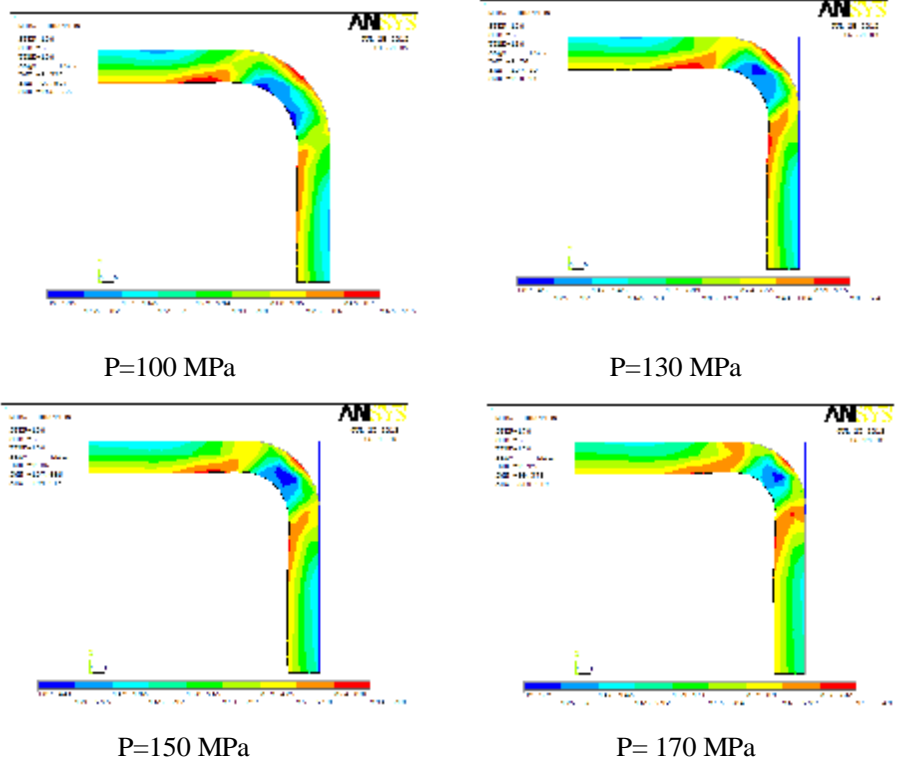

Figure (11): Effective stress distribution in the bulging tube.

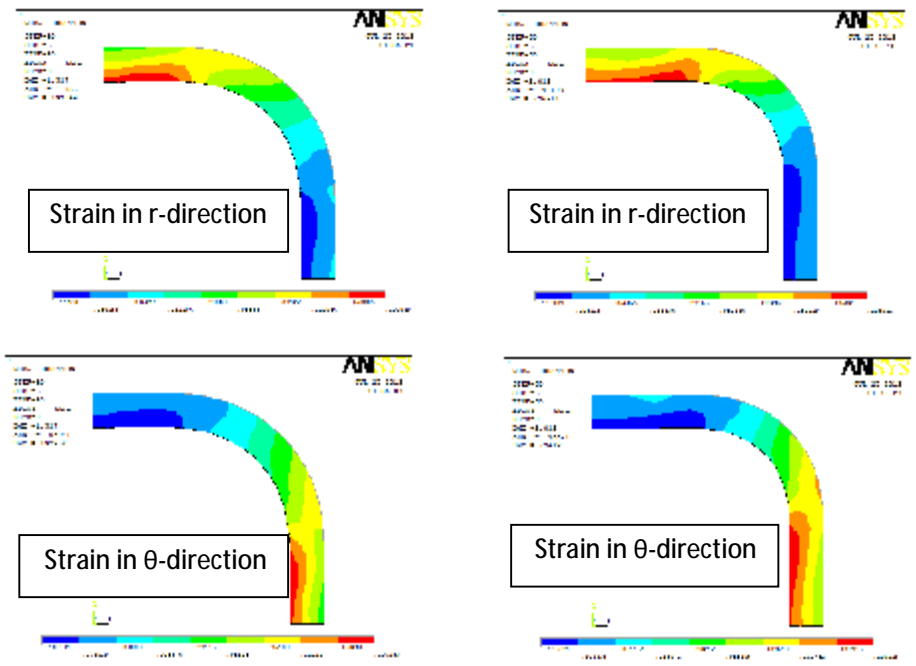

Figure (12) to be continued

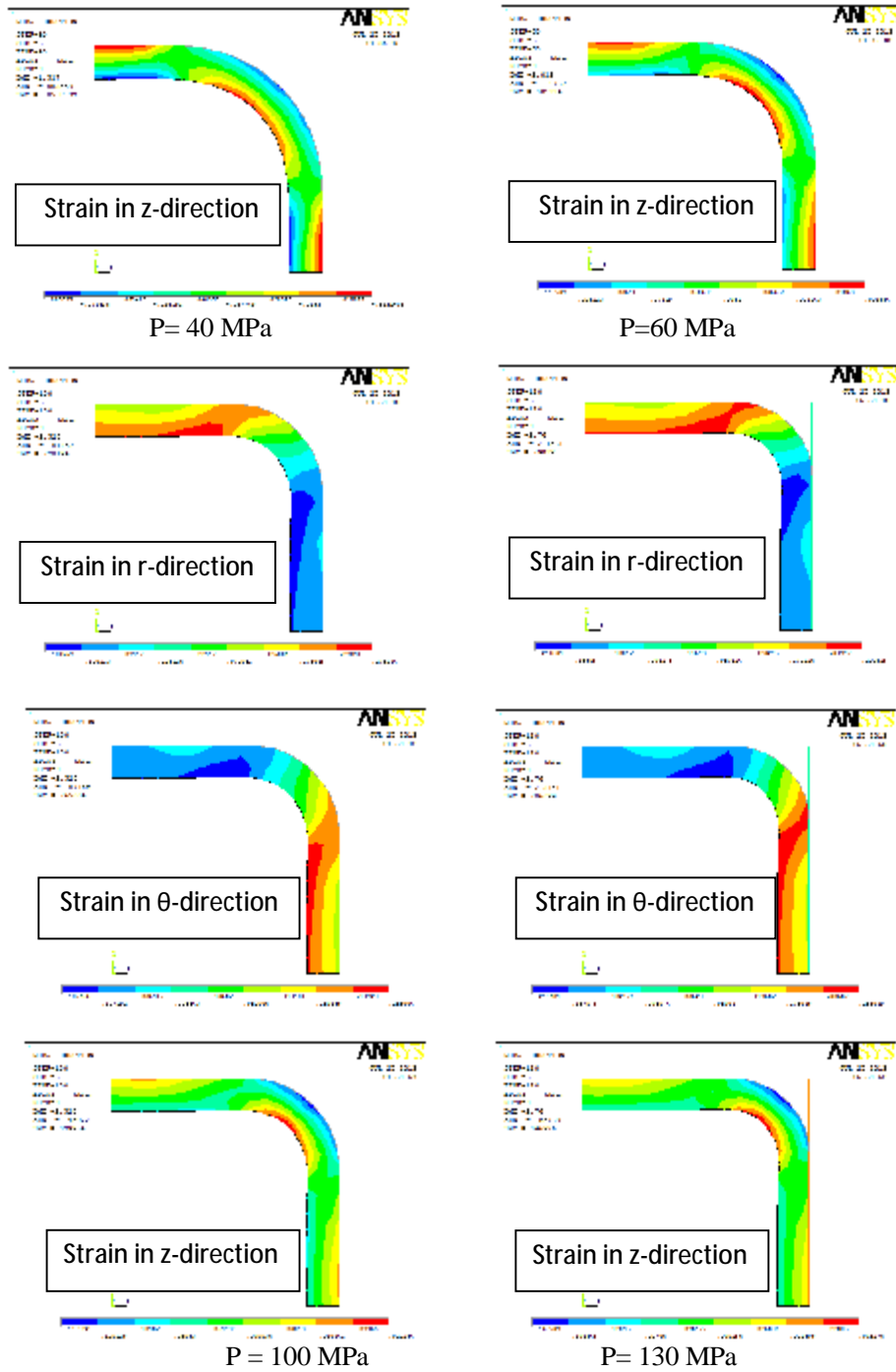

Figure (12) to be continued

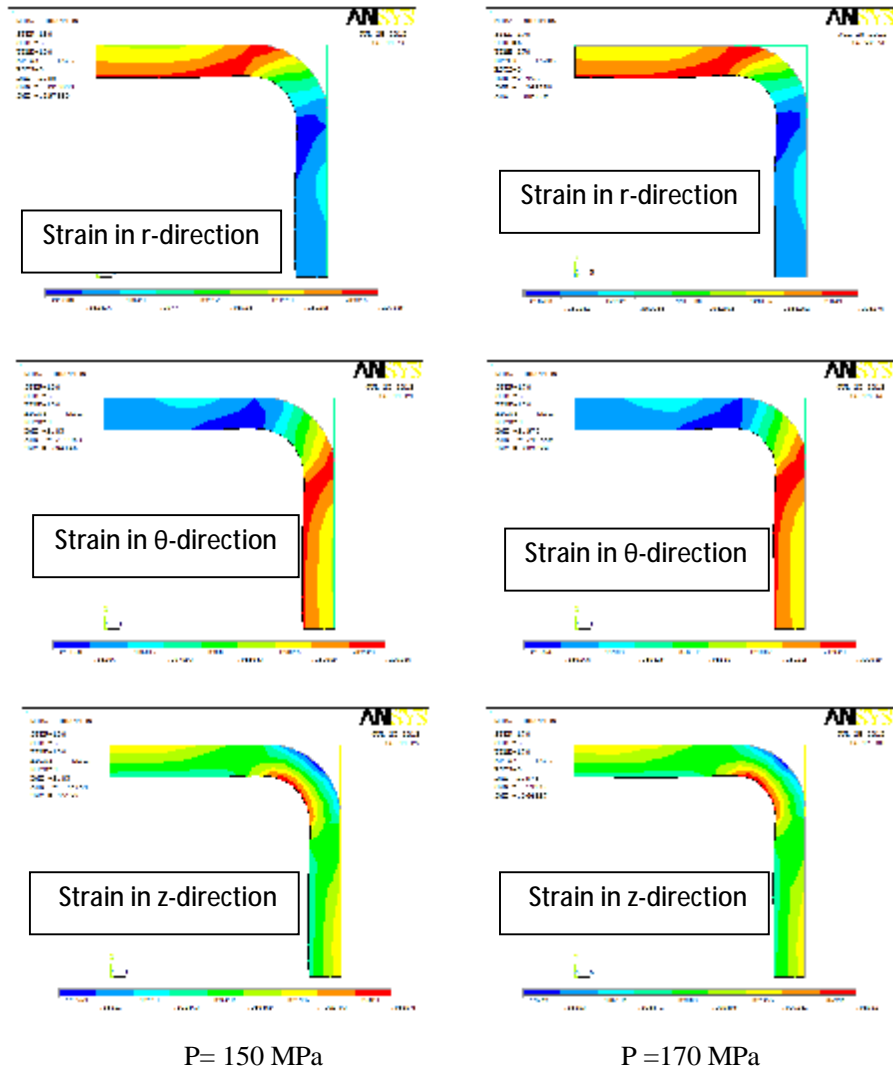

Figure (12):Strain distribution in the bulging tube in r,  $\theta$ , and z direction

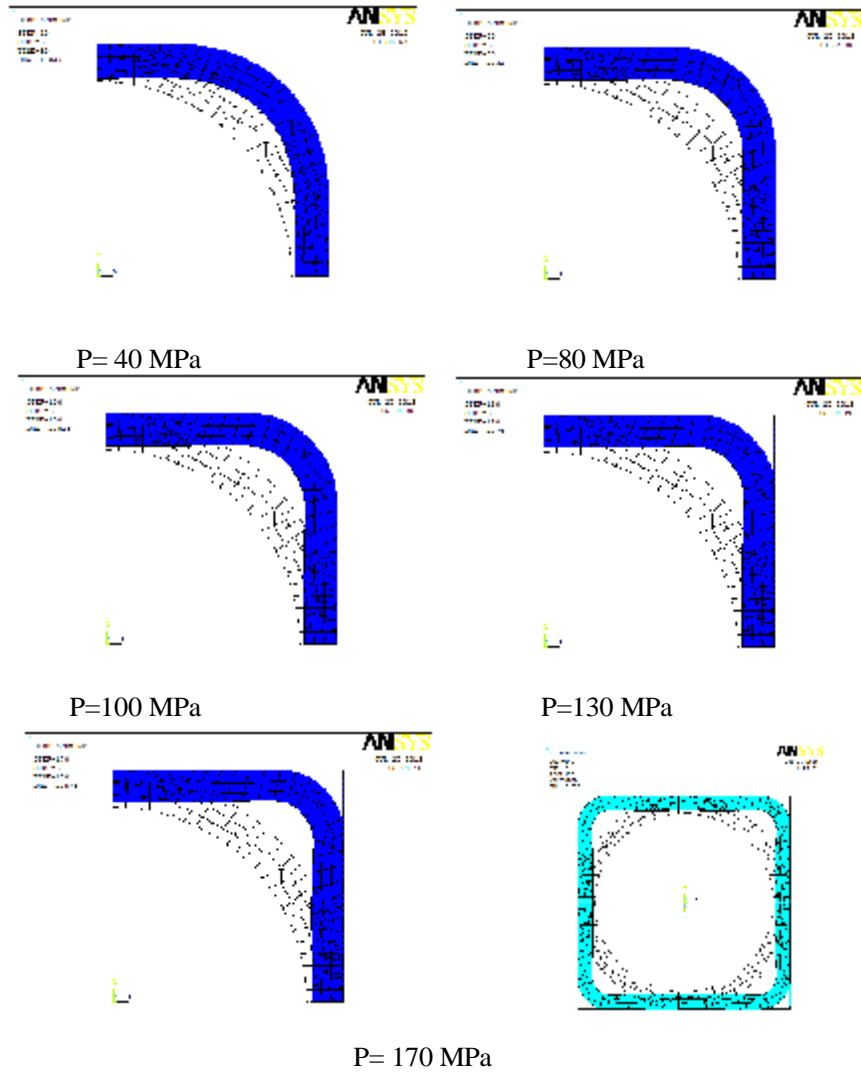

Figure (13) The deformation of the tube during bulging, show the change of the tube wall thickness.

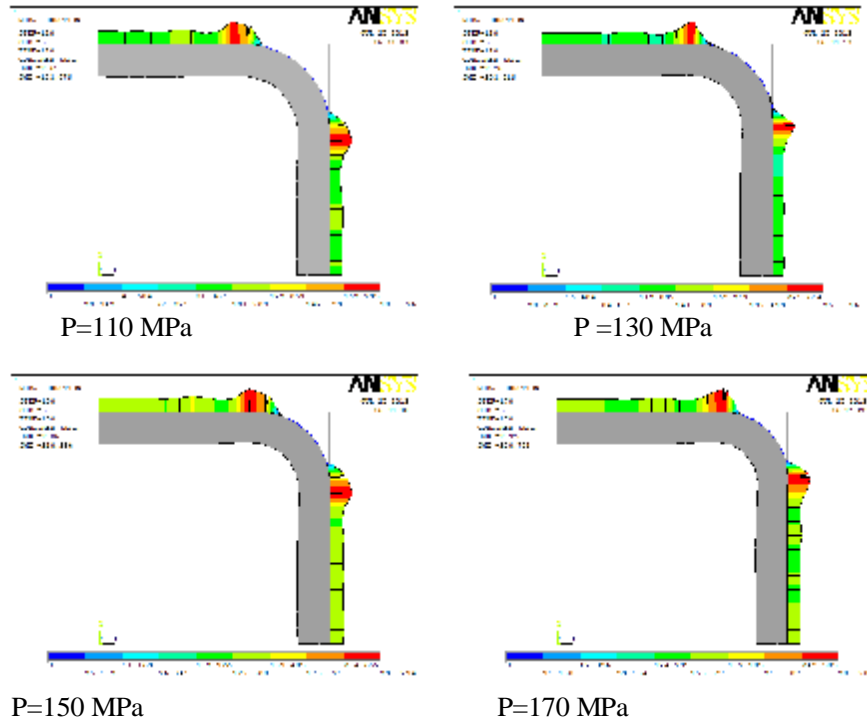

Figure (14): Show the contact pressure between the tube wall and the die

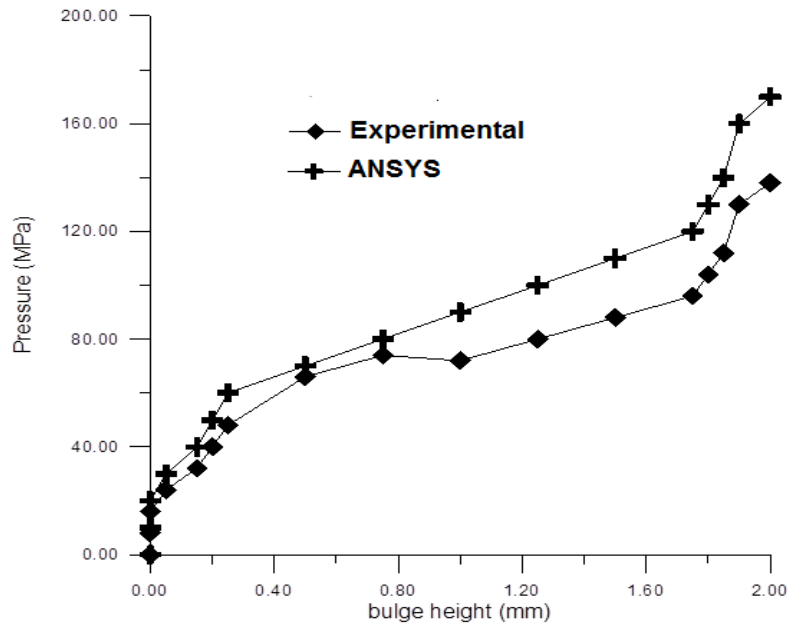

Figure (15):Relationship between internal pressure and bulge height



## **CONCLUSIONS**

- 1- Hydroforming with feeding is strongly sensitive to loading path, i.e. the relationship of the internal pressure and bulge height.
- 2- The thickness of the tube in decrease 21% compared to the initial thickness .
- 3- The variation of the radial strain was 1.7468% during the process and 0.697% for circumferential strains with discrepancy about 20%.
- 4- The total Von Mises stresses are duplicated increased with the increasing of internal pressure .

## **REFERENCES**

- [1]DohmannF.,Hartl C.,"Hydroforming a method to manufacture light weight parts ",*J. Mater. Process Tech.*,60,pp669-675,1996 .
- [2]Asnafi N., SkogsgardhA.,"Theoretical & experimental analysis of stroke controlled and hydroforming", *J.Mater Sci.Eng.*,A279,pp 95-110,2000.
- [3] Lei LP et.al,"Analysis and design of hydroforming processes by the rigidplastic finite element method",*J. Mater process Tech.*, 114,pp201-206,2001.
- [4]Kwan C.T. , Lin C.Y. ,Luo Y.S. ,Hu w.b. , JauT.C.,"Die shape design for T-shape tube hydroforming",*Int. J. Adv. Manuf. Techanol*, 23 ,pp169-175,2004.
- [5]Jorge PaivaAbrantes, Carlos Eduardo, Celia de Lima , Gilmar Ferreira Batalha, "Numerical Simulation of an aluminum alloy tube hydroforming",*Journal of Materials Processing Technology*, 179 ,pp 67 -73,2006 .
- [6]MikelJansson,Larsgunnar Nilsson, KjellSimonsson,"On process parameter estimation for the tube hydroforming process"*Journal of materials processing Technology* ,190 ,pp 1-11,2007 .
- [7]Y.M.Hwang , T.C.Lin , W.C. Change,"Experiments on T-Shape hydroforming with counter punch",*Journal of Materials Processing Technology* ,192,pp 243-248,2007 .
- [8] YannisP.Korkolisl., SteliosKyriakides,"Hydroforming of anisotropic aluminum tubes: Part I experiments",*International Journal of Mechanical Sciences*,53,pp75–82,2011 .
- [9] YannisP.Korkolisl.,SteliosKyriakides,"Hydroforming of anisotropic aluminum tubes: Part II analysis", *International Journal of Mechanical Sciences*,53,pp 83–90,2011 .
- [10] Johnson W., Mellor P.B., “Engineering Plasticity”, Van nostrandreinhold, 1988.
- [11] Marciniak Z., Duncan J.L., Hu S.J.,“ Mechanics of sheet metal forming” Butterworth Heinemann, pp152-163, 2002.
- [12] Pearson Prentice Hall, Robert L. Mott, “Machine Elements in Mechanical Design” , Fourth Edition, 2004.
- [13]Ansys 11 User Guide , 2010.
- [14] K.I. Johnson, B. N. Nguyen, R.W. Davies, G.J. Grant, and M.A. Khaleel, "A numerical process control method for circular tube hydroforming prediction", *International Journal of Plasticity*, 20,pp 1111–1137,2004.